

VOLKTEK

User Manual

SEN-9648P-24V/SEN-9648P-24V-SS/ SEN-9648PM-24V

8x 10/100/1000Base-T PoE+ & 4x Gigabit SFP slots
Managed Industrial Ethernet PoE+ Switch

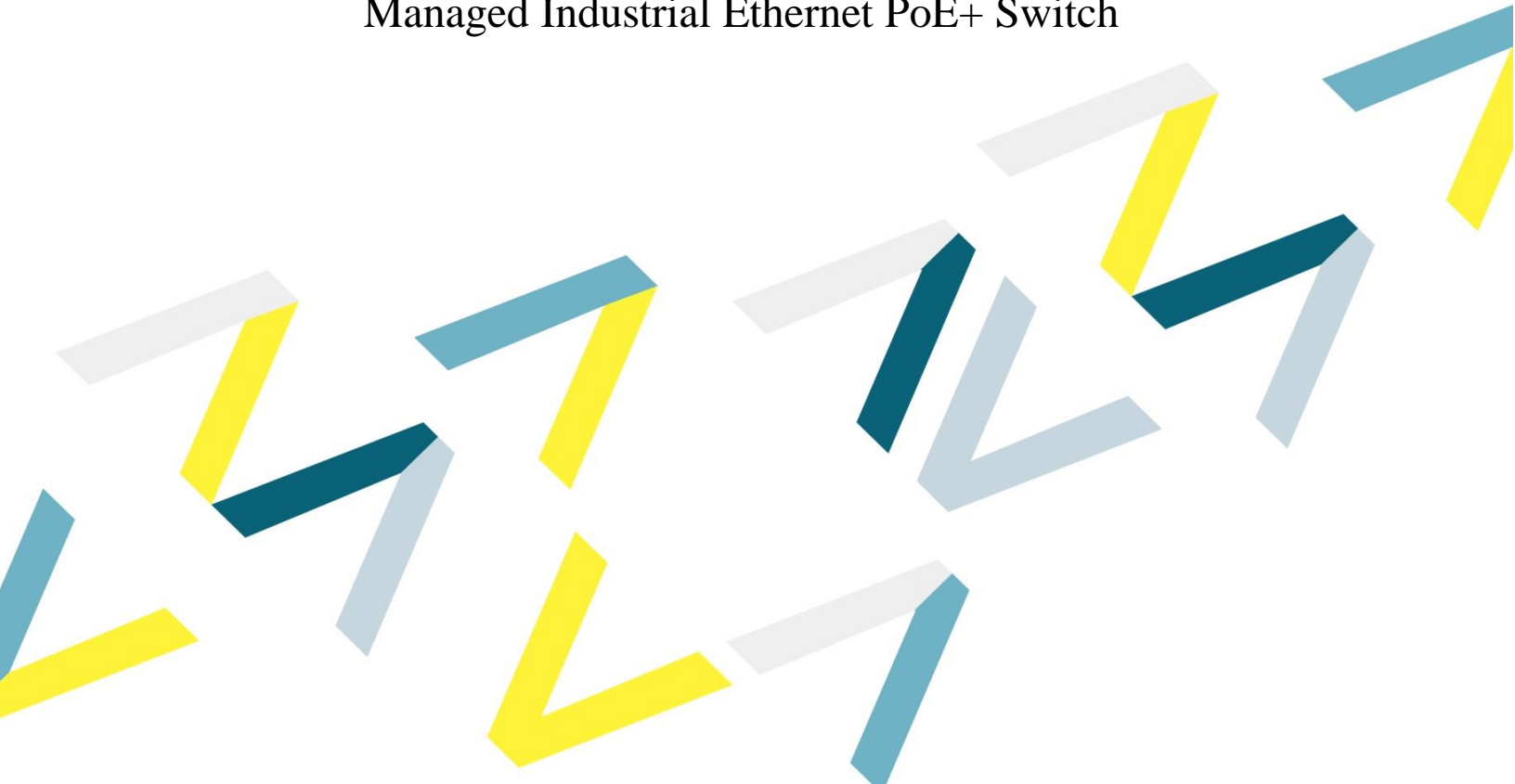

COPYRIGHT

All rights reserved. No part of this publication may be reproduced, stored in a retrieval system, or transmitted in any form or by any means, whether electronic, mechanical, photo copying, recording or otherwise, without the prior written permission of the publisher.

FCC WARNING



This equipment has been tested and found to comply with the limits for a class A device, pursuant to part 15 of FCC rules. These limits are designed to provide reasonable protection against harmful interference in a commercial installation.

This equipment generates uses and can radiate radio frequency energy and, if not installed and used in accordance with the instructions, may cause harmful interference to radio communication. Operation of this equipment in a residential area is likely to cause harmful interference, in which case, the user will be required to correct the interference at the user's own expense.

CE



This is a Class A product. In a domestic environment, this product may cause radio interference in which case the user may be required to take adequate measures.



HOT & COLD WARNING

The Switch surface will getting very hot or cold depend on the operating environment. Please take special care when touch to the working switch.



Warning

Take special care to read and understand all the content in the warning boxes.



Warning

Take special care to read and understand all the content in the warning boxes.



Warning

Do not work on the system or connect or disconnect cables during periods of lightning activity.



Warning

Before working on equipment that is connected to power lines, remove jewelry (including rings, necklaces, and watches). Metal objects will heat up when connected to power and ground and can cause serious burns or weld the metal object to the terminals.



Warning

Do not stack the chassis on any other equipment. If the chassis falls, it can cause severe bodily injury and equipment damage.



Warning

An exposed wire lead from a DC-input power source can conduct harmful levels of electricity. Be sure that no exposed portion of the DC-input power source wire extends from the terminal block plug.



Warning

Ethernet cables must be shielded when used in a central office environment.



Warning

If a redundant power system (RPS) is not connected to the switch, install an RPS connector cover on the back of the switch.



Warning

Read the wall-mounting instructions carefully before beginning installation. Failure to use the correct hardware or to follow the correct procedures could result in a hazardous situation to people and damage to the system.



Warning

Before performing any of the following procedures, ensure that power is removed from the DC circuit.



Warning

Read the installation instructions before connecting the system to the power source.



Warning

To prevent bodily injury when mounting or servicing this unit in a rack, you must take special precautions to ensure that the system remains stable. The following guidelines are provided to ensure your safety:

- This unit should be mounted at the bottom of the rack if it is the only unit in the rack.
- When mounting this unit in a partially filled rack, load the rack from the bottom to the top with the heaviest component at the bottom of the rack.
- If the rack is provided with stabilizing devices, install the stabilizers before mounting or servicing the unit in the rack.



Warning

This unit might have more than one power supply connection. All connections must be removed to de-energize the unit.



Warning

Only trained and qualified personnel should be allowed to install, replace, or service this equipment.



Warning

When installing or replacing the unit, the ground connection must always be made first and disconnected last.



Warning

Voltages that present a shock hazard may exist on Power over Ethernet (PoE) circuits if interconnections are made using uninsulated exposed metal contacts, conductors, or terminals. Avoid using such

interconnection methods, unless the exposed metal parts are located within a restricted access location and users and service people who are authorized within the restricted access location are made aware of the hazard. A restricted access area can be accessed only through the use of a special tool, lock and key or other means of security.



Warning

No user-serviceable parts inside. Do not open.



Warning

This equipment must be grounded. Never defeat the ground conductor or operate the equipment in the absence of a suitably installed ground conductor. Contact the appropriate electrical inspection authority or an electrician if you are uncertain that suitable grounding is available.

Table of Content

1. ABOUT THIS GUIDE.....	15
1.1. WELCOME	15
1.1.1. SEN-9648P-24V-RW.....	15
1.1.2. SEN-9648P-24V-SS	15
1.1.3. SEN-9648PM-24V	2
1.2. PURPOSE	2
1.3. TERMS/ USAGE	2
2. ABOUT THE SWITCH.....	3
2.1. FEATURES	3
2.2. SPECIFICATIONS	3
3. HARDWARE DESCRIPTION	5
3.1. CONNECTORS	5
3.2. INSTALLATION	6
3.3. LED INDICATORS	10
3.4. USB PORT	10
3.5. DIP SWITCHES.....	10
4. SYSTEM STATUS	13
4.1. CONSOLE PORT	13
4.2. TELNET	13
4.3. HOW TO ENTER THE CLI?	13
4.4. CLI COMMAND CONCEPT	14
4.4.1. COMMAND TABLE BRIEF	15
4.5. GUI LOGIN	17
4.6. SYSTEM INFORMATION	18
4.6.1. CLI CONFIGURATION.....	18
4.6.2. WEB CONFIGURATION	19
5. BASIC SETTINGS	21
5.1. GENERAL SETTINGS.....	21
5.1.1. SYSTEM.....	21
5.1.1.1. CLI CONFIGURATION.....	21
5.1.1.2. WEB CONFIGURATION	23
5.1.2. JUMBO FRAME	25
5.1.2.1. CLI CONFIGURATION.....	25
5.1.2.2. WEB CONFIGURATION	26
5.1.3. SNTP.....	26
5.1.3.1. CLI CONFIGURATION.....	27
5.1.3.2. WEB CONFIGURATION	28
5.1.4. MANAGEMENT HOST	30
5.1.4.1. CLI CONFIGURATION.....	30

5.1.4.2. WEB CONFIGURATION	31
5.2. MAC MANAGEMENT	32
5.2.1. STATIC MAC	33
5.2.1.1. CLI CONFIGURATION	33
5.2.1.2. WEB CONFIGURATION	33
5.2.2. MAC TABLE	34
5.2.2.1. CLI CONFIGURATION	34
5.2.2.2. WEB CONFIGURATION	35
5.2.3. AGE TIME SETTINGS	35
5.2.3.1. CLI CONFIGURATION	35
5.2.3.2. WEB CONFIGURATION	36
5.2.4. REFUSAL	37
5.2.4.1. CLI CONFIGURATION	37
5.2.4.2. WEB CONFIGURATION	38
5.3. PORT MIRROR	39
5.3.1. CLI CONFIGURATION	39
5.3.2. WEB CONFIGURATION	40
5.4 RSPAN	41
5.4.1 CLI COMMAND	41
5.4.2 CLI COMMAND EXAMPLE	41
5.4.3 WEB CONFIGURATION	42
5.5 PORT SETTINGS	43
5.5.1 GENERAL SETTINGS	44
5.5.1.1 CLI CONFIGURATION	44
5.5.1.2 WEB CONFIGURATION	46
5.5.2 INFORMATION	47
5.5.2.1 CLI CONFIGURATION	47
5.5.2.2 WEB CONFIGURATION	48
<u>6 ADVANCED SETTINGS</u>	<u>50</u>
6.4 BANDWIDTH CONTROL	50
6.4.1 QOS	50
6.4.1.1 PORT PRIORITY	53
6.4.1.1.1 CLI CONFIGURATION	53
6.4.1.1.2 WEB CONFIGURATION	53
6.4.1.2 IP DIFFSERV (DSCP)	54
6.4.1.2.1 CLI CONFIGURATION	56
6.4.1.2.2 WEB CONFIGURATION	56
6.4.1.3 PRIORITY/QUEUE MAPPING	58
6.4.1.3.1 CLI CONFIGURATION	58
6.4.1.3.2 WEB CONFIGURATION	59
6.4.1.4 SCHEDULE MODE	60
6.4.1.4.1 CLI CONFIGURATION	60
6.4.1.4.2 WEB CONFIGURATION	61
6.4.2 RATE LIMITATION	62
6.4.2.1 STORM CONTROL	62
6.4.2.1.1 CLI CONFIGURATION	62
6.4.2.1.2 WEB CONFIGURATION	63
6.4.2.2 BANDWIDTH LIMITATION	64
6.4.2.2.1 CLI CONFIGURATION	64

6.4.2.2.2	WEB CONFIGURATION	65
6.5	IGMP SNOOPING.....	66
6.5.1	IGMP SNOOPING	66
6.5.1.1	GENERAL SETTINGS.....	67
6.5.1.1.1	CLI CONFIGURATION.....	67
6.5.1.1.2	WEB CONFIGURATION	68
6.5.1.2	PORT SETTINGS	69
6.5.1.2.1	CLI CONFIGURATION.....	69
6.5.1.2.2	WEB CONFIGURATION	71
6.5.1.3	QUERIER SETTINGS.....	72
6.5.1.3.1	CLI CONFIGURATION.....	72
6.5.1.3.2	WEB CONFIGURATION	73
6.5.2	IGMP SNOOPING FILTERING.....	74
6.5.2.1	GENERAL SETTINGS.....	74
6.5.2.1.1	CLI CONFIGURATIONS	74
6.5.2.1.2	WEB CONFIGURATIONS	74
6.5.2.2	GROUP SETTINGS	75
6.5.2.2.1	CLI CONFIGURATIONS	75
6.5.2.2.2	WEB CONFIGURATIONS	76
6.5.2.3	PORT SETTINGS	77
6.5.2.3.1	CLI CONFIGURATIONS	77
6.5.2.3.2	WEB CONFIGURATIONS	77
6.5.3	MULTICAST LISTENER DISCOVERY (MLD) SNOOPING FOR IPV6.....	78
6.5.3.1	GENERAL SETTINGS.....	79
6.5.3.1.1	CLI CONFIGURATION.....	79
6.5.3.1.2	WEB CONFIGURATION	80
6.5.4	VLAN SETTINGS	81
6.5.4.1	CLI CONFIGURATION.....	81
6.5.4.2	WEB CONFIGURATION	82
6.5.5	MVR.....	83
6.5.5.1	MVR SETTINGS	85
6.5.5.1.1	CLI CONFIGURATION.....	85
6.5.5.1.2	WEB CONFIGURATION	86
6.5.5.2	GROUP SETTINGS	87
6.5.5.2.1	CLI CONFIGURATION.....	87
6.5.5.2.2	WEB CONFIGURATION	87
6.5.6	MULTICAST ADDRESS	88
6.5.6.1	CLI CONFIGURATION.....	90
6.5.6.2	WEB CONFIGURATION	90
6.6	VLAN.....	91
6.6.1	PORT ISOLATION	91
6.6.1.1	CLI CONFIGURATION.....	91
6.6.1.2	WEB CONFIGURATION	92
6.6.2	802.1Q VLAN	93
6.6.2.1	VLAN.....	94
6.6.2.1.1	CLI CONFIGURATION.....	94
6.6.2.1.2	WEB CONFIGURATION	96
6.6.2.2	TAG SETTINGS.....	97
6.6.2.2.1	CLI CONFIGURATION.....	97
6.6.2.2.2	WEB CONFIGURATION	98
6.6.2.3	PORT SETTINGS	99

6.6.2.3.1	CLI CONFIGURATION.....	99
6.6.2.3.2	WEB CONFIGURATION	100
6.6.3	GARP/GVRP.....	101
6.6.3.1	GVRP.....	102
6.6.3.1.1	CLI CONFIGURATION.....	102
6.6.3.1.2	WEB CONFIGURATION	103
6.6.3.2	GARP TIMER	104
6.6.3.2.1	CLI CONFIGURATION.....	104
6.6.3.2.2	WEB CONFIGURATION	104
6.6.4	IP SUBNET VLAN.....	105
6.6.4.1	CLI CONFIGURATION.....	105
6.6.4.2	WEB CONFIGURATION	106
6.6.5	MAC-BASED VLAN.....	107
6.6.5.1	CLI CONFIGURATION.....	107
6.6.5.2	WEB CONFIGURATION	108
6.6.6	PROTOCOL-BASED VLAN.....	109
6.6.6.1	CLI CONFIGURATION.....	109
6.6.6.2	WEB CONFIGURATION	110
6.6.7	Q-IN-Q VLAN (VLAN STACKING)	111
6.6.7.1	VLAN STACKING	116
6.6.7.1.1	CLI CONFIGURATION.....	116
6.6.7.1.2	WEB CONFIGURATION	117
6.6.7.2	PORT-BASED Q-IN-Q.....	118
6.6.7.2.1	CLI CONFIGURATION.....	118
6.6.7.2.2	WEB CONFIGURATION	119
6.6.7.3	SELECTIVE Q-IN-Q	120
6.6.7.3.1	CLI CONFIGURATION.....	120
6.6.7.3.2	WEB CONFIGURATION	121
6.6.8	VLAN TRANSLATION	122
6.6.8.1	CLI CONFIGURATION.....	122
6.6.8.2	WEB CONFIGURATION	123
6.7	DHCP OPTIONS.....	124
6.7.1	OPTION 66 AND 67	124
6.7.1.1	CLI CONFIGURATION.....	125
6.7.1.2	WEB CONFIGURATION	125
6.7.2	DHCP OPTION 82	126
6.7.2.1	CLI CONFIGURATION.....	128
6.7.2.2	WEB CONFIGURATION	129
6.8	DHCP RELAY	131
6.8.1	CLI CONFIGURATION.....	132
6.8.2	WEB CONFIGURATION	133
6.9	DUAL HOMING.....	134
6.9.1	CLI CONFIGURATION.....	134
6.9.2	WEB CONFIGURATION	135
6.10	ENERGY EFFICIENT ETHERNET (EEE).....	137
6.10.1	CLI CONFIGURATIONS	137
6.10.2	WEB CONFIGURATIONS	138
6.11	ERPS.....	139
6.11.1	RING.....	141
6.11.1.1	CLI CONFIGURATION.....	141
6.11.1.2	WEB CONFIGURATION	142

6.11.2	INSTANCE	143
6.11.2.1	CLI CONFIGURATION	143
6.11.2.2	WEB CONFIGURATION	144
6.12	LINK AGGREGATION	145
6.12.1	STATIC TRUNK	145
6.12.1.1	CLI CONFIGURATION	145
6.12.1.2	WEB CONFIGURATION	146
6.12.2	LACP	147
6.12.2.1	CLI CONFIGURATION	148
6.12.2.2	WEB CONFIGURATION	149
6.12.3	LACP INFORMATION	150
6.12.3.1	CLI CONFIGURATIONS	150
6.12.3.2	WEB CONFIGURATIONS	150
6.13	LOOP DETECTION.....	152
6.13.1	CLI CONFIGURATION	152
6.13.2	WEB CONFIGURATION	154
6.14	MODBUS TCP	156
6.14.1	CLI CONFIGURATION	159
6.14.2	WEB CONFIGURATION	160
6.15	POE (POWER OVER ETHERNET)	161
6.15.1	POE	161
6.15.1.1	CLI CONFIGURATION	163
6.15.1.2	WEB CONFIGURATION	164
6.15.2	PD ALIVE CHECK.....	166
6.15.2.1	CLI CONFIGURATION	166
6.15.2.2	WEB CONFIGURATION	167
6.15.3	POWER DELAY	168
6.15.3.1	CLI CONFIGURATION	168
6.15.3.2	WEB CONFIGURATION	169
6.15.4	POE SCHEDULE.....	170
6.15.4.1	CLI CONFIGURATION	170
6.15.4.2	WEB CONFIGURATION	171
6.16	PTP (IEEE-1588 V2).....	172
6.16.1	GENERAL SETTINGS.....	172
6.16.1.1	CLI CONFIGURATION	172
6.16.1.2	WEB CONFIGURATION	173
6.16.2	DOMAIN SETTINGS	174
6.16.2.1	CLI CONFIGURATION	174
6.16.2.2	WEB CONFIGURATION	176
6.16.3	PORT SETTINGS	178
6.16.3.1	CLI CONFIGURATION	178
6.16.3.2	WEB CONFIGURATION	179
6.17	PPPOE IA	181
6.17.1	GLOBAL CONFIGURATION.....	184
6.17.1.1	CLI CONFIGURATION	184
6.17.1.2	WEB CONFIGURATION	185
6.17.2	PORT CONFIGURATION.....	187
6.17.2.1	CLI CONFIGURATION	187
6.17.2.2	WEB CONFIGURATION	188
6.17.3	STATISTICS	190
6.17.3.1	CLI CONFIGURATION	190

6.17.3.2	WEB CONFIGURATION	190
6.18	STATIC ROUTE	192
6.18.1	CLI CONFIGURATION	192
6.18.2	WEB CONFIGURATION.....	195
6.19	STP.....	197
6.19.1	GENERAL SETTINGS.....	201
6.19.1.1	CLI CONFIGURATIONS	201
6.19.1.2	WEB CONFIGURATIONS	202
6.19.2	PORT PARAMETERS	203
6.19.2.1	CLI CONFIGURATIONS	203
6.19.2.2	WEB CONFIGURATIONS	205
6.19.3	STP STATUS	207
6.19.3.1	WEB CONFIGURATIONS	207
6.19.4	MSTP.....	208
6.19.4.1	GENERAL SETTINGS.....	210
6.19.4.1.1	CLI CONFIGURATIONS	210
6.19.4.1.2	WEB CONFIGURATIONS.....	212
6.19.4.2	BRIDGE PARAMETERS	213
6.19.4.2.1	CLI CONFIGURATIONS	213
6.19.4.2.2	WEB CONFIGURATIONS.....	214
6.19.4.3	PORT PARAMETERS	215
6.19.4.3.1	CLI CONFIGURATIONS	215
6.19.4.3.2	WEB CONFIGURATIONS.....	217
6.19.4.4	STP STATUS	219
6.19.4.4.1	CLI CONFIGURATIONS	219
6.19.4.4.2	WEB CONFIGURATIONS.....	219
6.20	UDLD.....	220
6.20.1	PORT SETTINGS	220
6.20.1.1	CLI CONFIGURATIONS	220
6.20.1.2	WEB CONFIGURATIONS	223
6.20.2	NEIGHBORS.....	224
6.20.2.1	CLI CONFIGURATIONS	224
6.20.2.2	WEB CONFIGURATIONS	224
6.21	XPRESS RING	225
6.21.1	CLI CONFIGURATION.....	225
6.21.2	WEB CONFIGURATION	226
7	<u>SECURITY.....</u>	228
7.4	SECURITY.....	228
7.4.1	IP SOURCE GUARD.....	228
7.4.1.1	DHCP SNOOPING.....	228
7.4.1.1.1	DHCP SNOOPING.....	231
7.4.1.1.1.1	CLI CONFIGURATIONS	231
7.4.1.1.1.2	WEB CONFIGURATIONS.....	231
7.4.1.1.2	PORT SETTINGS	233
7.4.1.1.2.1	CLI CONFIGURATIONS	233
7.4.1.1.2.2	WEB CONFIGURATIONS.....	234
7.4.1.1.3	SERVER SCREENING.....	235
7.4.1.1.3.1	CLI CONFIGURATIONS	235
7.4.1.1.3.2	WEB CONFIGURATIONS.....	235

7.4.2	BINDING TABLE	236
7.4.2.1	STATIC ENTRY	236
7.4.2.1.1	CLI CONFIGURATIONS	236
7.4.2.1.2	WEB CONFIGURATIONS	237
7.4.2.2	BINDING TABLE	238
7.4.2.2.1	CLI CONFIGURATIONS	238
7.4.2.2.2	WEB CONFIGURATIONS	238
7.4.3	ARP INSPECTION	240
7.4.3.1	ARP INSPECTION	240
7.4.3.1.1	CLI CONFIGURATIONS	240
7.4.3.1.2	WEB CONFIGURATIONS	241
7.4.3.2	FILTER TABLE	243
7.4.3.2.1	CLI CONFIGURATIONS	243
7.4.3.2.2	WEB CONFIGURATIONS	244
7.5	ACL.....	245
7.5.1	CLI CONFIGURATIONS	246
7.5.2	WEB CONFIGURATIONS	249
7.6	802.1X.....	251
7.6.1	GLOBAL SETTINGS.....	253
7.6.1.1	CLI CONFIGURATIONS	253
7.6.1.2	WEB CONFIGURATIONS	254
7.6.2	PORT SETTINGS	256
7.6.2.1	CLI CONFIGURATIONS	256
7.6.2.2	WEB CONFIGURATIONS	257
7.7	PORT SECURITY.....	259
7.7.1	PORT SECURITY	259
7.7.1.1	CLI CONFIGURATIONS	259
7.7.1.2	WEB CONFIGURATIONS	260
7.7.2	STICKY MAC	261
7.7.2.1	CLI CONFIGURATIONS	261
7.7.2.2	WEB CONFIGURATIONS	262
7.8	TACACS+.....	263
7.8.1	CLI CONFIGURATIONS	264
7.8.2	WEB CONFIGURATIONS	266
7.9	DENIAL OF SERVICE	268
7.9.1	CLI CONFIGURATION	268
7.9.1.1	CLI CONFIGURATION.....	268
7.9.2	WEB CONFIGURATION	269
8	<u>MONITOR.....</u>	<u>269</u>
8.4	ALARM	269
8.4.1	CLI CONFIGURATIONS	270
8.4.2	WEB CONFIGURATIONS	270
8.5	HARDWARE INFORMATION.....	271
8.5.1	CLI CONFIGURATIONS	271
8.5.2	WEB CONFIGURATIONS	272
8.6	PORT STATISTICS.....	273
8.6.1	CLI CONFIGURATIONS	273
8.6.2	WEB CONFIGURATIONS	273
8.7	PORT UTILIZATION	274

8.7.1	CLI CONFIGURATION	274
8.7.2	WEB CONFIGURATION	274
8.8	RMON STATISTICS	275
8.8.1	CLI CONFIGURATION	275
8.8.2	WEB CONFIGURATION	275
8.9	SFP INFORMATION	276
8.9.1	CLI CONFIGURATIONS	276
8.9.2	WEB CONFIGURATIONS	276
8.10	TRAFFIC MONITOR	277
8.10.1	CLI CONFIGURATIONS	277
8.10.2	WEB CONFIGURATIONS	279
8.11	TRAFFIC MONITOR	281
8.11.1	CLI COMMAND.....	281
8.11.1.1	CLI COMMAND EXAMPLE	281
8.11.2	WEB CONFIGURATION	281
8.11.2.1	GENERAL SETTINGS	282
8.11.2.2	FLOW SAMPLING SETTINGS.....	283
8.11.2.3	COUNT SAMPLING SETTINGS.....	284
9	<u>MANAGEMENT</u>	285
9.4	SNMP.....	285
9.4.1	SNMP	286
9.4.1.1	SNMP SETTINGS.....	286
9.4.1.1.1	CLI CONFIGURATIONS	286
9.4.1.1.2	WEB CONFIGURATIONS	286
9.4.1.2	COMMUNITY NAME	287
9.4.1.2.1	CLI CONFIGURATIONS	287
9.4.1.2.2	WEB CONFIGURATIONS	287
9.4.2	SNMP TRAP.....	289
9.4.2.1	TRAP RECEIVER.....	289
9.4.2.1.1	CLI CONFIGURATIONS	289
9.4.2.1.2	WEB CONFIGURATIONS	289
9.4.2.2	TRAP EVENT	290
9.4.2.2.1	CLI CONFIGURATIONS	290
9.4.2.2.2	WEB CONFIGURATIONS	291
9.4.2.3	PORT TRAP EVENT	292
9.4.2.3.1	CLI CONFIGURATIONS	292
9.4.2.3.2	WEB CONFIGURATIONS	292
9.4.3	SNMPV3.....	293
9.4.3.1	GROUP SETTINGS	293
9.4.3.1.1	CLI CONFIGURATIONS	293
9.4.3.1.2	WEB CONFIGURATIONS	294
9.4.3.2	USER SETTINGS	295
9.4.3.2.1	CLI CONFIGURATIONS	295
9.4.3.2.2	WEB CONFIGURATIONS	296
9.4.3.3	VIEW SETTINGS	297
9.4.3.3.1	CLI CONFIGURATIONS	297
9.4.3.3.2	WEB CONFIGURATIONS	297
9.5	AUTO PROVISION	298
9.5.1	CLI CONFIGURATIONS	299

9.5.2	WEB CONFIGURATIONS	300
9.6	MAIL ALARM	301
9.6.1	CLI CONFIGURATIONS	301
9.6.2	WEB CONFIGURATIONS	302
9.7	MAINTENANCE	303
9.7.1	CONFIGURATION	303
9.7.1.1	CLI CONFIGURATIONS	303
9.7.1.2	WEB CONFIGURATIONS	305
9.7.2	FIRMWARE	307
9.7.2.1	CLI CONFIGURATIONS	307
9.7.2.2	WEB CONFIGURATIONS	307
9.7.3	REBOOT	308
9.7.3.1	CLI CONFIGURATIONS	308
9.7.3.2	WEB CONFIGURATIONS	308
9.7.4	SERVER CONTROL.....	309
9.7.4.1	CLI CONFIGURATIONS	309
9.7.4.2	WEB CONFIGURATIONS	310
9.8	SYSLOG	311
9.8.1	CLI CONFIGURATIONS	311
9.8.2	WEB CONFIGURATIONS	312
9.9	USB FUNCTION.....	313
9.9.1	CLI CONFIGURATIONS	313
9.9.2	WEB CONFIGURATIONS	313
9.10	USER ACCOUNT	315
9.10.1	CLI CONFIGURATIONS	315
9.10.2	WEB CONFIGURATIONS	316
9.11	DEVICE MANAGEMENT.....	317
9.11.1	LLDP	317
9.11.1.1	CLI CONFIGURATIONS	317
9.11.1.2	WEB CONFIGURATIONS.....	318
9.11.2	MANUAL REGISTRATION.....	320
9.11.2.1	CLI CONFIGURATIONS	320
9.11.2.2	WEB CONFIGURATIONS.....	320
9.11.3	ONVIF.....	322
9.11.3.1	CLI CONFIGURATIONS	322
9.11.3.2	WEB CONFIGURATIONS.....	322
9.12	TOPOLOGY MAP.....	324
9.12.1	BACKGROUND CONFIGURATION.....	326
9.12.2	CLIENT-SWITCH MANAGEMENT.....	326
10	<u>MISC</u>	<u>328</u>
10.4	CABLE TEST.....	328
10.4.1	CLI CONFIGURATIONS	328
11	<u>VOLKTEK SUPPORT</u>	<u>329</u>
11.4	CONTACT INFORMATION.....	329
11.5	FAQ'S.....	331
11.6	MANUAL.....	331
11.7	SUPPORT.....	332

11.8 VOLKTEK WEBSITE..... 332

1. About this Guide

1.1. Welcome

The SEN-9648P-24V-RW/SEN-9648P-24V-SS/SEN-9648PM-24V is a Managed Industrial PoE+ Switch perfectly suited for industrial network applications which require managed devices that offer hassle-free fiber deployment and an ideal solution to deploy in automation as well as surveillance systems. The switch is designed to meet the requirements of both power and data transmission over single Ethernet cable to PoE appliances and devices without the need for power outlets, eliminating additional cost of electrical cabling and circuits. The switch's rugged IP40 aluminum case and hardened components withstand in operating temperatures from -40°C to 75°C.

The SEN-9648P-24V-RW/SEN-9648P-24V-SS/SEN-9648PM-24V features with 4 Gigabit SFP slots to insert fiber port which is immune to moisture, static electricity, power surges and short circuits, plus 8 10/100/1000Base-T PoE+ ports. Each of the PoE ports complies with the IEEE 802.3at standard allowing them to supply up to 30W to satisfy the growing demand of high power consuming network devices such as WLAN AP, VoIP phones and IP surveillance cameras, and other powered devices in longer distances up to 100 meters with Cat 5e cables.

1.1.1. SEN-9648P-24V-RW

SEN-9648P-24V-RW switches are designed to meet the demands of railway applications, including rolling stock and wayside installations. The switches guarantee reliable operation in industrial environments where vibration and shock are common place. Gigabit backbone, redundant ring increase the reliability of the communications and reduce cabling and wiring costs. These are compliant with mandatory sections of EN 50155, covering operating temperature, power input voltage, surge, ESD, and vibration, as well as conformal coating and power insulation, making the switches suitable for a variety of Railway applications.

1.1.2. SEN-9648P-24V-SS

SEN-9648P-24V-SS switch is designed to meet the demands of power substation automation systems (IEC 61850-3, IEEE 1613). The switches guarantee reliable operation in critical environments where vibration and shock are common place. Gigabit backbone, redundant ring increase the reliability of the communications and reduce cabling and wiring costs. These are

compliant with mandatory sections of IEEE 1613, covering operating temperature, power input voltage, surge, ESD, and vibration, as well as conformal coating and power insulation, making the switches suitable for a variety of Sub-station applications.

1.1.3. SEN-9648PM-24V

SEN-9648PM-24V switch is designed to meet the demands of power substation automation systems (IEC 61850-3, IEEE 1613). The switches guarantee reliable operation in critical environments where vibration and shock are common place. Gigabit backbone, redundant ring increase the reliability of the communications and reduce cabling and wiring costs. These are compliant with mandatory sections of IEEE 1613, covering operating temperature, power input voltage, surge, ESD, and vibration, as well as conformal coating and power insulation, making the switches suitable for a variety of Sub-station applications.

1.2. Purpose

This guide discusses how to install and configure your Managed Industrial PoE+ Switch.

1.3. Terms/ Usage

In this guide, the term “Switch” (first letter upper case) refers to the SEN-9648P-24V-RW/ SEN-9648P-24V-SS / SEN-9648PM-24V Switch, and “switch” (first letter lower case) refers to other switches.

2. About the Switch

2.1. Features

Network Functions

Port-based Mirroring
RSPAN
GARP/GVRP Support
4K Active VLAN
IGMP Snooping v1/v2/v3
IGMP Querier
MVR
DHCP Relay/Option 82
Dual Homing
Link Aggregation
Link Layer Discovery Protocol
Loop Detection, Auto Recovery Timer
STP/RSTP/MSTP
Xpress Ring
ERPS (G8032v2)
SFP DDMI Support
RMON Statistics
sFlow
Static Route
Multicast Listener Discovery (MLD)
Snooping
PTP (IEEE-1588 v2)

Network Security

Access Control List (L2/L3/L4)

MAC Limitation
Port Security
802.1x Port Authentication
TACACS+
Denial of Service

Traffic management & QoS

Port Priority
Rate Limitation
Storm Control
Port Isolation
802.1Q Tag-based VLAN
Auto MDI/MDI-X

Network Management

Command Line Interface, Telnet
Web GUI
SNMP v1/v2c/v3
Management VLAN
Remote system log
Firmware Upgradable
Configuration Upload/Download
LED, SNMP trap, and email alarm
USB 2.0 support for firmware and configuration upgrade

2.2. Specifications

IEEE Standards

IEEE 802.3	10Base-T
IEEE 802.3u	100Base-TX
IEEE 802.3ab	1000Base-T
IEEE 802.3z	1000Base-SX/LX
IEEE 802.3x	Flow Control
IEEE 802.1D	Spanning Tree Protocol

IEEE 802.1w
 IEEE 802.1s
 IEEE 802.1Q
 IEEE 802.1p
 IEEE 802.1X
 IEEE 802.1AB
 IEEE 802.3ad
 IEEE 1588v2
 IEEE 802.3af
 IEEE 802.3at
 ITU-T G.8032v1/v2

Rapid Spanning Tree Protocol
 Multiple Spanning Tree Protocol
 VLAN Tagging
 Class of Service
 Port Authentication
 Link Layer Discovery Protocol
 Port Trunk with LACP
 Precision Time Protocol
 Power over Ethernet (PoE)
 High Power over Ethernet (PoE+)
 Ethernet Ring Protection Switching

Performance

Switching fabric	24Gbps
L2 forwarding	17.86Mpps
Packet Buffer size	8Mbits
MAC Entries	16 K
Jumbo frame	10 K
Throughput	1,488,000pps when 1000Mbps speed

Ports

10/100/1000Base-T (PSE)	8
Gigabit SFP slots	4
Console port (RJ45 to RS232)	1
USB port	1

Power

Input Voltage:

- Primary inputs 24~57VDC at a maximum of 6A
- Redundant inputs 24~57VDC at a maximum of 6A

Connection:

Removable 6-pin terminal block	one
Overload current protection	Support
Reverse Polarity Protection	Support
Relay output	One with current carrying capacity of 1 A @ 24VDC
System-power consumption	18W

Mechanical

Dimension (WxHxD)	50x160x120mm (1.97x6.36x4.81 inch)
Weight	955g
Mounting	DIN-Rail

Housing	IP40 protection
Operating Requirement	
Operating temperature	--40°C to 75°C
Storage temperature	-45°C to 85°C
Operating humidity	10% to 95% RH (Non Condensing)
Storage humidity	5% to 95% RH (Non Condensing)

PoE

Power Available at PD	25.50W
Max Power delivered by PSE	30 W
Voltage Range (at PSE)	24-57V
Voltage Range (at PD)	50-57V
Maximum Current	600mA
Maximum Cable resistance	12.5 Ω (Category 5)
Output capacity for PoE	240W (48VDC), 120W (24VDC)
PoE supported mode	Mode A

Note: PoE budget at 24V input is 120W. If all the 8 ports are connected then power delivered by PSE is 15W. If only 4 ports are connected then power delivered by PSE is 30W

DIN RAIL Recommendation

Steel with Electrolytic Zinc Plating
Stand-Off Brackets: 45⁰ Angle and Straight
Comply with EN 50045, 50022 and 50035 Standards

3. Hardware Description

3.1. Connectors

The Switch utilizes ports with copper and SFP fiber port connectors functioning under Ethernet/Fast Ethernet/Gigabit Ethernet standards.

10/100/1000Base-T Ports

The 10/100/1000Base-T ports support network speeds of 10Mbps, 100Mbps or 1000Mbps, and can operate in half- and full-duplex transfer modes. These ports also offer automatic MDI/MDI-X crossover detection that gives true “plug-n-play” capability – just plug the network cables into the ports and the ports will adjust according to the end-node devices. The following are recommended cabling for the RJ45 connectors: (1) 10Mbps – Cat 3 or better; (2) 100/1000Mbps – Cat 5e or better.

SFP Slots for SFP modules

The four SFP slots are designed to Gigabit SFP modules that support network speed of 1000Mbps.

Installing the SFP modules and Fiber Cable

1. Slide the selected SFP module into the selected SFP slot (Make sure the SFP module is aligned correctly with the inside of the slot)
2. Insert and slide the module into the SFP slot until it clicks into place
3. Remove any rubber plugs that may be present in the SFP module’s mouth
4. Align the fiber cable’s connector with the SFP module’s mouth and insert the connector
5. Slide the connector in until a click is heard
6. If you want to pull the connector out, first push down the release clip on top of the connector to release the connector from the SFP module.

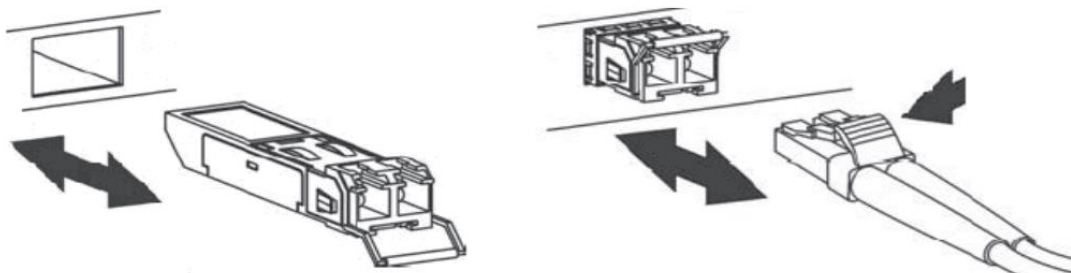

To properly connect fiber cabling: Check that the fiber terminators are clean. You can clean the cable plugs by wiping them gently with a clean tissue or cotton ball moistened with a little ethanol. Dirty fiber terminators on fiber optic cables will impair the quality of the light transmitted through the cable and lead to degraded performance on the port.

Note: When inserting the cable, be sure the tab on the plug clicks into position to ensure that it is properly seated.

Check the corresponding port LED on the Switch to be sure that the connection is valid. (Refer to the LED chart).

3.2. Installation

The location chosen for installing the Switch may greatly affect its performance. When selecting, we recommend considering the following rules:

- ✓ Install the Switch in an appropriate place. See Technical Specifications for the acceptable temperature and humidity ranges.
- ✓ Install the Switch in a location that is not affected by strong electromagnetic field generators (such as motors), vibration, dust, and direct sunlight.
- ✓ Leave at least 10cm of space at the front and rear of the unit for ventilation.

ATTENTION:



The SEN-9648P-24V-RW/SEN-9648P-24V-SS/SEN-9648PM-24V is an open type device and SEN-9648P-24V-RW/SEN-9648P-24V-SS/SEN-9648PM-24V shall be DIN-Rail mounted or wall mounted (optional) in cabinet or enclosure

Hardware Installation

- ✓ **Step 1:** Unpack the device and other contents of the package.
- ✓ **Step 2:** Fasten DIN-Rail or Wall-mount kit on the rear of the SEN-9648P-24V-RW/SEN-9648P-24V-SS/SEN-9648PM-24V
- ✓ **Step 3:** Connect the 24~57V DC power to the PWR & RPS terminal block.
- ✓ **Step 4:** Connect the Ethernet (RJ45) port to the networking device and check the LED status to confirm the connection is established.

DIN rail Installation

The SEN-9648P-24V-RW/SEN-9648P-24V-SS/SEN-9648PM-24V has a DIN rail bracket on the back of the Switch.

Location: The SEN-9648P-24V-RW/SEN-9648P-24V-SS/SEN-9648PM-24V can be DIN-Rail-mounted in cabinet or enclosure.

Mounting the switch

Place the SEN-9648P-24V-RW/SEN-9648P-24V-SS/SEN-9648PM-24V on the DIN rail from above using the slot. Push the front of the switch toward the mounting surface until it snaps into place with a click sound.

Dismounting the switch

Pull out the lower edge of the switch and then remove the switch from the DIN rail.

Ground the Switch: Before powering on the switch, ground the switch to earth.

Ensure the rack on which the switch is to be mounted is properly grounded and in compliance with ETSI ETS 300 253. Verify that there is a good electrical connection to the grounding point on the rack (no paint or isolating surface treatment).

ATTENTION



This product is intended to be mounted to a well-grounded mounting surface such as a metal panel.

CAUTION



The earth connection must not be removed unless all power supply connection has been disconnected.

The device is installed in a restricted-access location it has a separate protective earthing terminal on the chassis that must be permanently connected to earth ground to adequately ground the chassis and protect the operator from electrical hazards.

ATTENTION



The product should be mounted in an Industrial Control Panel and the ambient temperature should not exceed 75°C.

ATTENTION



A corrosion-free mounting rail is advisable.

When installing, make sure to allow for enough space to properly install the cabling.

Wiring Power Inputs

You can use “Terminal Block (PWR)” for Primary Power input and “Terminal Block (RPS)” for secondary power source for Redundant Power Input.

To insert power wire and connect the 24/48VDC power to the power terminal block, follow the steps below:

- ✓ **Step 1:** Insert the positive/negative DC wires into the V-/V+ terminal, respectively.
- ✓ **Step 2:** Use your finger to press the green plug on top of terminal block connector to insert power cables.
- ✓ **Step 3:** Insert the terminal block connector which includes “PWR” and “RPS” into the terminal block receptor which is located on the top panel.

WARNING



- Use **copper** conductors only, **60/75°C**, tighten to **5lb**
- The wire gauge for the terminal block should range between **12~24 AWG**.

Redundant Power Input: You can use “Terminal Block (PWR)” as primary power and “Terminal Block (RPS)” for redundant power.

Connect power cables to terminal block: Use your finger to press the orange plug on top of terminal block connector to insert power cables

WARNING



Safety measures should be taken before connecting the power cable. Turn off the power before connecting modules or wires. The correct power supply voltage is

listed on the product label. Check the voltage of your power source to make sure that you are using the correct voltage. **DO NOT** use a voltage greater than what is specified on the product label. Calculate the maximum possible current in each power wire and common wire. Observe all electrical codes dictating the maximum current allowable for each wire size. If current exceeds the maximum rating, the wiring can overheat causing serious damage to your equipment.

Please read and follow these guidelines:

- Use separate paths to route wiring for power and devices. If power wiring and device wiring paths must cross, make sure the wires are perpendicular at the intersection point. **NOTE:** Do not run signal or communications wiring and power wiring through the same wire conduit. To avoid interference, wires with different signal characteristics should be routed separately.
- You can use the type of signal transmitted through a wire to determine which wires should be kept separate. The rule of thumb is that wiring that shares similar electrical characteristics can be bundled together
- You should separate input wiring from output wiring
- We advise that you label the wiring to all devices in the system.

Wiring the Alarm Contact:

The Alarm Contact consists of the two last contacts of the terminal block on switch's top panel. **ALM:** The two last contacts of the 6-contact terminal block connector are used to detect both power faults and port faults. The two wires attached to the ALM contacts form an open circuit when:

1. The Switch has lost power from one of the DC power inputs.
- OR
2. One of the ports for which the corresponding PORT ALARM DIP Switch is set to ON is not properly connected.

If neither of these two conditions is satisfied, the Fault circuit will be closed.

WARNING



- Use **copper** conductors only, **60/75°C**, tighten to **5lb**
- The wire gauge for the terminal block should range between **12~24 AWG**.

Powering On the Unit

The Switch accepts the power input voltage from 24~57VDC.

- ✓ Insert the power cables into the terminal block located on the top of the device.
- ✓ Check the front-panel LEDs as the device is powered on to verify that the Power LED is lit. If not, check that the power cable is correctly and securely plugged in.

NOTICE: Turn off the power before connecting modules or wires.

- *The correct power supply voltage is listed on the product label. Check the voltage of your power source to make sure that you are using the correct voltage. Do NOT use a*

voltage greater than what is specified on the product label.

- *Calculate the maximum possible current in each power wire and common wire. Observe all electrical codes dictating the maximum current allowable for each wire size. If current go above the maximum ratings, the wiring could overheat, causing serious damage to your equipment.*

Reset Button

There has “Reset” button in front of Switch which can help to manually hardware reboot.

3.3. LED Indicators

This Switch is equipped with Unit LEDs to enable you to determine the status of the Switch, as well as Port LEDs to display what is happening in all your connections. They are as follows:

LED	Condition	Status
PWR (Green)	Illuminated	Primary power on
	Off	Primary power off or failure
RPS (Green)	Illuminated	Redundant power on
	Off	Redundant power off or failure
ALM (Red)	Illuminated	Alarm triggered for abnormal power status and anomalous features.
	Off	Normal operation
POST (Green)	Illuminated	Switch is ready or running
	Blinking	Self-testing the device when power on
	Off	Switch is not ready
PoE (Green) (1~8 th PoE port)	Illuminated	PoE power is delivered to powered device (PD)
	Off	PoE power feeding is off or not supplied
1000 (Green) (1~8 th RJ45 port)	Illuminated	Link speed at 1000Mbps
	Off	Link speed at 10/100Mbps
LNK/ACT (Green) (1~12 th port)	Illuminated	Port link-up
	Blinking	Activity (receiving or transmitting data)
	Off	Port disconnected or link failed

3.4. USB port

USB device can be inserted for auto firmware up-gradation. Switch auto-checks the firmware version present in the USB device and upgrades if newer version of Firmware is present.

3.5. DIP Switches

- Power: DIP 1 and DIP 2 is for primary power and redundant power supply.
-

No	Name	Description
1	PWR	ON: Primary power alarm reporting is enabled OFF: Primary power alarm reporting is disabled
2	RPS	ON: Redundant power alarm reporting is enabled OFF: Redundant power alarm reporting is disabled

About Railway Certification

What is EN 50155, EN 50121-4, and EN 61373

- EN 50155:2017 is an international standard for railway rolling stock applications which include temperature, humidity, shock, vibration, and environmental parameters for electronic equipment.
- EN 50121: is an electrical standard used for Electromagnetic compatibility test in Railway applications. Moreover, it will check the emission and immunity of the signaling and telecommunications apparatus such as switch.
- EN 61373 is a testing standard for railway vehicles to test vibrations and shock on the electronic equipment which can satisfy the quality of the equipment.

Why EN 50155 and EN 50121-4 and EN 61373

- Those International Standards specifies the requirements for testing items of equipment intended for use on railway vehicles which are eventually subjected to vibrations, shock and environmental factors owing to the nature of railway operational environment.
- To gain assurance that the quality of the equipment is acceptable, it has to endure tests of acceptable duration that simulate the service conditions of the switch seen throughout its expected life.

Benefits of EN 50155 and EN 50121-4 and EN 61373

- Passenger and Railway Traffic Safety: By maintaining the standard we assure the passenger and railway safety as the switch is well tested in EMI and EMS.
- Product Efficiency: The standard applies to all the products to achieve operational efficiency and adapt to different environmental condition including temperature, humidity, altitude, vibration, and Surge, etc.

About Sub Station Certification

What is IEC 61850-3, and IEEE 1613

- 61850 is an international standard for defining the communication protocols for intelligent switches at electrical substation environment.
- 61850 support MMS (Manufacturing Message Specification), GOOSE (Generic Object Oriented Substation Event), and SMV (Sampled Measured Values) protocols.
- IEEE 1613: is the IEEE Power & Energy Society standard for environmental and testing requirements of communications networking devices such as switch in electric substations.

Why IEC 61850-3, and IEEE 1613

- Performance: IEC 61850 standard prioritizes the packets based on GOOSE and SMV type for mission-critical operations.
- Reliability: IEEE 1613 standard guaranty a reliable communication in a hearse environmental condition.
- Interoperability: As a common format is maintained for data storage, there is a chance of high interoperability between systems from different vendors.

Benefits of IEC 61850-3, and IEEE 1613

- Reporting Schemes: Various reporting schemes such as BRCB and URCB for reporting data from a server through a server-client relationship.

- Fast Transfer of events: Generic Substation Events (GSE) is defined for fast transfer of event data using GOOSE and SMV for a peer-to-Peer communication.
- Data Storage: Substation Configuration Language (SCL) is defined for complete storage of configured data of the substation in a specific format.

4. System Status

4.1. Console Port

- Connect your computer to the console port on the Switch using the appropriate cable.
- Use terminal emulation software with the following settings:

Default Settings for the Console Port

Setting	Default Value
Terminal Emulation	VT100
Baud Rate	38400
Parity	None
Number of Data Bits	8
Number of Stop Bits	1
Flow Control	None

- Press [ENTER] to open the login screen.

Setting	Default Value
Default Username	admin
Default Password	admin

4.2. Telnet

- Connect your computer to one of the Ethernet ports.
- Open a Telnet session to the Switch's IP address. If this is your first login, use the default values.

Default Management IP Address

Setting	Default Value
IP Address	192.168.0.254
Subnet Mask	255.255.255.0
Default Gateway	0.0.0.0
Management VLAN	1
Default Username	admin
Default Password	admin

- Make sure your computer IP address is in the same subnet, unless you are accessing the Switch through one or more routers.

4.3. How to enter the CLI?

Press [Enter] key to enter the login command prompt when below message is displayed on the screen.

Please press Enter to activate this console

Input "*admin*" to enter the CLI mode when below message is displayed on the screen.

L2SWITCH login:

You can execute a few limited commands when CLI prompt is displayed as below.

L2SWITCH>

If you want to execute more powerful commands, you must enter the privileged mode.

Input command “*enable*”

L2SWITCH>enable

Input a valid username and password when below prompt are displayed.

user:admin

password:admin

L2SWITCH#

4.4. CLI command concept

Node	Command	Description
enable	show hostname	This command displays the system’s network name.
configure	reboot	This command reboots the system.
eth0	ip addressA.B.C.D/M	This command configures a static IP and subnet mask for the system.
interface	show	This command displays the current port configurations.
acl	show	This command displays the current access control profile.
vlan	show	This command displays the current VLAN configurations.

The Node type:

- enable
Its command prompt is “**L2SWITCH#**”.
It means these commands can be executed in this command prompt.
- configure
Its command prompt is “**L2SWITCH(config)#**”.
It means these commands can be executed in this command prompt.
In **Enable** code, executing command “**configure terminal**” enter the configure node.
L2SWITCH#configure terminal
- eth0
Its command prompt is “**L2SWITCH(config-if)#**”.
It means these commands can be executed in this command prompt.
In **Configure** code, executing command “**interface eth0**” enter the eth0 interface node.
L2SWITCH(config)#interface eth0
L2SWITCH(config-if)#
- interface
Its command prompt is “**L2SWITCH(config-if)#**”.
It means these commands can be executed in this command prompt.

In *Configure* code, executing command “*interface gig Ethernet1/0/5*” enter the interface port 5 node.

Or

In *Configure* code, executing command “*interface fast Ethernet1/0/5*” enter the interface port 5 node.

Note: depend on your port speed, gig Ethernet1/0/5 for gigabit Ethernet ports and fast Ethernet1/0/5 for fast Ethernet ports.

```
L2SWITCH(config)#interface gig Ethernet1/0/5
L2SWITCH(config-if)#
```

- vlan

Its command prompt is “*L2SWITCH(config-vlan)#*”.

It means these commands can be executed in this command prompt.

In *Configure* code, executing command “*vlan 2*” enter the vlan 2 node.

Note: where the “2” is the vlan ID.

```
L2SWITCH(config)#vlan 2
L2SWITCH(config-vlan)#
```

- acl

Its command prompt is “*L2SWITCH(config-acl)#*”.

It means these commands can be executed in this command prompt.

In *Configure* code, executing command “*access-list test*” enter the access-list test node.

Note: where the “test” is the profile name.

```
L2SWITCH(config)#access-list test
L2SWITCH(config-acl)#
```

4.4.1. Command table brief

Node	Prompt	Enter Command	Parent Node
enable	L2SWITCH#		
config	L2SWITCH(config)#	configure terminal	enable
acl	L2SWITCH(config-acl)#	access-list name NAME ip-type ipv4	config
acl	L2SWITCH(config-acl-ipv6)#	access-list name NAME ip-type ipv6	config
auto provision	L2SWITCH(auto-provision)#	auto-provision	config
eth0	L2SWITCH(config-if)#	interface eth0	config
dhcp server	L2SWITCH(config-erps-inst)#	dhcp-server pool POOL_ID	config
dhcp ipv6 server	L2SWITCH(config-erps-inst)#	dhcpv6-server pool POOL_ID	config
dhcp ipv6 server	L2SWITCH(config-erps-inst)#	vendor-specific	dhcp ipv6

vendor		VENDOR_ID	server
erps	L2SWITCH(config-erps-ring)#	erps ring-id RING_ID	config
erps instance	L2SWITCH(config-erps-inst)#	erps instance	config
interface range	L2SWITCH(config-if-range)#	interface range gigabitethernet1/0/ PORTLIST	config
vlan debug	L2SWITCH(if-vlan-debug)#	interface vlan-debug VLAN_ID	config
pppoe vlan	L2SWITCH(if-pppoe-vlan)#	pppoe intermediate-agent vlan VLAN_ID	config
inter vlan route	L2SWITCH(config-if-vlan-l3)#	interface vlan 2	config
igmp filter	L2SWITCH(config-igmp)#	igmp-snooping filtering profile NAME	config
interface	L2SWITCH(config-if)#	interface gigabitethernet1/0/2	config
mlds	L2SWITCH(config-mlDs)#	mld-snooping vlan VLAN_ID	config
mrp	L2SWITCH(config-mrp)#	mrp ring-id RING_ID	config
mstp	L2SWITCH(config-mst)#	spanning-tree mst configuration	config
mvr	L2SWITCH(config-mvr)#	mvr VLAN_ID	config
ptp	L2SWITCH(config-ptp)#	ptp domain DOMAIN_ID	config
ptp-port	L2SWITCH(config-ptp-port)#	port PORT_ID	ptp
qinq	L2SWITCH(config-qinq)#	vlan-stacking selective-qinq NAME	config
vlan	L2SWITCH(config-vlan)#	vlan VLAN_ID	config
vlan-range	L2SWITCH(config-vlan-range)#	vlan range VLAN_ID_LIST	config

4.5. GUI Login

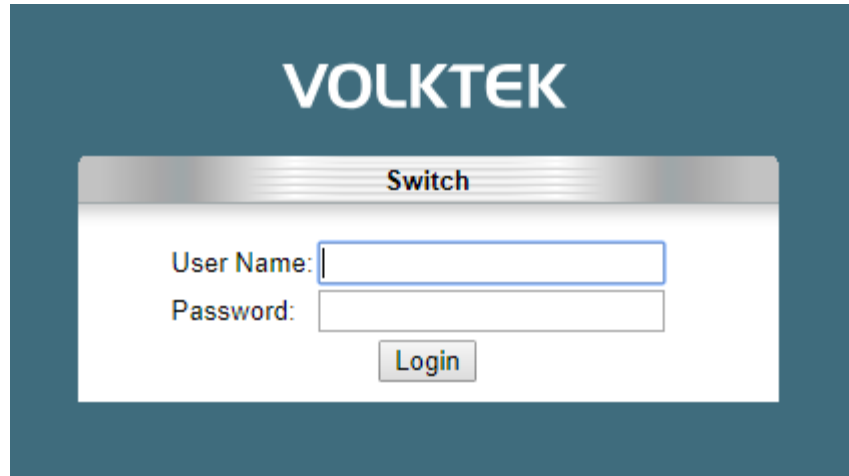

Parameter	Description
User ID	Enter the user name.
Password	Enter the password.

Default:

User name: admin,
Password: admin.

4.6. System Information

4.6.1. CLI Configuration

Node	Command	Description
enable	show hostname	This command displays the system's network name.
enable	show interface eth0	This command displays the current Eth0 configurations.
enable	show model	This command displays the system information.
enable	show running-config	This command displays the current operating configurations.
enable	show system-info	This command displays the system's CPU loading and memory information.
enable	show uptime	This command displays the system up time.

4.6.2. Web Configuration

The System Information window appears each time you log into the program. Alternatively, this window can be accessed by clicking System Status > System Information

System Information

System Information

Model Name	SEN-9648P
Hostname	L2SWITCH
Boot Code Version	V1.4.2.S0
Current Running Firmware	Primary Firmware
Primary Firmware:	
Version	V1.0.5.S0
Built Date	Tue Dec 7 18:24:55 CST 2021
Checksum	9791ef1a
Secondary Firmware:	
Version	V1.0.5.S0
Built Date	Tue Dec 7 18:23:30 CST 2021
Checksum	d5ab3b5f
DHCP Client	Enabled
IP Address	192.168.202.171
Subnet Mask	255.255.255.0
Default Gateway	192.168.202.1
MAC Address	90:f0:52:68:0c:68
Serial Number	A000000000001
Management VLAN	1
CPU Loading	<div style="display: inline-block; width: 100px; height: 10px; background: linear-gradient(to right, blue, gray);"></div> 10 %
Memory Information	Total: 513964 KB, Free: 474520 KB, Usage: 7.67 %
Current Time	2020-1-1, 0:0:36
System Uptime	0 days, 0 hours, 1 minutes, 16 seconds
DHCPv6 Client	Disabled
IPv6 Local Address	fe80::92f0:52ff:fe68:c68/64
IPv6 Default Gateway	
IPv6 Global Address	

Parameter	Description
System Information	
Model Name	This field displays the model name of the Switch.
Host name	This field displays the name of the Switch.
Boot Code Version	This field displays the boot code version.
Current Running Firmware	This field displays the current running firmware, primary or secondary.

Primary Firmware	
Version	This field displays the version of primary firmware.
Built Date	This field displays the built date of primary firmware.
Checksum	This field displays the checksum of primary firmware.
Secondary Firmware	
Version	This field displays the version of secondary firmware.
Built Date	This field displays the built date of econdary firmware.
Checksum	This field displays the checksum of secondary firmware.
DHCP Client	This field displays whether the DHCP client is enabled on the Switch.
IP Address	This field indicates the IP address of the Switch.
Subnet Mask	This field indicates the subnet mask of the Switch.
Default Gateway	This field indicates the default gateway of the Switch.
MAC Address	This field displays the MAC (Media Access Control) address of the Switch.
Serial Number	The serial number assigned by manufacture for identification of the unit.
Management VLAN	This field displays the VLAN ID that is used for the Switch management purposes.
CPU Loading	This field displays the percentage of your Switch's system load.
Memory Information	This field displays the total memory the Switch has and the memory which is currently available (Free) and occupied (Usage).
Current Time	This field displays current date (yyyy-mm-dd) and time (hh:mm:ss).
DHCPv6 Client	This field displays whether the DHCPv6 client is enabled on the Switch.
IPv6 Local Address	This field displays the Switch's local IP address for IPv6.
IPv6 Default Gateway	This field displays the default gateway for IPv6.
IPv6 Global Address	This field displays the Switch's global IP address for IPv6.
Refresh	Click Refresh to begin configuring this screen afresh.

5. Basic Settings

5.1. General Settings

5.1.1. System

Management VLAN

To specify a VLAN group which can access the Switch.

- The valid VLAN range is from 1 to 4094.
- If you want to configure a management VLAN, the management VLAN should be created first and the management VLAN should have at least one member port.

Host Name

The **hostname** is same as the SNMP system name. Its length is up to 64 characters.

The first 16 characters of the hostname will be configured as the CLI prompt.

Notices:

The default Hostname is L2SWITCH

The default DHCP client is disabled.

The default Static IP is 192.168.0.254

Subnet Mask is 255.255.255.0

Default Gateway is 0.0.0.0

Management VLAN is 1.

5.1.1.1. CLI Configuration

Node	Command	Description
enable	show interface eth0	This command displays the eth0 configurations.
enable	configure terminal	This command changes the node to configure node.
configure	hostname STRINGS	This command sets the system's network name.
configure	interface eth0	This command enters the eth0 interface node to configure the system IP.
eth0	show	This command displays the eth0 configurations.
eth0	ip address A.B.C.D/M	This command configures a static IP and subnet mask for the system.
eth0	ip address default-gateway A.B.C.D	This command configures the system default gateway.
eth0	ip dhcp client (disable enable renew next_restart)	This command configures a DHCP client function for the system. disable: Use a static IP address on the switch. enable & renew: Use DHCP client to get an IP address from DHCP server. next_restart: The settings will take effect on next system restart.
eth0	management vlan <1-4094>	This command configures the management

		vlan.
eth0	ip ipv6-address AAAA:BBBB:CCCC:DDDD:E EEE:FFFF:GGGG:HHHH/M	This command configures a global scope of IPv6 address and subnet mask for the system.
eth0	ip ipv6-addressdefault-gateway AAAA:BBBB:CCCC:DDDD:E EEE:FFFF:GGGG:HHHH	This command configures a default gateway for the system.
eth0	ip ipv6-dhcp client (disable enable renew next_restart)	This command configures a DHCPv6 client function for the system. disable: Use a static IP address on the switch. enable & renew: Use DHCPv6 client to get an IP address from DHCPv6 server. next_restart: The settings will take effect on next system restart.

Example: The procedures to configure an IP address for the Switch.

- ✓ To enter the configure node.
L2SWITCH#configure terminal
L2SWITCH(config)#
- ✓ To enter the ETH0 interface node.
L2SWITCH(config)#interface eth0
L2SWITCH(config-if)#
- ✓ To get an IP address from a DHCP server.
L2SWITCH(config-if)#ip dhcp client enable
- ✓ To configure a static IP address and a gateway for the Switch.
L2SWITCH(config-if)#ip address 192.168.202.111/24
L2SWITCH(config-if)#ip address default-gateway 192.168.202.1
- ✓ To configure a static global IPv6 address and a gateway for the Switch.
 - Please set the static global IPv6 address first.
L2SWITCH(config-if)#ip ipv6-address 3ffe::1235/64
 - And the set the IPv6 default gateway address.
L2SWITCH(config-if)#ip ipv6-address default-gateway 3ffe::1234

5.1.1.2. Web Configuration

System Settings

System	Jumbo Frame	SNTP	Management Host
System Settings			
Hostname	<input type="text" value="L2SWITCH"/>		
Management VLAN	<input type="text" value="1"/>		
DHCP Server Port	<input type="text" value="1-12"/>		
IPv4 Settings			
DHCP Client	<input type="text" value="Enable"/> <input type="button" value="Renew"/>		
IP Address	<input type="text" value="192.168.202.171"/>		
Subnet Mask	<input type="text" value="255.255.255.0"/>		
Default Gateway	<input type="text" value="192.168.202.1"/>		
IPv6 Settings			
DHCPv6 Client	<input type="text" value="Disable"/> <input type="button" value="Renew"/>		
Global Address	<input type="text"/>		
Default Gateway	<input type="text" value="Set"/> <input type="text"/>		
<input type="button" value="Apply"/> <input type="button" value="Refresh"/>			

Parameter	Description
System Settings	
Hostname	Enter up to 64 alphanumeric characters for the name of your Switch. The hostname should be the combination of the digit or the alphabet or hyphens (-) or underscores (_).
Management VLAN	Enter a VLAN ID used for Switch management purposes.
DHCP Server Port	Configures a port or a range of ports for valid DHCP server.
IPv4 Settings	
IP Address	Configures a IPv4 address for your Switch in dotted decimal notation. For example, 192.168.0.254.
Subnet Mask	Enter the IP subnet mask of your Switch in dotted decimal notation for example 255.255.255.0.
Default Gateway	Enter the IP address of the default outgoing gateway in dotted decimal notation, for example 192.168.1.1.
IPv6 Settings	
DHCPv6 Client	Select Enable to allow the Switch to automatically get an IP address from a DHCPv6 server. Click Renew to have the Switch re-get an IP

	address from the DHCP server. Select Disable if you want to configure the Switch's IP address manually.
Global Address	Configure a global IPv6 address for the Switch.
Default Gateway	Set – Set an IPv6 default gateway for the Switch. Unset – Unset the IPv6 default gateway for the Switch.
Apply	Click Apply to take effect the settings.
Refresh	Click Refresh to begin configuring this screen afresh.

5.1.2. Jumbo Frame

Jumbo frames are Ethernet frames with a payload greater than 1500 bytes. Jumboframes can enhance data transmission efficiency in a network. The bigger the frame size, the better the performance.

Notice:

- ✓ The default jumbo frame is 10240 bytes.
- ✓ The jumbo frame settings will apply to all ports.
- ✓ If the size of a packet exceeds the jumbo frame size, the packet will be dropped.
- ✓ The available values are 1522, 1536, 1552, 9010, 9216,10240.

5.1.2.1. CLI Configuration

Node	Command	Description
enable	show jumboframe	This command displays the current jumbo frame settings.
enable	configure terminal	This command changes the node to configure node.
configure	interface IFNAME	This command enters the interface configure node.
interface	jumboframe(10240 1522 1536 1552 9010 9216)	This command configures the maximum number of bytes of frame size.
configure	interface range gigabitethernet1/0/PORTLISTS	This command enters the if-range configure node.
if-range	jumboframe(10240 1522 1536 1552 9010 9216)	This command configures the maximum number of bytes of frame size.

5.1.2.2. Web Configuration

System Settings

System
Jumbo Frame
SNTP
Management Host

Jumbo Frame Settings

Port	Frame Size
From: <input style="width: 30px;" type="text" value="1"/> To: <input style="width: 30px;" type="text" value="1"/>	<input style="width: 60px;" type="text" value="10240"/>
<input type="button" value="Apply"/> <input type="button" value="Refresh"/>	

Port	Jumbo Frame	Port	Jumbo Frame
1	10240	2	10240
3	10240	4	10240
5	10240	6	10240
7	10240	8	10240
9	10240	10	10240
11	10240	12	10240

Parameter	Description
Jumbo Frame Settings	
Port	This field specifies a port or a range of ports for configuration.
Frame Size	This field configures the maximum number of bytes of frame size for specified port(s). (available size:1522/1536/1552/9010/9216/10240)
Apply	Click Apply to take effect the settings.
Refresh	Click Refresh to begin configuring this screen afresh.

5.1.3. SNTP

The Network Time Protocol (NTP) is a protocol for synchronizing the clocks of computer systems over packet-switched, variable-latency data networks. A less complex implementation of NTP, using the same protocol but without requiring the storage of state over extended periods of time is known as the **Simple Network Time Protocol (SNTP)**. NTP provides Coordinated Universal Time (UTC). No information about time zones or daylight saving time is transmitted; this information is outside its scope and must be obtained separately.

UDP Port: 123.

Daylight saving is a period from late spring to early fall when many countries set their clocks ahead of normal local time by one hour to give more daytime light in the evening.

Note:

1. The SNTP server always replies the UTC current time.

2. When the Switch receives the SNTP reply time, the Switch will adjust the time with the time zone configuration and then configure the time to the Switch.
3. If the time server's IP address is not configured, the Switch will not send any SNTP request packets.
4. If no SNTP reply packets, the Switch will retry every 10 seconds forever.
5. If the Switch has received SNTP reply, the Switch will re-get the time from NTP server every 24 hours.
6. If the time zone and time NTP server have been changed, the Switch will repeat the query process.
7. No default SNTP server.

5.1.3.1. CLI Configuration

Node	Command	Description
enable	show time	This command displays current time and time configurations.
enable	configure terminal	This command changes the node to configure node.
configure	time HOUR:MINUTE:SECOND	Sets the current time on the Switch. <i>hour: 0-23</i> <i>min: 0-59</i> <i>sec: 0-59</i> Note: If you configure Daylight Saving Time after you configure the time, the Switch will apply Daylight Saving Time.
configure	time date YEAR/MONTH/DAY	Sets the current date on the Switch. <i>year: 1970-</i> <i>month: 1-12</i> <i>day: 1-31</i>
configure	time daylight-saving-time	This command enables the daylight saving time.
configure	no time daylight-saving-time	This command disables daylight saving on the Switch.
configure	time daylight-saving-time start-date (first second third fourth last)(S unday Monday Tuesday Wedne sday Thursday Friday Saturday) MONTH HOUR	This command sets the start time of the Daylight Saving Time.
configure	time daylight-saving-time end-date (first second third fourth last)(S unday Monday Tuesday Wedne sday Thursday Friday Saturday) MONTH HOUR	This command sets the end time of the Daylight Saving Time.
configure	time ntp-server (disable enable)	This command disables / enables the NTP

		server state.
configure	time ntp-server IP_ADDRESS	This command sets the IP address of your time server.
configure	time ntp-server domain-name STRING	This command sets a domain name of your time server.
configure	time timezone STRING	Configures the time difference between UTC (formerly known as GMT) and your time zone. Valid Range: -1200 ~ +1200.

Example:

```
L2SWITCH(config)#time ntp-server 192.5.41.41
L2SWITCH(config)#time timezone +0800
L2SWITCH(config)#time ntp-server enable
L2SWITCH(config)#time daylight-saving-time start-date first Monday 6 0
L2SWITCH(config)#time daylight-saving-time end-date last Saturday 10 0
```

5.1.3.2. Web Configuration

System Settings

System
Jumbo Frame
SNTP
Management Host

Current Time and Date

Current Time 00:01:09 (UTC+0)

Current Date 2020-01-01

Time and Date Settings

Manual

New Time . . / : : (yyyy.mm.dd / hh:mm:ss)

Enable Network Time Protocol

NTP Server ntp0.fau.de - Europe

Time Zone (+hh / -hh / +hhmm / -hhmm)

Daylight Saving Settings

State

Start Date of at o'clock

End Date of at o'clock

Parameter	Description
Current Time and Date	
Current Time	This field displays the time you open / refresh this menu.

Current Date	This field displays the date you open / refresh this menu.
Time and Date Setting	
Manual	Select this option if you want to enter the system date and time manually.
New Time	Enter the new date in year, month and day format and time in hour, minute and second format. The new date and time then appear in the Current Date and Current Time fields after you click Apply .
Enable Network Time Protocol	Select this option to use Network Time Protocol (NTP) for the time service.
NTP Server	Select a pre-designated time server or type the IP address or type the domain name of your timeserver. The Switch searches for the timeserver for up to 60 seconds.
Time Zone	Select the time difference between UTC (Universal Time Coordinated, formerly known as GMT, Greenwich Mean Time) and your time zone from the drop-down list box.
Daylight Saving Settings	
State	Select Enable if you want to use Daylight Saving Time. Otherwise, select Disable to turn it off.
Start Date	<p>Configure the day and time when Daylight Saving Time starts if you enabled Daylight Saving Time. The time is displayed in the 24 hour format. Here are a couple of examples:</p> <p>Daylight Saving Time starts in most parts of the United States on the second Sunday of March. Each time zone in the United States starts using Daylight Saving Time at 2 A.M. local time. So in the United States you would select Second, Sunday, March and 2:00.</p> <p>Daylight Saving Time starts in the European Union on the last Sunday of March. All of the time zones in the European Union start using Daylight Saving Time at the same moment (1 A.M. GMT or UTC). So in the European Union you would select Last, Sunday, March and the last field depends on your time zone. In Germany for instance, you would select 2:00 because Germany's time zone is one hour ahead of GMT or UTC (GMT+1).</p>
End Date	<p>Configure the day and time when Daylight Saving Time ends if you enabled Daylight Saving Time. The time field uses the 24 hour format.</p> <p>Here are a couple of examples:</p> <p>Daylight Saving Time ends in the United States on the last Sunday of October. Each time zone in the United States stops using Daylight Saving Time at 2 A.M. local time. So in the United States you would select First, Sunday, November and 2:00.</p> <p>Daylight Saving Time ends in the European Union on the last Sunday of October. All of the time zones in the European Union stop using Daylight Saving Time at the same moment (1 A.M. GMT or UTC).</p>

	So in the European Union you would select Last, Sunday, October and the last field depends on your time zone. In Germany for instance, you would select 2:00 because Germany's time zone is one hour ahead of GMT or UTC (GMT+1).
Apply	Click Apply to take effect the settings.
Refresh	Click Refresh to begin configuring this screen afresh.

5.1.4. Management Host

The feature limits the hosts which can manage the Switch. That is, any hosts can manage the Switch via **telnet** or **web browser**. If user has configured one or more management host, the Switch can be managed by these hosts only. The feature allow user to configure management IP based on particular IP or whole subnet.

Notices:

This feature allows user to configure management host up to 10 entries.
The default is none, any host can manage the Switch via telnet or web browser.

5.1.4.1. CLI Configuration

Node	Command	Description
enable	show interface eth0	This command displays the eth0 configurations.
enable	configure terminal	This command changes the node to configure node.
configure	interface eth0	This command enters the eth0 interface node to configure the system configurations.
eth0	management host	This command configures a static IP and subnet mask for the system.
eth0	show	The command displays the all of the interface eth0 configurations.
eth0	management host A.B.C.D	The command adds a management host address.
eth0	management subnet-host A.B.C.D/M	The command adds a management host address with a subnet mask.
eth0	no management host A.B.C.D	The command deletes a management host address.

Example:

```
L2SWITCH#configure terminal
L2SWITCH(config)#interface eth0
L2SWITCH(config-if)#management subnet-host 192.168.202.1/24
Success!
L2SWITCH(config-if)#management host 192.168.203.12
Success!
L2SWITCH(config-if)#management host 192.168.203.13
Success!
```

```
L2SWITCH(config-if)#show
DHCP Server port(s): 1-6
Eth0 DHCP client: Enable
DHCPv6 client: Disable
Management vlan: 1
Management Host: 192.168.202.1/24, 192.168.203.12/32, 192.168.203.13/32
Default gateway: 192.168.202.1
Link encap:Ethernet HWaddr 00:0B:04:90:60:21
inet addr:192.168.202.74 Bcast:192.168.202.255 Mask:255.255.255.0
inet6 addr: fe80::20b:4ff:fe90:6021/64 Scope:Link
UP BROADCAST RUNNING ALLMULTI MULTICAST MTU:1500
Metric:1 ASYMMTU:0
RX packets:17931 errors:0 dropped:6680 overruns:0 frame:0
TX packets:6500 errors:0 dropped:0 overruns:0 carrier:0
collisions:0 txqueuelen:500
RX bytes:3565872 (3.4 Mb) TX bytes:1173040 (1.1 Mb)
```

5.1.4.2. Web Configuration

System Settings

System	Jumbo Frame	SNTP	Management Host
Management Host Settings			
Management Host:	<input type="text"/>	Subnet Mask:	<input type="text"/>
<input type="button" value="Apply"/>		<input type="button" value="Refresh"/>	
Management Host List			
No.	Management Host (IP/Mask)	Action	

Parameter	Description
Management Host Settings	
Management Host	This field configures the management host.
Subnet Mask	This field configures the subnet, so that any host in that subnet can control the switch
Apply	Click Apply to take effect the settings.
Refresh	Click Refresh to begin configuring this screen afresh.
Management Host List	
No.	This field displays a sequential number for each management host.
Management Host	This field displays the management host and the number of mask bit.

(IP/Mask)	
Action	Click Delete to remove the specified entry.

5.2. MAC Management

Dynamic Address:

The MAC addresses are learnt by the switch. When the switch receives frames, it will record the source MAC, the received port and the VLAN in the address table with an age time. When the age time is expired, the address entry will be removed from the address table.

Static Address:

The MAC addresses are configured by users. The static addresses will not be aged out by the switch; it can be removed by user only. The maximum static address entry is up to 256.

The **MAC Table** (a MAC table is also known as a filtering database) shows how frames are forwarded or filtered across the Switch's ports. When a device (which may belong to a VLAN group) sends a packet which is forwarded to a port on the Switch, the MAC address of the device is shown on the Switch's MAC Table. It also shows whether the MAC address is dynamic (learned by the Switch) or static (manually entered).

The Switch uses the **MAC Table** to determine how to forward frames. See the following figure.

1. The Switch examines the received frame and learns the port from which this source MAC address came.
2. The Switch checks to see if the frame's destination MAC address matches a source MAC address already learnt in the **MAC Table**.
 - If the Switch has already learnt the port for this MAC address, then it forwards the frame to that port.
 - If the Switch has not already learnt the port for this MAC address, then the frame is flooded to all ports. If too much port flooding, it may lead to network congestion.
 - If the Switch has already learnt the port for this MAC address, but the destination port is the same as the port it came in on, then it filters the frame.

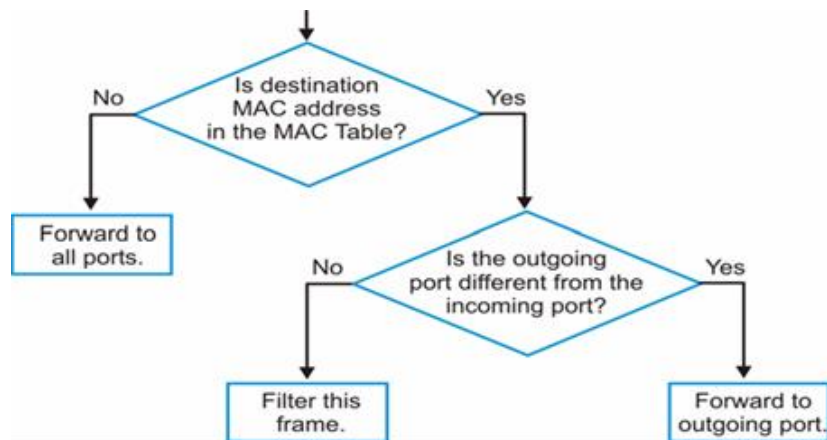

Figure MAC Table Flowchart

Notices:

The default MAC address table age time is 300 seconds.
 The Maximum static address entry is 256.

5.2.1. Static MAC

5.2.1.1. CLI Configuration

Node	Command	Description
enable	show mac-address-table (static dynamic)	This command displays the current static/dynamic unicast address entries.
enable	configure terminal	This command changes the node to configure node.
configure	mac-address-table static MACADDR vlan <1-4094> port PORT_ID	This command configures a static unicast entry.
configure	no mac-address-table static MACADDR vlan <1-4094>	This command removes a static unicast entry from the address table.

Example:

L2SWITCH(config)#mac-address-table static 00:11:22:33:44:55 vlan 1 port 1

5.2.1.2. Web Configuration

A static Media Access Control (MAC) address is an address that has been manually entered in the MAC address table, and do not age out. When you set up static MAC address rules, you are setting static MAC addresses for a port, so this may reduce the need for broadcasting.

MAC Management

Static MAC
MAC Table
Age Time
Refusal MAC

Static MAC Settings

MAC Address	VLAN ID	Port
<input type="text"/>	<input type="text"/>	1 ▾

Static MAC Table

MAC Address	VLAN ID	Port	Action
90:f0:52:68:0c:68	1	CPU	

Total Counts: 1

Parameter	Description
-----------	-------------

Static MAC Settings	
MAC Address	Enter the MAC address of a computer or device that you want to add to the MAC address table. Valid format is hh:hh:hh:hh:hh:hh.
VLAN ID	Enter the VLAN ID to apply to the computer or device.
Port	Enter the port number to which the computer or device is connected.
Apply	Click Apply to take effect the settings.
Refresh	Click Refresh to begin configuring this screen afresh.
Static MAC Table	
MAC Address	This field displays the MAC address of a manually entered MAC address entry.
VLAN ID	This field displays the VID of a manually entered MAC address entry.
Port	This field displays the port number of a manually entered MAC address entry. The MAC address with port CPU means the Switch's MAC addresses itself.
Action	Click Delete to remove this manually entered MAC address entry from the MAC address table. You cannot delete the Switch's MAC address from the static MAC address table.

5.2.2. MAC Table

5.2.2.1. CLI Configuration

Node	Command	Description
enable	show mac-address-table(static dynamic)	This command displays the current static/dynamic unicast address entries.
enable	show mac-address-table mac MACADDR	This command displays information of a specific MAC.
enable	show mac-address-table port PORT_ID	This command displays the current unicast address entries learnt by the specific port.
enable	configure terminal	This command changes the node to configure node.
configure	clear mac address-table dynamic	This command clears the dynamic address entries.

5.2.2.2. Web Configuration

MAC Management

Static MAC
MAC Table
Age Time
Refusal MAC

MAC Table

Show Type All Apply Refresh Clear

MAC Address	Type	VLAN ID	Port/Trunk ID
00:0b:04:08:02:e6	Dynamic	1	8
00:0b:04:14:7a:75	Dynamic	1	8
00:0b:04:28:2c:aa	Dynamic	1	8
00:17:c5:66:48:cc	Dynamic	1	8
00:68:eb:aa:3d:cd	Dynamic	1	8
18:31:bf:92:d4:a2	Dynamic	1	8
54:a0:50:87:f3:3d	Dynamic	1	8
90:f0:52:68:0c:68	Static	1	CPU
a0:8c:fd:ec:12:f8	Dynamic	1	8

Total Counts: **9**

Page UP
Page Down
Page: 1/1
Page: 1 Apply

Parameter	Description
Mac Table	
Show Type Apply	Select All , Static , Dynamic or Port and then click Apply to display the corresponding MAC address entries on this screen.
Refresh	Click Refresh to begin configuring this screen afresh.
MAC Address	This field displays a MAC address.
Type	This field displays whether this entry was entered manually (Static) or whether it was learned by the Switch (Dynamic).
VLAN ID	This field displays the VLAN ID of the MAC address entry.
Port / Trunk ID	This field displays the port number / Trunk ID the MAC address entry is associated. It displays CPU if it is the entry for the Switch itself. The CPU means that it is the Switch's MAC.
Total Counts	This field displays the total entries in the MAC table.

5.2.3. Age Time Settings

5.2.3.1. CLI Configuration

Node	Command	Description
------	---------	-------------

enable	show mac-address-table aging-time	This command displays the current MAC address table age time.
enable	configure terminal	This command changes the node to configure mode.
configure	mac-address-table aging-time VALUE	This command configures the mac table aging time. The range is 20 to 400 or 0: disable.

Example:

```
L2SWITCH(config)#mac-address-table aging-time 200
Success!
```

```
L2SWITCH#show mac-address-table aging-time
The mac-address-table aging-time is 200 sec.
```

5.2.3.2. Web Configuration

MAC Management

Static MAC
MAC Table
Age Time
Refusal MAC

Age Time Settings

Age Time (sec) (Range: 20-400 or 0:disable)

Parameter	Description
Age Time Setting	
Age Time	Configure the age time; the valid range is from 20 to 400 seconds. The default value is 300 seconds. 0 means that the system will not age out any entries.
Apply	Click Apply to take effect the settings.
Refresh	Click Refresh to begin configuring this screen afresh.

5.2.4. Refusal

This type of MAC address entries are configured manually. A switch discards the packets destined for or originated from the MAC addresses contained in refusal MAC address entries. Refusal entries are configured for filtering out frames with specific source or destination MAC addresses

Notice: User can configure up to 20 entries.

5.2.4.1. CLI Configuration

Node	Command	Description
enable	show mac-address-table refusal	This command displays the current refusal MAC address only.
enable	configure terminal	This command changes the node to configure node.
configure	mac-address-table refusal MACADDR vlan <1-4094>	This command configures a refusal MAC on a specific VLAN.
configure	mac-address-table refusal MACADDR	This command configures a refusal MAC.

Example: The procedures to configure a refusal MAC address

- ✓ To enter the configure node.
L2SWITCH#configure terminal
L2SWITCH(config)#
- ✓ To configure a refusal MAC address for all ports and all vlans.
L2SWITCH(config)#mac-address-table refusal 00:11:22:33:44:55
- ✓ To configure a refusal MAC address for all ports on a specific vlan.
L2SWITCH(config)#mac-address-table refusal 00:11:22:33:44:55 vlan 1.

5.2.4.2. Web Configuration

MAC Management

Static MAC
MAC Table
Age Time
Refusal MAC

Refusal MAC Settings

MAC Address

VLAN ID

Any ▾

Refusal MAC Table

MAC Address	VLAN ID	Action

Total Counts: 0

Parameter	Description
Refusal MAC Settings	
MAC Address	Enter the MAC address of a computer or device that you want to refusal. Valid format is hh:hh:hh:hh:hh:hh.
VLAN ID	Enter the VLAN ID to apply to the computer or device.
Apply	Click Apply to take effect the settings.
Refresh	Click Refresh to begin configuring this screen afresh.
Refusal MAC Table	
Action	Click Delete to remove this manually entered MAC address entry from the refusal MAC address table.
Total Counts	This field displays the total entries in the refusal MAC table.

5.3. Port Mirror

Port-based Mirroring

The Port-Based Mirroring is used on a network switch to send a copy of network packets sent/received on one or a range of switch ports to a network monitoring connection on another switch port (**Monitor to Port**). This is commonly used for network appliances that require monitoring of network traffic, such as an intrusion-detection system.

Port Mirroring, together with a network traffic analyzer, helps to monitor network traffic. Users can monitor the selected ports (**Source Ports**) for egress and/or ingress packets.

Source Mode:

- Ingress : The received packets will be copied to the monitor port.
- Egress : The transmitted packets will be copied to the monitor port.
- Both : The received and transmitted packets will be copied to the monitor port.

Notices:

1. The monitor port cannot be a trunk member port.
2. The monitor port cannot be ingress or egress port.
3. If the Port Mirror function is enabled, the Monitor-to Port can receive mirrored packets only.
4. If a port has been configured as a source port and then user configures the port as a destination port, the port will be removed from the source ports automatically.

5.3.1. CLI Configuration

Node	Command	Description
enable	show mirror	This command displays the current port mirroring configurations.
enable	configure terminal	This command changes the node to configure node.
configure	mirror (disable enable)	This command disables / enables the port mirroring on the switch.
configure	mirror destination port PORT_ID	This command specifies the monitor port for the port mirroring.
configure	mirror source ports PORT_LIST mode (both ingress egress)	This command adds a port or a range of ports as the source ports of the port mirroring.
configure	no mirror source ports PORT_LIST	This command removes a port or a range of ports from the source ports of the port mirroring.

Example:

```
L2SWITCH#configure terminal
L2SWITCH(config)#mirror destination port 9
Success!
L2SWITCH(config)#mirror source ports 1-8 mode ingress
Success!
```

```
L2SWITCH(config)#exit
L2SWITCH#show mirror
Mirror Configurations:
State           : Disabled.
Monitor port    : 9.
Ingress port(s): 1-8.
Egress port(s) : None.
```

5.3.2. Web Configuration

Port Mirror

Port Mirroring Settings

State

Monitor to Port

All Ports :

Source Port	Mirror Mode	Source Port	Mirror Mode
1	<input type="text" value="Disable"/>	2	<input type="text" value="Disable"/>
3	<input type="text" value="Disable"/>	4	<input type="text" value="Disable"/>
5	<input type="text" value="Disable"/>	6	<input type="text" value="Disable"/>
7	<input type="text" value="Disable"/>	8	<input type="text" value="Disable"/>
9	<input type="text" value="Disable"/>	10	<input type="text" value="Disable"/>
11	<input type="text" value="Disable"/>	12	<input type="text" value="Disable"/>

Parameter	Description
Port Mirroring Settings	
State	Select Enable to turn on port mirroring or select Disable to turn it off.
Monitor to Port	Select the port which connects to a network traffic analyzer.
All Ports	Settings in this field apply to all ports. Use this field only if you want to make some settings the same for all ports. Use this field first to set the common settings and then make adjustments on a port-by-port basis.
Source Port	This field displays the number of a port.
Mirror Mode	Select Ingress , Egress or Both to only copy the ingress (incoming), egress (outgoing) or both (incoming and outgoing) traffic from the specified source ports to the monitor port. Select Disable to not copy any traffic from the specified source ports to the monitor port.

Apply	Click Apply to take effect the settings.
Refresh	Click Refresh to begin configuring this screen afresh.

5.4 RSPAN

Remote Switch Port Analyzer (RSPAN) is a network monitoring feature that allows for the mirroring of traffic from one switch port to another switch port across different switches. This capability is particularly useful for network administrators who need to analyze traffic from multiple locations without being physically present at each switch.

RSPAN is a valuable tool for network management, providing flexibility in monitoring and analyzing network traffic across a distributed environment.

5.4.1 CLI Command

Node	Command	Description
enable	show rspan	This command displays the current rspan configurations.
enable	configure terminal	This command changes the node to configure node.
configure	rspan (disable enable)	This command disables / enables the rspan on the switch.
configure	rspan destination port PORT_ID	This command specifies the monitor port for the rspan.
configure	rspan source ports PORT_LIST mode (<i>both ingress egress</i>)	This command adds a port or a range of ports as the source ports of the rspan.
configure	no rspan source ports PORT_LIST	This command removes a port or a range of ports from the source ports of the port mirroring.
configure	rspan vlan <1-4094>	This command create a VLAN that will be used as the RSPAN VLAN on both switches..
configure	rspan role (destination intermediate source)	This command configures the role (destination intermediate source) for the Switch.

5.4.2 CLI Command Example

```
L2SWITCH(config-if-range)# pvid 20
L2SWITCH(config)#rspan role source
L2SWITCH(config)#rspan source ports 2 mode both
L2SWITCH(config)#rspan destination port 1
L2SWITCH(config)#rspan vlan 20
L2SWITCH(config)#rspan enable
```

5.4.3 Web configuration

RSPAN

RSPAN Settings

State

Role

Monitor to Port

Vlan

All Ports :

Source Port	Mirror Mode	Source Port	Mirror Mode
1	<input type="text" value="Disable"/>	2	<input type="text" value="Disable"/>
3	<input type="text" value="Disable"/>	4	<input type="text" value="Disable"/>
5	<input type="text" value="Disable"/>	6	<input type="text" value="Disable"/>
7	<input type="text" value="Disable"/>	8	<input type="text" value="Disable"/>
9	<input type="text" value="Disable"/>	10	<input type="text" value="Disable"/>
11	<input type="text" value="Disable"/>	12	<input type="text" value="Disable"/>

Parameter	Description
Port Mirroring Settings	
State	Select Enable to turn on RSPAN or select Disable to turn it off.
Role	Selects one of the three roles, destination and intermediate and source , for the specific ports.
Monitor to Port	Select the port which connects to a network traffic analyzer.
Vlan	This VLAN will carry the RSPAN traffic in a vlan.
Mirror Mode	Select Ingress , Egress or Both to only copy the ingress (incoming), egress (outgoing) or both (incoming and outgoing) traffic from the specified source ports to the monitor port. Select Disable to not copy any traffic from the specified source ports to the monitor port.
Apply	Click Apply to take effect the settings.
Refresh	Click Refresh to begin configuring this screen afresh.

5.5 Port Settings

- Duplex mode

A *duplex* communication system is a system composed of two connected parties or devices that can communicate with one another in both directions.

Half Duplex:

A *half-duplex* system provides for communication in both directions, but only one direction at a time (not simultaneously). Typically, once a party begins receiving a signal, it must wait for the transmitter to stop transmitting, before replying.

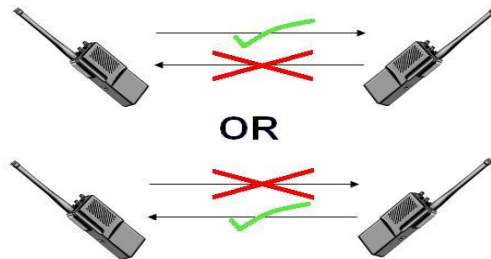

Full Duplex:

A *full-duplex*, or sometimes *double-duplex* system, allows communication in both directions, and, unlike half-duplex, allows this to happen simultaneously. Land-line telephone networks are full-duplex, since they allow both callers to speak and be heard at the same time.

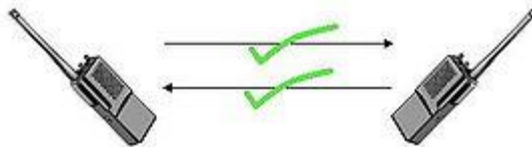

- Loopback Test

A loopback test is a test in which a signal is sent from a communications device and returned (looped back) to it as a way to determine whether the device is working right or as a way to pin down a failing node in a network. One type of loopback test is performed using a special plug, called a **wrap plug** that is inserted in a port on a communications device. The effect of a wrap plug is to cause transmitted (output) data to be returned as received (input) data, simulating a complete communications circuit using a single computer.

- Auto MDI-MDIX

Auto-MDIX (automatic medium-dependent interface crossover) is a computer networking technology that automatically detects the required cable connection type (straight-through or crossover) and configures the connection appropriately, thereby removing the need for crossover cables to interconnect switches or connecting PCs peer-to-peer. When it is enabled, either type of cable can be used or the interface automatically corrects any incorrect cabling. For Auto-MDIX to operate correctly, the speed on the interface and duplex setting must be set to "auto". Auto-MDIX was developed by HP engineers Dan Dove and Bruce Melvin.

- Auto Negotiation

Auto (auto-negotiation) allows one port to negotiate with a peer port automatically to obtain the connection speed and duplex mode that both ends support. When auto-negotiation is turned on,

a port on the Switch negotiates with the peer automatically to determine the connection speed and duplex mode.

If the peer port does not support auto-negotiation or turns off this feature, the Switch determines the connection speed by detecting the signal on the cable and using **half-duplex** mode. When the Switch's auto-negotiation is turned off, a port uses the pre-configured speed and duplex mode when making a connection, thus requiring you to make sure that the settings of the peer port are the same in order to connect.

- **Flow Control**

A concentration of traffic on a port decreases port bandwidth and overflows buffer memory causing packet discards and frame losses. IEEE802.3x flow control is used in full duplex mode to send a pause signal to the sending port, causing it to temporarily stop sending signals when the receiving port memory buffers fill and resend later.

The Switch uses IEEE802.3x flow control in full duplex mode and backpressure flow control in half duplex mode. IEEE802.3x flow control is used in full duplex mode to send a pause signal to the sending port, causing it to temporarily stop sending signals when the receiving port memory buffers fill. Back Pressure flow control is typically used in half duplex mode to send a "collision" signal to the sending port (mimicking a state of packet collision) causing the sending port to temporarily stop sending signals and resend later.

Note: 1000 Base-T doesn't support force mode.

Notices:

The default port Speed & Duplex is auto for all ports.

The default port Flow Control is Off for all ports.

5.5.1 General Settings

5.5.1.1 CLI Configuration

Node	Command	Description
enable	show interface IFNAME	This command displays the current port configurations.
enable	configure terminal	This command changes the node to configure node.
configure	interface IFNAME	This command enters the interface configure node.
interface	show	This command displays the current port configurations.
interface	loopback (none mac)	This command tests the loopback mode of operation for the specific port.
interface	flowcontrol (off on)	This command disables / enables the flow control for the port.
interface	speed (auto 10-full 10-half 100-full 100-half 1000-full)	This command configures the speed and duplex for the port.
interface	shutdown	This command disables the specific port.

interface	no shutdown	This command enables the specific port.
configure	interface range gigabitethernet1/0/PORTLISTS	This command enters the if-range configure node.
if-range	shutdown	This command disables the specific ports.
if-range	no shutdown	This command enables the specific ports.
if-range	speed (auto 10-full 10-half 100-full 100-half 1000-full)	This command configures the speed and duplex for the port.

Example:

```
L2SWITCH#configure terminal  
L2SWITCH(config)#interface gi1/0/1  
L2SWITCH(config-if)#speed auto
```

5.5.1.2 Web Configuration

Port Settings

General Settings
Information

Port Settings

Port	State	Speed/Duplex	Flow Control
From: <input type="text" value="1"/> To: <input type="text" value="1"/>	<input type="text" value="Enable"/>	<input type="text" value="Auto"/>	<input type="text" value="On"/>

Port Status

Port	State	Speed/Duplex	Flow Control	Link Status
1	Enabled	Auto	On	Link Down
2	Enabled	Auto	On	Link Down
3	Enabled	Auto	On	Link Down
4	Enabled	Auto	On	Link Down
5	Enabled	Auto	On	Link Down
6	Enabled	Auto	On	Link Down
7	Enabled	Auto	On	Link Down
8	Enabled	Auto	On	1000M / Full / On
9	Enabled	Auto	On	Link Down
10	Enabled	Auto	On	Link Down
11	Enabled	Auto	On	Link Down
12	Enabled	Auto	On	Link Down

Parameter	Description
Port Settings	
Port	Select a port or a range ports you want to configure on this screen.
State	Select Enable to activate the port or Disable to deactivate the port.
Speed/Duplex	Select the speed and duplex mode of the port. The choices are: <ul style="list-style-type: none"> • Auto • 10 Mbps / Full Duplex • 10 Mbps / Half Duplex • 100 Mbps / Full Duplex • 100 Mbps / Half Duplex • 1000 Mbps / Full Duplex
Flow Control	Select On to enable access to buffering resources for the port thus ensuring lossless operation across network switches. Otherwise, select Off to disable it.
Apply	Click Apply to take effect the settings.

Refresh	Click Refresh to begin configuring this screen afresh.
Port Status	
Port	This field displays the port number.
State	This field displays whether the port is enabled or disabled.
Speed/Duplex	This field displays the speed either 10M , 100M or 1000M and the duplex mode Full or Half .
Flow Control	This field displays whether the port's flow control is On or Off .
Link Status	This field displays the link status of the port. If the port is up, it displays the port's speed, duplex and flow control setting. Otherwise, it displays Link Down if the port is disabled or not connected to any device.

5.5.2 Information

5.5.2.1 CLI Configuration

Node	Command	Description
enable	show interface IFNAME	This command displays the current port configurations.
enable	configure terminal	This command changes the node to configure node.
configure	interface IFNAME	This command enters the interface configure node.
interface	show	This command displays the current port configurations.
interface	description STRING	This command configures a description for the specific port. The length of description is up to 240 characters.
interface	no description	This command configures the default port description.
interface	alias STRING	This command configures an alias for the specific port. The length of alias is up to 64 characters.
interface	no alias	This command reset the alias to default.
configure	interface range gigabitethernet1/0/PORTLISTS	This command enters the if-range configure node.
if-range	description STRINGs	This command configures a description for the specific ports.
if-range	no description	This command configures the default port description for the specific ports.
if-range	alias STRING	This command configures an alias for the specific ports. The length of alias is up to 64 characters.
if-range	no alias	This command reset the alias to default.

5.5.2.2 Web Configuration

Port Settings

General Settings
Information

Port Settings

Port	Description	Alias
From: <input type="text" value="1"/> <input type="text" value="To: 1"/>	<input type="text" value="gigabitethernet1/0/1"/>	<input type="text" value="gigabitethernet1/0/1"/>

Port Status

Port	Description	Alias	Status	Uptime	Medium Mode
1	gigabitethernet1/0/1	gigabitethernet1/0/1	Normally	0 days 0:0:0	Copper
2	gigabitethernet1/0/2	gigabitethernet1/0/2	Normally	0 days 0:0:0	Copper
3	gigabitethernet1/0/3	gigabitethernet1/0/3	Normally	0 days 0:0:0	Copper
4	gigabitethernet1/0/4	gigabitethernet1/0/4	Normally	0 days 0:0:0	Copper
5	gigabitethernet1/0/5	gigabitethernet1/0/5	Normally	0 days 0:0:0	Copper
6	gigabitethernet1/0/6	gigabitethernet1/0/6	Normally	0 days 0:0:0	Copper
7	gigabitethernet1/0/7	gigabitethernet1/0/7	Normally	0 days 0:0:0	Copper
8	gigabitethernet1/0/8	gigabitethernet1/0/8	Normally	0 days 0:0:49	Copper
9	gigabitethernet1/0/9	gigabitethernet1/0/9	Normally	0 days 0:0:0	Fiber
10	gigabitethernet1/0/10	gigabitethernet1/0/10	Normally	0 days 0:0:0	Fiber
11	gigabitethernet1/0/11	gigabitethernet1/0/11	Normally	0 days 0:0:0	Fiber
12	gigabitethernet1/0/12	gigabitethernet1/0/12	Normally	0 days 0:0:0	Fiber

Parameter	Description
Port Settings	
Port	Select a port or a range ports you want to configure on this screen.
Description	Configures a meaningful name for the port(s).
Alias	Configures an alias for the port(s).
Apply	Click Apply to take effect the settings.
Refresh	Click Refresh to begin configuring this screen afresh.
Port Status	
Port	This field displays the port number.
Description	The meaningful name for the port.
Alias	The alias name for the port.
Status	The field displays the detail port status if the port is blocked by some protocol.

Uptime	The sustained time from last link up.
Medium Mode	The current working medium mode, copper or fiber, for the port.

6 Advanced Settings

6.4 Bandwidth Control

6.4.1 QoS

Each egress port can support up to 8 transmit queues. Each egress transmit queue contains a list specifying the packet transmission order. Every incoming frame is forwarded to one of the 8 egress transmit queues of the assigned egress port, based on its priority. The egress port transmits packets from each of the 8 transmit queues according to a configurable scheduling algorithm, which can be a combination of Strict Priority (SP) and/or Weighted Round Robin (WRR).

Typically, networks operate on a best-effort delivery basis, which means that all traffic has equal priority and an equal chance of being delivered in a timely manner. When congestion occurs, all traffic has an equal chance of being dropped.

When you configure the QoS feature, you can select specific network traffic, prioritize it according to its relative importance, and use congestion-management and congestion-avoidance techniques to give preferential treatment. Implementing QoS in your network makes network performance more predictable and bandwidth utilization more effective.

The Switch supports 802.1p priority queuing. The Switch has 8 priority queues. These priority queues are numbered from 7 (Class 7) — the highest priority queue — to 0 (Class 0) — the lowest priority queue.

The eight priority tags specified in IEEE 802.1p (p0 to p7) are mapped to the Switch's priority queues as follows:

Priority	: 0	1	2	3	4	5	6	7
Queue	: 2	0	1	3	4	5	6	7

Priority scheduling is implemented by the priority queues stated above. The Switch will empty the four hardware priority queues in order, beginning with the highest priority queue, 7, to the lowest priority queue, 0. Each hardware queue will transmit all of the packets in its buffer before permitting the next lower priority to transmit its packets. When the lowest hardware priority queue has finished transmitting all of its packets, the highest hardware priority queue will begin transmitting any packets it may have received.

QoS Enhancement

You can configure the Switch to prioritize traffic even if the incoming packets are not marked with IEEE 802.1p priority tags or change the existing priority tags based on the criteria you select. The Switch allows you to choose one of the following methods for assigning priority to incoming packets on the Switch:

- **802.1p Tag Priority** - Assign priority to packets based on the packet's 802.1p tagged priority.
- **Port Based QoS** - Assign priority to packets based on the incoming port on the Switch.
- **DSCP Based QoS** - Assign priority to packets based on their Differentiated Services

Code Points (DSCPs).

Note: Advanced QoS methods only affect the internal priority queue mapping for the Switch. The Switch does not modify the IEEE 802.1p value for the egress frames. You can choose one of these ways to alter the way incoming packets are prioritized or you can choose not to use any QoS enhancement setting on the Switch.

802.1p Priority

When using 802.1p priority mechanism, the packet is examined for the presence of a valid 802.1p priority tag. If the tag is present, the packet is assigned to a programmable egress queue based on the value of the tagged priority. The tagged priority can be designated to any of the available queues.

Ethernet Packet:

6	6	2	42-1496	4
DA	SA	Type / Length	Data	FCS

6	6	4	2	42-1496	4
DA	SA	802.1Q Tag	Type / Length	Data	FCS

802.1Q Tag:

2 bytes		2 bytes		
Tag Protocol Identifier (TPID)		Tag Control Information (TCI)		
16 bits		3 bits	1 bit	12 bits
TPID (0x8100)		Priority	CFI	VID

- Tag Protocol Identifier (TPID): a 16-bit field set to a value of **0x8100** in order to identify the frame as an IEEE 802.1Q-tagged frame.
- Tag Control Information (TCI)
 - Priority Code Point (PCP): a 3-bit field which refers to the IEEE 802.1p priority. It indicates the frame priority level from **0 (lowest) to 7 (highest)**, which can be used to prioritize different classes of traffic (voice, video, data, etc.).
 - Canonical Format Indicator (CFI): a 1-bit field. If the value of this field is 1, the MAC address is in non-canonical format. If the value is 0, the MAC address is in canonical format. It is always set to zero for Ethernet switches. CFI is used for compatibility between Ethernet and Token Ring networks. If a frame received at an Ethernet port has a CFI set to 1, then that frame should not be bridged to an untagged port.
 - VLAN Identifier (VID): a 12-bit field specifying the VLAN to which the frame belongs. A value of 0 means that the frame doesn't belong to any VLAN; in this case the 802.1Q tag specifies only a priority and is referred to as a **priority tag**. A value of hex 0xFFF is reserved for implementation use. All other values may be used as VLAN identifiers, allowing up to 4094 VLANs. On bridges, VLAN 1 is often reserved for management.

Priority Levels

PCP: Priority Code Point.

PCP	Network Priority	Traffic Characteristics
1	0 (lowest)	Background
0	1	Best Effort
2	2	Excellent Effort
3	3	Critical Applications
4	4	Video, <100ms latency
5	5	Video, < 10ms latency
6	6	Internetwork Control
7	7 (highest)	Network Control

6.4.1.1 Port Priority

6.4.1.1.1 CLI Configuration

Node	Command	Description
enable	show interface IFNAME	This command displays the current port configurations.
enable	configure terminal	This command changes the node to configure node.
configure	interface IFNAME	This command enters the interface configure node.
interface	default-priority <0-7>	This command allows the user to specify a default priority handling of untagged packets received by the Switch. The priority value entered with this command will be used to determine which of the hardware priority queues the packet is forwarded to. Default: 0.
interface	no default-priority	This command configures the default priority (0) for the specific port.

6.4.1.1.2 Web Configuration

QoS

Port Priority
IP DiffServ (DSCP)
Priority/Queue Mapping
Schedule Mode

Port Priority Settings

All Ports 802.1p Priority : -

Port	802.1p Priority	Port	802.1p Priority
1	0 ▾	2	0 ▾
3	0 ▾	4	0 ▾
5	0 ▾	6	0 ▾
7	0 ▾	8	0 ▾
9	0 ▾	10	0 ▾
11	0 ▾	12	0 ▾

Apply
Refresh

Parameter	Description
Port Priority Settings	
All Ports 802.1p priority	Use this field to set a priority for all ports. The value indicates packet priority and is added to the priority tag field of incoming packets. The values range from 0 (lowest priority) to 7 (highest priority).
Port	This field displays the number of a port.

802.1p Priority	Select a priority for packets received by the port. Only packets without 802.1p priority tagged will be applied the priority you set here.
Apply	Click Apply to take effect the settings.
Refresh	Click Refresh to begin configuring this screen afresh.

6.4.1.2 IP DiffServ (DSCP)

DiffServ (DSCP)

Differentiated Services or **DiffServ** is a computer networking architecture that specifies a simple, scalable and coarse-grained mechanism for classifying, managing network traffic and providing Quality of Service (**QoS**) guarantees on modern IP networks. DiffServ can, for example, be used to provide low-latency, guaranteed service (**GS**) to critical network traffic such as voice or video while providing simple best-effort traffic guarantees to non-critical services such as web traffic or file transfers.

Differentiated Services Code Point (DSCP) is a 6-bit field in the header of IP packets for packet classification purposes. DSCP replaces the outdated IP precedence, a 3-bit field in the Type of Service byte of the IP header originally used to classify and prioritize types of traffic.

When using the DiffServ priority mechanism, the packet is classified based on the DSCP field in the IP header. If the tag is present, the packet is assigned to a programmable egress queue based on the value of the tagged priority. The tagged priority can be designated to any of the available queues.

Version	IHL	Type of Service	Total Length	
Identification			Flags	Fragment Offset
Time to Live	Protocol		Header Checksum	
Source Address				
Destination Address				
Options				Padding

Example Internet Datagram Header

IP Header Type of Service: 8 bits

The Type of Service provides an indication of the abstract parameters of the quality of service desired. These parameters are to be used to guide the selection of the actual service parameters when transmitting a datagram through a particular network. Several networks offer service precedence, which somehow treats high precedence traffic as more important than other traffic (generally by accepting only traffic above certain precedence at time of high load). The major choice is a three way tradeoff between low-delay, high-reliability, and high-throughput.

Bits 0-2: Precedence.

Bit 3: 0 = Normal Delay, 1 = Low Delay.

Bits 4: 0 = Normal Throughput, 1 = High Throughput.

Bits 5: 0 = Normal Reliability, 1 = High Reliability.

Bit 6-7: Reserved for Future Use.

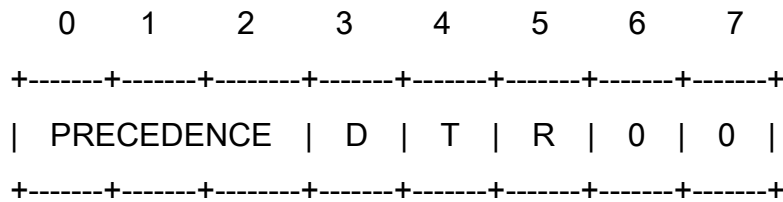

Precedence

- 111 - Network Control
- 110 - Internetwork Control
- 101 - CRITIC/ECP
- 100 - Flash Override
- 011 - Flash
- 010 - Immediate
- 001 - Priority
- 000 - Routine

The use of the Delay, Throughput, and Reliability indications may increase the cost (in some sense) of the service. In many networks better performance for one of these parameters is coupled with worse performance on another. Except for very unusual cases at most two of these three indications should be set.

The type of service is used to specify the treatment of the datagram during its transmission through the internet system. Example mappings of the internet type of service to the actual service provided on networks such as AUTODIN II, ARPANET, SATNET, and PRNET is given in "Service Mappings".

The Network Control precedence designation is intended to be used within a network only. The actual use and control of that designation is up to each network. The Internetwork Control designation is intended for use by gateway control originators only.

If the actual use of these precedence designations is of concern to a particular network, it is the responsibility of that network to control the access to, and use of, those precedence designations.

6.4.1.2.1 CLI Configuration

Node	Command	Description
enable	show diffserv	This command displays DiffServ configurations.
enable	configure terminal	This command changes the node to configure mode.
configure	diffserv (disable enable)	This command disables / enables the DiffServ function.
configure	diffserv dscp <0-63> priority <0-7>	This command sets the DSCP-to-IEEE 802.1q mappings.

6.4.1.2.2 Web Configuration

QoS

Port Priority
IP DiffServ (DSCP)
Priority/Queue Mapping
Schedule Mode

DSCP Settings

Mode Tag Over DSCP ▼

DSCP	Priority	DSCP	Priority	DSCP	Priority	DSCP	Priority
DSCP 0	0 ▼	DSCP 1	0 ▼	DSCP 2	0 ▼	DSCP 3	0 ▼
DSCP 4	0 ▼	DSCP 5	0 ▼	DSCP 6	0 ▼	DSCP 7	0 ▼
DSCP 8	0 ▼	DSCP 9	0 ▼	DSCP 10	0 ▼	DSCP 11	0 ▼
DSCP 12	0 ▼	DSCP 13	0 ▼	DSCP 14	0 ▼	DSCP 15	0 ▼
DSCP 16	0 ▼	DSCP 17	0 ▼	DSCP 18	0 ▼	DSCP 19	0 ▼
DSCP 20	0 ▼	DSCP 21	0 ▼	DSCP 22	0 ▼	DSCP 23	0 ▼
DSCP 24	0 ▼	DSCP 25	0 ▼	DSCP 26	0 ▼	DSCP 27	0 ▼
DSCP 28	0 ▼	DSCP 29	0 ▼	DSCP 30	0 ▼	DSCP 31	0 ▼
DSCP 32	0 ▼	DSCP 33	0 ▼	DSCP 34	0 ▼	DSCP 35	0 ▼
DSCP 36	0 ▼	DSCP 37	0 ▼	DSCP 38	0 ▼	DSCP 39	0 ▼
DSCP 40	0 ▼	DSCP 41	0 ▼	DSCP 42	0 ▼	DSCP 43	0 ▼
DSCP 44	0 ▼	DSCP 45	0 ▼	DSCP 46	0 ▼	DSCP 47	0 ▼
DSCP 48	0 ▼	DSCP 49	0 ▼	DSCP 50	0 ▼	DSCP 51	0 ▼
DSCP 52	0 ▼	DSCP 53	0 ▼	DSCP 54	0 ▼	DSCP 55	0 ▼
DSCP 56	0 ▼	DSCP 57	0 ▼	DSCP 58	0 ▼	DSCP 59	0 ▼
DSCP 60	0 ▼	DSCP 61	0 ▼	DSCP 62	0 ▼	DSCP 63	0 ▼

Apply
Refresh

Parameter	Description
-----------	-------------

DSCP Settings	
----------------------	--

Mode	“Tag Over DSCP” or “DSCP Over Tag”. “Tag Over DSCP” means the
------	---

	802.1p tag has higher priority than DSCP.
Priority	This field displays each priority level. The values range from 0 (lowest priority) to 7 (highest priority).
Apply	Click Apply to take effect the settings.
Refresh	Click Refresh to begin configuring this screen afresh.

6.4.1.3 Priority/Queue Mapping

6.4.1.3.1 CLI Configuration

Node	Command	Description
enable	show queue cos-map	This command displays the current 802.1p priority mapping to the service queue.
enable	configure terminal	This command changes the node to configure mode.
configure	queue cos-map <0-7> <0-7>	This command configures the 802.1p priority mapping to the service queue.
configure	no queue cos-map	This command configures the 802.1p priority mapping to the service queue to default.

Example:

```
L2SWITCH(config)#queue cos-map 0 1
Success!
L2SWITCH(config)#queue cos-map 1 2
Success!
L2SWITCH(config)#queue cos-map 2 3
Success!
L2SWITCH(config)#queue cos-map 3 4
Success!
L2SWITCH(config)#queue cos-map 4 5
Success!
L2SWITCH(config)#queue cos-map 5 6
Success!
L2SWITCH(config)#queue cos-map 6 7
Success!
L2SWITCH(config)#queue cos-map 7 0
Success!
L2SWITCH(config)#exit
L2SWITCH#show queue cos-map
The mapping of the Priority to Queue are:
  PRIO 0 ==> COSQ 1
  PRIO 1 ==> COSQ 2
  PRIO 2 ==> COSQ 3
  PRIO 3 ==> COSQ 4
  PRIO 4 ==> COSQ 5
  PRIO 5 ==> COSQ 6
  PRIO 6 ==> COSQ 7
  PRIO 7 ==> COSQ 0
```

6.4.1.3.2 Web Configuration

QoS

Port Priority
IP DiffServ (DSCP)
Priority/Queue Mapping
Schedule Mode

Priority/Queue Mapping Settings

Priority	Queue ID
0	<input type="text" value="1"/>
1	<input type="text" value="0"/>
2	<input type="text" value="2"/>
3	<input type="text" value="3"/>
4	<input type="text" value="4"/>
5	<input type="text" value="5"/>
6	<input type="text" value="6"/>
7	<input type="text" value="7"/>

Parameter	Description
Priority/Queue Mapping Settings	
Reset to Default	Click this button to reset the priority to queue mappings to the defaults.
Priority	This field displays each priority level. The values range from 0 (lowest priority) to 7 (highest priority).
Queue ID	Select the number of a queue for packets with the priority level.
Apply	Click Apply to take effect the settings.
Refresh	Click Refresh to begin configuring this screen afresh.

6.4.1.4 Schedule Mode

Queuing Algorithms

Queuing algorithms allow switches to maintain separate queues for packets from each individual source or flow and prevent a source from monopolizing the bandwidth.

- **Strict-Priority (SPQ)**
The packets on the high priority queue are always service firstly.

- **Weighted round robin (WRR)**
Round Robin scheduling services queues on a rotating basis and is activated only when a port has more traffic than it can handle. A queue is given an amount of bandwidth irrespective of the incoming traffic on that port. This queue then moves to the back of the list. The next queue is given an equal amount of bandwidth, and then moves to the end of the list; and so on, depending on the number of queues being used. This works in a looping fashion until a queue is empty.

Weighted Round Robin (WRR) scheduling uses the same algorithm as round robin scheduling, but services queues based on their priority and queue weight (the number you configure in the queue **Weight** field) rather than a fixed amount of bandwidth. WRR is activated only when a port has more traffic than it can handle. Queues with larger weights get more service than queues with smaller weights. This queuing mechanism is highly efficient in that it divides any available bandwidth across the different traffic queues and returns to queues that have not yet emptied.

6.4.1.4.1 CLI Configuration

Node	Command	Description
enable	show qos mode	This command displays the current QoS scheduling mode of IEEE 802.1p.
enable	configure terminal	This command changes the node to configure node.
configure	qos mode high-first	This command configures the QoS scheduling mode to high-first, each hardware queue will transmit all of the packets in its buffer before permitting the next lower priority to transmit its packets.
configure	qos mode wr-queue weights <1-127> <1-127> <1-127> <1-127> <1-127>	This command configures the QoS scheduling mode to Weighted Round Robin.

6.4.1.4.2 Web Configuration

QoS

Port Priority
IP DiffServ (DSCP)
Priority/Queue Mapping
Schedule Mode

Schedule Mode Settings

Schedule Mode: High First (SPQ) ▼

Queue ID	Weight Value(Range:1~127)
0	<input style="width: 80%;" type="text"/>
1	<input style="width: 80%;" type="text"/>
2	<input style="width: 80%;" type="text"/>
3	<input style="width: 80%;" type="text"/>
4	<input style="width: 80%;" type="text"/>
5	<input style="width: 80%;" type="text"/>
6	<input style="width: 80%;" type="text"/>
7	<input style="width: 80%;" type="text"/>

Apply
Refresh

Parameter	Description
Schedule Mode Settings	
Schedule Mode	Select Strict Priority (SP) or Weighted Round Robin (WRR) . Note: Queue weights can only be changed when Weighted Round Robin is selected. Weighted Round Robin scheduling services queues on a rotating basis based on their queue weight (the number you configure in the queue Weight field). Queues with larger weights get more service than queues with smaller weights.
Queue ID	This field indicates which Queue (0 to 7) you are configuring. Queue 0 has the lowest priority and Queue 7 the highest priority.
Weight Value	You can only configure the queue weights when Weighted Round Robin is selected. Bandwidth is divided across the different traffic queues according to their weights.
Apply	Click Apply to take effect the settings.
Refresh	Click Refresh to begin configuring this screen afresh.

6.4.2 Rate Limitation

6.4.2.1 Storm Control

A broadcast storm means that your network is overwhelmed with constant broadcast or multicast traffic. Broadcast storms can eventually lead to a complete loss of network connectivity as the packets proliferate.

Storm Control protects the Switch bandwidth from flooding packets, including broadcast packets, multicast packets, and destination lookup failure (DLF). The **Rate** is a threshold that limits the total number of the selected type of packets. For example, if the broadcast and multicast options are selected, the total amount of packets per second for those two types will not exceed the limit value.

Broadcast storm control limits the number of broadcast, multicast and unknown unicast (also referred to as Destination Lookup Failure or DLF) packets the Switch receives per second on the ports. When the maximum number of allowable broadcast, multicast and unknown unicast packets is reached per second, the subsequent packets are discarded. Enable this feature to reduce broadcast, multicast and unknown unicast packets in your network.

Storm Control unit: 652pps.

6.4.2.1.1 CLI Configuration

Node	Command	Description
enable	show storm-control	This command displays the current storm control configurations.
enable	configure terminal	This command changes the node to configure node.
configure	storm-control rate RATE_LIMIT type (bcast mcast DLF bcast+mcast bcast+DLF mcast+DLF bcast+mcast+DLF) ports PORTLISTS	This command enables the bandwidth limit for broadcast or multicast or DLF packets and set the limitation.
configure	no storm-controltype (bcast mcast DLF bcast+mcast bcast+DLF mcast+DLF bcast+mcast+DLF) ports PORTLISTS	This command disables the bandwidth limit for broadcast or multicast or DLF packets.

Example:

```
L2SWITCH#configure terminal
L2SWITCH(config)#storm-control rate 1 type broadcast ports 1-6
L2SWITCH(config)#storm-control rate 1 type multicast ports 1-6
L2SWITCH(config)#storm-control rate 1 type DLF ports 1-6
```

6.4.2.1.2 Web Configuration

Rate Limitation

Storm Control
Bandwidth Limitation

Storm Control Settings

Port	Rate	Type
From: <input type="text" value="1"/> To: <input type="text" value="1"/>	<input type="text" value="0"/> (units)	<input type="text" value="Broadcast"/>

(0:Disable. One unit is about 652 pps.)

Storm Control Status

Port	Rate(units)	Multicast	Broadcast	DLF
1	1	Disable	Enable	Enable
2	1	Disable	Enable	Enable
3	1	Disable	Enable	Enable
4	1	Disable	Enable	Enable
5	1	Disable	Enable	Enable
6	1	Disable	Enable	Enable
7	1	Disable	Enable	Enable
8	1	Disable	Enable	Enable
9	1	Disable	Enable	Enable
10	1	Disable	Enable	Enable
11	1	Disable	Enable	Enable
12	1	Disable	Enable	Enable

Parameter	Description
Storm Control Settings	
Port	Select the port number for which you want to configure storm control settings.
Rate	Select the number of packets (of the type specified in the Type field) per second the Switch can receive per second.
Type	Select Broadcast - to specify a limit for the amount of broadcast packets received per second. Multicast - to specify a limit for the amount of multicast packets received per second. DLF - to specify a limit for the amount of DLF packets received per second. Or other combinations such as Bcast+Mcast , Bcast_DLF , Mcast+DLF , Bcast+Mcast+DLF .
Apply	Click Apply to take effect the settings.
Refresh	Click Refresh to begin configuring this screen afresh.

6.4.2.2 Bandwidth Limitation

The rate limitation is used to control the rate of traffic sent or received on a network interface.

Rate Limitation unit: Mbps.

Default Settings

All ports' Ingress and Egress rate limitation are disabled.

6.4.2.2.1 CLI Configuration

Node	Command	Description
enable	show bandwidth-limit	This command displays the current rate control configurations.
enable	configure terminal	This command changes the node to configure node.
configure	bandwidth-limit egress RATE_LIMIT ports PORTLISTS	This command enables the bandwidth limit for outgoing packets and set the limitation.
configure	no bandwidth-limit egress ports PORTLISTS	This command disables the bandwidth limit for outgoing packets.
configure	bandwidth-limit ingress RATE_LIMIT ports PORTLISTS	This command enables the bandwidth limit for incoming packets and set the limitation.
configure	no bandwidth-limit ingress ports PORTLISTS	This command disables the bandwidth limit for incoming packets.

Example:

```
L2SWITCH#configure terminal
L2SWITCH(config)#bandwidth-limit ingress 1 ports 1-3
Success!
```

6.4.2.2.2 Web Configuration

Rate Limitation

Storm Control
Bandwidth Limitation

Bandwidth Limitation Settings

Port	Ingress	Egress
From: <input type="text" value="1"/> To: <input type="text" value="1"/>	<input type="text" value="0"/> (Mbps)	<input type="text" value="0"/> (Mbps)

(Disable: 0)

Bandwidth Limitation Status

Port	Ingress (Mbps)	Egress (Mbps)	Port	Ingress (Mbps)	Egress (Mbps)
1	0	0	2	0	0
3	0	0	4	0	0
5	0	0	6	0	0
7	0	0	8	0	0
9	0	0	10	0	0
11	0	0	12	0	0

Parameter	Description
Bandwidth Limitation Settings	
Port	Selects a port that you want to configure.
Ingress	Configures the rate limitation for the ingress packets.
Egress	Configures the rate limitation for the egress packets.
Apply	Click Apply to take effect the settings.
Refresh	Click Refresh to begin configuring this screen afresh.

6.5 IGMP Snooping

6.5.1 IGMP Snooping

The IGMP snooping is for multicast traffic. The Switch can passively snoop on IGMP packets transferred between IP multicast routers/switches and IP multicast hosts to learn the IP multicast group membership. It checks IGMP packets passing through it, picks out the group registration information, and configures multicasting accordingly. IGMP snooping allows the Switch to learn multicast groups without you having to manually configure them.

The Switch can passively snoop on IGMP packets transferred between IP multicast routers/switches and IP multicast hosts to learn the IP multicast group membership. It checks IGMP packets passing through it, picks out the group registration information, and configures multicasting accordingly. IGMP snooping allows the Switch to learn multicast groups without you having to manually configure them.

The Switch forwards multicast traffic destined for multicast groups (that it has learned from IGMP snooping or that you have manually configured) to ports that are members of that group. IGMP snooping generates no additional network traffic, allowing you to significantly reduce multicast traffic passing through your Switch.

The Switch can perform IGMP snooping on up to 4094 VLANs. You can configure the Switch to automatically learn multicast group membership of any VLANs. The Switch then performs IGMP snooping on the first VLANs that send IGMP packets. Alternatively, you can specify the VLANs that IGMP snooping should be performed on. This is referred to as fixed mode. In fixed mode the Switch does not learn multicast group membership of any VLANs other than those explicitly added as an IGMP snooping VLAN.

IGMP snooping report suppression:

This feature enables the Layer 2 device to forward only the first IGMP report for a multicast group to its directly connected Layer 3 device. Other reports for the same group in the same query interval are discarded. Use this feature to reduce multicast traffic.

Configurations:

Users can enable/disable the IGMP Snooping on the Switch. Users also can enable/disable the IGMP Snooping on a specific VLAN. If the IGMP Snooping on the Switch is disabled, the IGMP Snooping is disabled on all VLANs even some of the VLAN IGMP Snooping are enabled.

Default Settings

If received packets are not received after 400 seconds, all multicast entries will be deleted.

The default global IGMP snooping state is disabled.

The default VLAN IGMP snooping state is disabled for all VLANs.

The unknown multicast packets will be dropped.

The default port Immediate Leave state is disabled for all ports.

The default port Querier Mode state is auto for all ports.

The IGMP snooping Report Suppression is disabled.

Notices: There are a global state and per VLAN states. When the global state is disabled, the IGMP snooping on the Switch is disabled even per VLAN states are enabled. When the global state is enabled, user must enable per VLAN states to enable the IGMP Snooping on the specific VLAN.

6.5.1.1 General Settings

6.5.1.1.1 CLI Configuration

Node	Command	Description
enable	show igmp-snooping	This command displays the current IGMP snooping configurations.
enable	show igmp-snooping counters	This command displays the current IGMP snooping counters.
enable	configure terminal	This command changes the node to configure node.
configure	clear igmp-snooping counters	This command clears all of the IGMP snooping counters.
configure	igmp-snooping (disable enable)	This command disables / enables the IGMP snooping on the switch.
configure	igmp-snooping report-suppression (disable enable)	This command disables / enables the IGMP snooping report suppression function on the switch.
configure	igmp-snooping vlan VLANID	This command enables the IGMP snooping function on a VLAN or range of VLANs.
configure	no igmp-snooping vlan VLANID	This command disables the IGMP snooping function on a VLAN or range of VLANs.
configure	igmp-snooping unknown-multicast (drop flooding)	This command configures the process for unknown multicast packets when the IGMP snooping function is enabled. drop: Drop all of the unknown multicast packets. flooding: Flooding the unknown multicast packets to all ports.

Example:

```
L2SWITCH(config)#igmp-snooping enable
```

```
L2SWITCH(config)#igmp-snooping vlan 1
```

6.5.1.1.2 Web Configuration

IGMP Snooping

General Settings
Port Settings
Querier Settings

IGMP Snooping Settings

IGMP Snooping State Disable ▾

Report Suppression State Disable ▾

IGMP Snooping VLAN State Add ▾

Unknown Multicast Packets Flooding ▾

IGMP Snooping State

IGMP Snooping State	Disabled
Report Suppression State	Disabled
Enabled on VLAN	None
Unknown Multicast Packets	Flooding

Parameter	Description
IGMP Snooping Settings	
IGMP Snooping State	Select Enable to activate IGMP Snooping to forward group multicast traffic only to ports that are members of that group. Select Disable to deactivate the feature.
Report Suppression State	Select Enable/Disable to activate/deactivate IGMP report suppression function.
IGMP Snooping VLAN State	Select Add and enter VLANs upon which the Switch is to perform IGMP snooping. The valid range of VLAN IDs is between 1 and 4094. Use a comma (,) or hyphen (-) to specify more than one VLANs. Select Delete and enter VLANs on which to have the Switch not perform IGMP snooping.
Unknown Multicast Packets	Specify the action to perform when the Switch receives an unknown multicast frame. Select Drop to discard the frame(s). Select Flooding to send the frame(s) to all ports.
Apply	Click Apply to take effect the settings.
Refresh	Click Refresh to begin configuring this screen afresh.
IGMP Snooping Status	
IGMP Snooping State	This field displays whether IGMP snooping is globally enabled or disabled.
Report Suppression State	This field displays whether IGMP report suppression is globally enabled or disabled.

Enable on VLAN	This field displays VLANs on which the Switch is to perform IGMP snooping. None displays if you have not enabled IGMP snooping on any VLAN yet.
Unknown Multicast Packets	This field displays whether the Switch is set to drop or flooding unknown multicast packets.

6.5.1.2 Port Settings

Immediate Leave

When you enable IGMP Immediate-Leave processing, the switch immediately removes a port when it detects an IGMP version 2 leave message on that port. You should use the Immediate-Leave feature only when there is a single receiver present on every port in the VLAN. (Immediate Leave is only supported on IGMP Version 2 hosts).

The switch uses IGMP snooping Immediate Leave to remove from the forwarding table an interface that sends a leave message without the switch sending group-specific queries to the interface. The VLAN interface is pruned from the multicast tree for the multicast group specified in the original leave message. Immediate Leave ensures optimal bandwidth management for all hosts on a switched network, even when multiple multicast groups are simultaneously in use.

Without Immediate Leave, when the switch receives an IGMP leave message from a subscriber on a receiver port, it sends out an IGMP specific query on that port and waits for IGMP group membership reports. If no reports are received in a configured time period, the receiver port is removed from multicast group membership.

Port IGMP Querier Mode

- **Auto:**

The Switch uses the port as an IGMP query port if the port receives IGMP query packets.

- **Fixed:**

The Switch always treats the port(s) as IGMP query port(s). This is for when connecting an IGMP multicast server to the port(s). The Switch always forwards the client's **report/leave** packets to the port.

Normally, the port is connected to an IGMP server.

- **Edge:**

The Switch does not use the port as an IGMP query port. The IGMP query packets received by this port will be dropped.

Normally, the port is connected to an IGMP client.

Note: The Switch will forward the IGMP join and leave packets to the query port.

6.5.1.2.1 CLI Configuration

Node	Command	Description
enable	show igmp-snooping	This command displays the current IGMP snooping configurations.

enable	configure terminal	This command changes the node to configure node.
configure	interface IFNAME	This command enters the interface configure node.
interface	igmp-immediate-leave	This command enables the IGMP Snooping immediate leave function for the specific port.
interface	no igmp-immediate-leave	This command disables the IGMP Snooping immediate leave function for the specific port.
interface	igmp-group-limit VALUE	This command configures the maximum groups for the specific port.
interface	no igmp-group-limit	This command configures the default value for the limitation of the maximum groups for the specific port.
interface	igmp-querier-mode (auto fixed edge)	This command specifies whether or not and under what conditions the port(s) is (are) IGMP query port(s). The Switch forwards IGMP join or leave packets to an IGMP query port, treating the port as being connected to an IGMP multicast router (or server). You must enable IGMP snooping as well. (Default: auto)
configure	interface range gigabitethernet1/0/POR TLISTS	This command enters the if-range configure node.
if-range	igmp-immediate-leave	This command enables the IGMP Snooping immediate leave function for the specific ports.
if-range	no igmp-immediate-leave	This command disables the IGMP Snooping immediate leave function for the specific ports.
if-range	igmp-group-limit VALUE	This command configures the maximum groups for the specific port.
if-range	no igmp-group-limit	This command configures the default value for the limitation of the maximum groups for the specific port.
if-range	igmp-querier-mode (auto fixed edge)	This command specifies whether or not and under what conditions the ports is (are) IGMP query port(s). The Switch forwards IGMP join or leave packets to an IGMP query port, treating the port as being connected to an IGMP multicast router (or server). You must enable IGMP snooping as well. (Default: auto)

6.5.1.2.2 Web Configuration

IGMP Snooping

General Settings
Port Settings
Querier Settings

Port Settings

Port	Querier Mode	Immediate Leave	Group Limit
From: <input type="text" value="1"/> To: <input type="text" value="1"/>	<input type="text" value="Auto"/>	<input type="text" value="Disable"/>	<input type="text" value="266"/>

Port Status

Port	Querier Mode	Immediate Leave	Group/Limit	Port	Querier Mode	Immediate Leave	Group/Limit
1	Auto	Disable	0/266	2	Auto	Disable	0/266
3	Auto	Disable	0/266	4	Auto	Disable	0/266
5	Auto	Disable	0/266	6	Auto	Disable	0/266
7	Auto	Disable	0/266	8	Auto	Disable	0/266
9	Auto	Disable	0/266	10	Auto	Disable	0/266
11	Auto	Disable	0/266	12	Auto	Disable	0/266

Parameter	Description
Port Settings	
Querier Mode	Select the desired setting, Auto , Fixed , or Edge . Auto means the Switch uses the port as an IGMP query port if the port receives IGMP query packets. Fixed means the Switch always treats the port(s) as IGMP query port(s). This is for when connecting an IGMP multicast server to the port(s). Edge means the Switch does not use the port as an IGMP query port. In this case, the Switch does not keep a record of an IGMP router being connected to this port and the Switch does not forward IGMP join or leave packets to this port.
Immediate Leave	Select individual ports on which to enable immediate leave.
Group Limit	Configures the maximum group for the port or a range of ports.
Apply	Click Apply to take effect the settings.
Refresh	Click Refresh to begin configuring this screen afresh.

6.5.1.3 Querier Settings

IGMP Querier

There is normally only one Querier per physical network. All multicast routers start up as a Querier on each attached network. If a multicast router hears a Query message from a router **with a lower IP address**, it MUST become a Non-Querier on that network. If a router has not heard a Query message from another router for [Other Querier Present Interval], it resumes the role of Querier. Routers periodically [Query Interval] send a General Query on each attached network for which this router is the Querier, to solicit membership information. On startup, a router SHOULD send [Startup Query Count] General Queries spaced closely together [Startup Query Interval] in order to quickly and reliably determine membership information. A General Query is addressed to the all-systems multicast group (224.0.0.1), has a Group Address field of 0, and has a Max Response Time of [Query Response Interval].

6.5.1.3.1 CLI Configuration

Node	Command	Description
enable	show igmp-snooping querier	This command displays the current IGMP Queriers.
enable	configure terminal	This command changes the node to configure node.
configure	igmp-snooping querier (disable enable)	This command disables / enables the IGMP snooping querier on the Switch.
configure	igmp-snooping querier vlan VLANIDs	This command enables the IGMP snooping querier function on a VLAN or range of VLANs.
configure	no igmp-snooping querier vlan VLANIDs	This command disables the IGMP snooping querier function on a VLAN or range of VLANs.
configure	igmp-snooping query interval <2-300>	This command configures the query interval for the Querier. Unit: second.

6.5.1.3.2 Web Configuration

IGMP Snooping

General Settings
Port Settings
Querier Settings

Querier Settings

State: ▾

Query Interval: (sec)

VLAN State: ▾

Querier Status

State	Disable
Query Interval	125 (sec)
Enabled on VLAN	None

Parameter	Description
Querier Settings	
State	This field configures the global Querier state.
Query Interval	This field configures the interval which Querier send query packet periodically.
VLAN State	This field enables the Querier state in a vlan or a range of vlan.
Apply	Click Apply to take effect the settings.
Refresh	Click Refresh to begin configuring this screen afresh.
Querier Status	
State	This filed indicates the current global Querier status.
Query Interval	This field indicates the interval which Querier send query packet periodically.
Enable on VLAN	This field displays VLANs on which the Switch is to perform IGMP querier. None displays if you have not enabled IGMP querier on any VLAN yet.

6.5.2 IGMP Snooping Filtering

The IGMP Snooping Filter allows users to configure one or some of range or multicast address to drop or to forward them.

6.5.2.1 General Settings

6.5.2.1.1 CLI Configurations

Node	Command	Description
enable	show igmp-snooping filtering	This command displays the IGMP snooping filtering configurations.
enable	configure terminal	This command changes the node to configure node.
configure	igmp-snooping filtering (enable disable)	This command enables/disables the IGMP snooping filtering profiles on the Switch.
configure	igmp-snooping filtering profile STRING	This command creates a filtering profile and enters the IGMP snooping filtering profiles configuration node.
configure	no igmp-snooping filtering all	This command removes all of the IGMP snooping filtering profiles from the Switch.
configure	no igmp-snooping filtering STRINGS	This command removes the IGMP snooping filtering profiles by name from the Switch.
config-igmp	type (deny permit)	This command configures the type of deny or permit for the group.

6.5.2.1.2 Web Configurations

IGMP Filtering

General Settings
Multicast Groups
Port Settings

IGMP Filtering Settings

IGMP Filtering State: Disable ▾

Profile	Type
<input style="width: 95%;" type="text"/>	Deny ▾

Apply
Refresh

IGMP Filtering Status

Profile	Type	Ports	Action

Parameter	Description
-----------	-------------

IGMP Filtering Settings

IGMP Filtering State	This field configures the global IGMP Filtering state.
----------------------	--

Profile	This field creates the IGMP Filtering profile.
Type	The field configures the type of action for the profile.
Apply	Click Apply to take effect the settings.
Refresh	Click Refresh to begin configuring this screen afresh.
IGMP Filtering Status	
Profile	The profile name.
Type	The type of action.
Ports	The field indicates the ports that the IGMP Filtering profile is activated.
Action	Click Delete to delete the profile.

6.5.2.2 Group Settings

6.5.2.2.1 CLI Configurations

Node	Command	Description
enable	show igmp-snooping filtering	This command displays the IGMP snooping filtering configurations.
enable	configure terminal	This command changes the node to configure node.
configure	igmp-snooping filtering profile STRING	This command creates a filtering profile and enters the IGMP snooping filtering profiles configuration node.
config-igmp	Group GROUP_ID start-address START-ADDR end-address END-ADDR	This command configures the group configurations, including group index and start multicast address and end multicast address.
config-igmp	no group GROUP-ID	This command removes the group configurations.
config-igmp	no group all	This command removes all of the group configurations.

6.5.2.2.2 Web Configurations

IGMP Filtering

General Settings
Multicast Groups
Port Settings

Group Settings

Profile:

Group	Start Address	End Address
1 <input type="text" value=""/>	<input type="text" value=""/>	<input type="text" value=""/>

Group Status

Profile	Type	Group	Start Address	End Address	Action

Parameter	Description
Group Settings	
Profile	This field selects the profile which you want to configure the group.
Group	This field selects the group index.
Start Address	The field configures the first multicast address of the group.
End Address	The field configures the last multicast address of the group.
Apply	Click Apply to take effect the settings.
Refresh	Click Refresh to begin configuring this screen afresh.

6.5.2.3 Port Settings

6.5.2.3.1 CLI Configurations

Node	Command	Description
enable	show igmp-snooping filtering	This command displays the IGMP snooping filtering configurations.
enable	configure terminal	This command changes the node to configure node.
configure	interface IFNAME	This command enters the interface configure node.
interface	igmp-snooping filtering profile STRING	This command enables the IGMP snooping filtering profiles on the range of ports.
interface	no igmp-snooping filtering profile STRINGS	This command disables the IGMP snooping filtering profiles on the range of ports.
configure	interface range gigabitethernet1/0/PORTLISTS	This command enters the if-range configure node.
if-config	igmp-snooping filtering profile STRING	This command enables the IGMP snooping filtering profiles on the range of ports.
if-config	no igmp-snooping filtering profile STRINGS	This command disables the IGMP snooping filtering profiles on the range of ports.

6.5.2.3.2 Web Configurations

IGMP Filtering

General Settings
Multicast Groups
Port Settings

Port Settings

Profile :

Activate on Ports

Select All Deselect All

2 4 6 8 10 12

1 3 5 7 9 11

Port Status

Profile	Type	Port

Parameter	Description
Port Settings	
Profile	This field selects the profile which you want to activate on the ports.
Activate on Ports	Selects the ports which you want to activate the IGMP Filtering profile.

Apply	Click Apply to take effect the settings.
Refresh	Click Refresh to begin configuring this screen afresh.

6.5.3 Multicast Listener Discovery (MLD) Snooping for IPv6

Multicast Listener Discovery Snooping is an IPv6 multicast constraining mechanism that runs on layer 2 switches to manage and control IPv6 multicast groups. With MLDS, IPv6 multicast data is selectively forwarded to a list of ports that want to receive the data, instead of being flooded to all ports in a VLAN. This list is constructed by snooping IPv6 multicast control packets. In general, significant bandwidth can be wasted by flooding.

Functionality

Presently our layer 2 switches support IGMP Snooping in IPV4. IGMP snooping to limit the flooding of multicast traffic by dynamically configuring Layer 2 interfaces so that multicast traffic is forwarded to only those interfaces associated with IP multicast devices.

The functionality of IGMP Snooping in IPv4 version is same as MLD Snooping in IPv6 version.

MLDS supports two versions:

- ✓ MLDv1 snooping detects MLDv1 control packets and sets up traffic bridging based on IPv6 destination multicast addresses.
- ✓ MLDv2 basic snooping uses MLDv2 control packets to set up traffic forwarding based on IPv6 destination multicast addresses.

Proxy reporting:

All the hosts send their complete multicast group membership information to the multicast router in response to queries. The switch snoop these responses, updates the database and forwards the reports to the multicast router. To prevent the multicast router from becoming overloaded with reports, MLD snooping does proxy reporting. Proxy reporting forwards only the first report for a multicast group to the router and suppresses all other reports for the same multicast group.

Report-suppression-interval

Only one report is forwarded within the report forward interval for a particular group.

Querier:

When enabled, the MLD snooping querier sends out periodic MLD queries that trigger MLD report messages from the switch that wants to receive IP multicast traffic. MLD snooping listens to these MLD reports to establish appropriate forwarding. You can enable the MLD snooping querier on all the switches in the VLAN, but for each VLAN that is connected to switches that use MLD to report interest in IP multicast traffic, you must configure at least one switch as the MLD snooping querier.

6.5.3.1 General Settings

6.5.3.1.1 CLI Configuration

Node	Command	Description
enable	show mld-snooping information	This command displays the current MLD configurations.
enable	show mld-snooping group	This command displays the current MLD group information.
enable	configure terminal	This command changes the node to configure node.
configure	mld-snooping enable	This command enables the MLD Snooping.
configure	no mld-snooping enable	This command disables the MLD Snooping.
configure	mld-snooping proxy enable	This command enables the MLD Snooping Proxy. (Default: disable)
configure	no mld-snooping proxy enable	This command disables the MLD Snooping Proxy.
configure	mld-snooping forward-mode(ip mac)	This command configures the MLD Snooping forward mode.
configure	no mld-snooping forward-mode	This command resets the MLD Snooping forward mode to MAC base forward.
configure	mld-snooping router-interval<60-600>	This command configures the MLD Snooping router interval.
configure	no mld-snooping router-interval	This command resets the MLD Snooping router interval to 125 seconds.
configure	mld-snooping port-interval<130-1225>	This command configures the MLD Snooping port interval.
configure	no mld-snooping port-interval	This command resets the MLD Snooping port interval to 260 seconds.
configure	mld-snooping report-suppression-interval<1-25>	This command configures the MLD Snooping report suppression interval.
configure	no mld-snooping report-suppression-interval	This command resets the MLD Snooping report suppression interval to 5 seconds.
configure	mld-snooping group-query-interva<2-5>	This command configures the MLD Snooping group query interval.
configure	no mld-snooping group-query-interval	This command resets the MLD Snooping group query interval to 2 seconds.
configure	mld-snooping forward-report-mode(all-port s router-ports)	This command configures the MLD Snooping forward report mode.
configure	no mld-snooping forward-report-mode	This command resets the MLD Snooping forward report mode to router-ports.
configure	mld-snooping querier enable	This command enables the MLD Snooping querier. (Default: disable)
configure	no mld-snooping querier enable	This command disables the MLD Snooping querier.

6.5.3.1.2 Web Configuration

MLD Snooping

General Settings
VLAN Settings

MLD Snooping Settings

Global State	Disable <input type="button" value="v"/>	Router Interval	125 (60~600, Default:125)
Proxy State	Disable <input type="button" value="v"/>	Report Suppression Interval	5 (1~25, Default:5)
Querier State	Disable <input type="button" value="v"/>	Port Interval	260 (130~1225, Default:260)
Forward Report Mode	router-ports <input type="button" value="v"/>	Group Query Interval	2 (2~5, Default:2)

MLD Snooping Status

Global State	Disable	Router Interval	125
Proxy State	Disable	Report Suppression Interval	5
Querier State	Disable	Port Interval	260
Forward Report Mode	router-ports	Group Query Interval	2

Parameter	Description
MLD Snooping Settings	
Global State	Configures the global state of the MLD snooping on the Switch.
Router Interval	Configures the MLD Snooping router interval.
Proxy State	Enables / Disables the MLD Snooping Proxy state on the Switch.
Report Suppression Interval	Configures the MLD Snooping report suppression interval.
Querier State	Enables / Disables the MLD Snooping querier state on the Switch.
Port Interval	Configures the MLD Snooping port interval.
Forward Report Mode	all-ports - Report forwards on all existing ports. router-ports -Report forwards on router ports only.
Group Querier Interval	Configures the MLD Snooping group querier interval.
Apply	Click Apply to take effect the settings.
Refresh	Click Refresh to begin configuring this screen afresh.

6.5.4 VLAN Settings

6.5.4.1 CLI Configuration

Node	Command	Description
enable	show mld-snooping information	This command displays the current MLD configurations.
enable	show mld-snooping group	This command displays the current MLD group information.
enable	configure terminal	This command changes the node to configure node.
configure	mld-snooping vlan <1-4094>	This command enters the MLD Snooping configure node.
configure	no mld-snooping vlan <1-4094>	This command removes the MLD Snooping.
mld_vlan	enable	This command enables the MLD Snooping on the vlan. (Default: enable)
mld_vlan	no enable	This command disables the MLD Snooping on the vlan.
mld_vlan	version (v1 v2)	This command configures the MLD Snooping version.
mld_vlan	no version	This command resets the MLD Snooping version to default v1.
mld_vlan	immediate-leave enable	This command enables the MLD Snooping immediate leave. (Default: disable)
mld_vlan	no immediate-leave enable	This command disables the MLD Snooping immediate leave.
mld_vlan	querier enable	This command enables the MLD Snooping Querier. (Default: disable)
mld_vlan	no querier enable	This command disables the MLD Snooping Querier.
mld_vlan	query-interval <60-600>	This command configures the MLD Snooping query interval.
mld_vlan	no query-interval	This command resets the MLD Snooping query interval to default 125.
mld_vlan	router-port PORTID	This command configures the MLD Snooping router port.
mld_vlan	no router-port PORTID	This command removes the MLD Snooping router port.
mld_vlan	end	This command enables the MLD Snooping.
mld_vlan	exit	This command enables the MLD Snooping.

6.5.4.2 Web Configuration

MLD Snooping

General Settings
VLAN Settings

VLAN Settings

VLAN ID	<input type="text" value="1"/>	Query Interval	<input type="text" value="125"/> (60~600, Default:125)
VLAN State	<input type="text" value="Disable"/>	Version	<input type="text" value="v1"/>
Immediate Leave	<input type="text" value="Disable"/>	Querier	<input type="text" value="Disable"/>
Router Port	<input type="text" value="Add"/>		

VLAN Status

VLAN ID	State	Version	Immediate Leave	Querier	Router Port	Query Interval	Action
---------	-------	---------	-----------------	---------	-------------	----------------	--------

Parameter	Description
VLAN Settings	
VLAN ID	Select the vlan which you want to configure.
Query Interval	Configures the query interval for the vlan.
VLAN State	Enables / Disables the MLD Snooping on the vlan.
Version	Selects the MLD Snooping version on the vlan.
Immediate Leave	Enables / Disables the MLD Snooping immediate leave on the vlan.
Querier	Enables / Disables the MLD Snooping querier on the vlan.
Router Port	Add – add port(s) in the router port list for MLD Snooping on the vlan. Remove – remove port(s) from the router port list for MLD Snooping on the vlan.
Apply	Click Apply to take effect the settings.
Refresh	Click Refresh to begin configuring this screen afresh.

6.5.5 MVR

MVR refers to **Multicast VLAN Registration** that enables a media server to transmit multicast stream in a single multicast VLAN while clients receiving multicast VLAN stream can reside in different VLANs. Clients in different VLANs intend to join or leave the multicast group simply by sending the IGMP Join/leave message to a **receiver** port. The receiver port belonging to one of the multicast groups can receive multicast stream from media server. Without support of MVR, the Multicast stream from media server and subscriber must reside in the same VLAN.

- Source ports : The Stream source ports.
- Receiver ports : The Client ports.
- Tagged ports : Configure the tagged ports for source ports or receiver ports.

MVR Mode

- **Dynamic Mode:**

If we select the dynamic mode in MVR setting, IGMP report message transmitted from the receiver port will be forwarded to a multicast router through its source port. Multicast router knows which multicast groups exist on which interface dynamically.

- **Compatible mode:**

If we select the dynamic mode in MVR setting, IGMP report message transmitted from the receiver port will not be transmitted to a multicast router.

Operation Mode

- **Join Operation:**

A subscriber sends an IGMP report message to the switch to join the appropriate multicast. The next depends on whether the IGMP report matches the switch configured multicast MAC address. If it matches, the switch CPU modifies the hardware address table to include this receiver port and VLAN as a forwarding destination of MVLAN.

- **Leave Operation:**

Subscriber sends an IGMP leave message to the switch to leave the multicast. The switch CPU sends an IGMP group-specific query through the receiver port VLAN. If there is another subscriber in the VLAN, subscriber must respond within the max response time. If there is no subscriber, the switch would eliminate this receiver port.

- **Immediate Leave Operation:**

Subscriber sends an IGMP leave message to the switch to leave the multicast. Subscribers do not need to wait for the switch CPU to send an IGMP group-specific query through the receiver port VLAN. The switch will immediately eliminate this receiver port.

Figure-1:

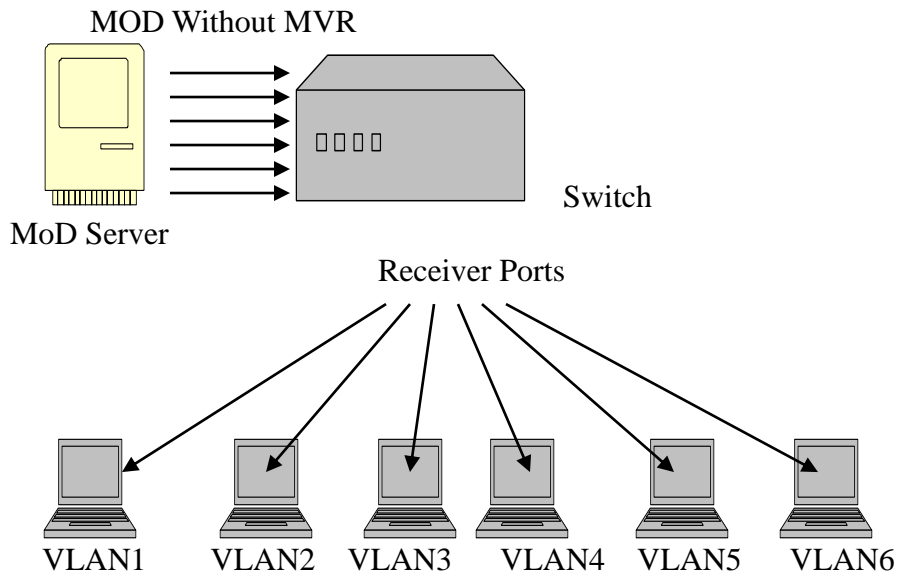
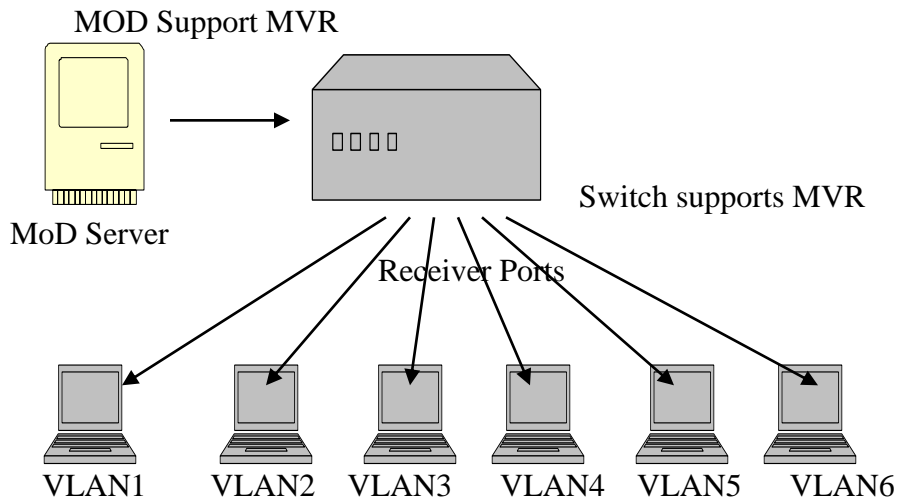

Figure-2:



Default Settings

There is no MVR vlan.

Default configuration for a new MVR:

MVR VLAN Information

VLAN ID	: 2
Name	: MVR2
Active	: Enabled
Mode	: Dynamic
Source Port(s)	: None
Receiver Port(s)	: None
Tagged Port(s)	: None

The Switch allows user to create up to 250 groups.

The Switch allows user to create up to 16 MVRs.

Notices

- IGMP snooping and MVR can be independently enabled.
- IGMP snooping and MVR use the same IGMP timers.
- MVR can recognize IGMPv3 reports.
- About the IGMPv3 report, switch doesn't treat those group records with the following group record types as membership reports. Those group record types are `MODE_IS_INCLUDE`, `CHANGE_TO_INCLUDE_MODE`, `ALLOW_NEW_SOURCES` and `BLOCK_OLD_SOURCES`.
- Don't use the group address X.0.0.1 for your multicast stream. It is because the system detects and records the 224.0.0.1 for dynamic querier port. The group address X.0.0.1 may conflict with 224.0.0.1.
- Because the lower 23 bits of the 28-bit multicast IP address are mapped into the 23 bits of available Ethernet address space. When you configure group address, the Switch compares the lower 23 bits only.
- CLI command "`group 1 start-address 224.1.1.1 6`", it creates 6 groups. That is, one IP, one group.
- The MVR name should be the combination of the digit or the alphabet.
- The group name should be the combination of the digit or the alphabet.

6.5.5.1 MVR Settings

6.5.5.1.1 CLI Configuration

Node	Command	Description
enable	show mvr	This command displays the current MVR configurations.
enable	show mvr vlan VLANLISTS	This command displays the current MVR configurations of the specific VLAN.
enable	configure terminal	This command changes the node to configure node.
configure	mvr VLANLISTS	This command configures the MVR configurations for the specific VLAN.
configure	no mvr VLANLISTS	This command disables the MVR configurations for the specific VLAN.
MVR	inactive	This command disables the MVR settings.
MVR	no inactive	This command enables the MVR settings.
MVR	mode (dynamic compatible)	This command configures the mode for the MVR. <ul style="list-style-type: none"> ● Dynamic : Sends IGMP report to all MVR source ports in the multicast VLAN. ● Compatible : Sets the Switch not to send IGMP report.
MVR	name STRING	This command configures the name for the MVR.
MVR	no name	This command configures the default name for the MVR.
MVR	receiver-port PORTLIST	This command sets the receiver port(s). Normally the source ports are connected to the streaming client.
MVR	no receiver-port PORTLIST	This command removes a port or range of ports from the receiver port(s).
MVR	source-port	This command sets the source port(s). Normally the

	PORTLIST	source ports are connected to the streaming server.
MVR	no source-port PORTLIST	This command removes a port or range of ports from the source port(s).
MVR	tagged PORTLIST	This command sets the tagged port(s). Same as the VLAN tagged port.
MVR	no tagged PORTLIST	This command removes a port or range of ports from the tagged port(s).
MVR	priority-override (disable enable)	This command enables/disables the multicast priority override.

6.5.5.1.2 Web Configuration

Multicast VLAN Registration

MVR Settings
Group Settings

MVR Settings

VLAN	<input type="text"/>	Name	<input type="text"/>	Priority Override	<input type="text" value="Disable"/>
State	<input type="text" value="Enable"/>	Mode	<input type="text" value="Dynamic"/>	802.1p Priority	<input type="text" value="0"/>
Source Ports	<input type="text"/>				
	<small>(ex. 1,3,5-8)</small>				
Receiver Ports	<input type="text"/>				
	<small>(ex. 1,3,5-8)</small>				
Tagged Ports	<input type="text"/>				
	<small>(ex. 1,3,5-8)</small>				

MVR Status

Parameter	Description
MVR Setting	
VLAN ID	Configures a VLAN.
NAME	Configures a name for the MVR.
Priority Override	Enable / Disable for the priority override.
State	Enables / Disables the MVR.
Mode	Configures the mode for the MVR.
802.1p Priority	The priority for these multicast group packets.

Source Ports	Configures the source port(s) for the MVR. Normally the source ports are connected to the streaming server.
Receive Ports	Configures the receive port(s) for the MVR. Normally the source ports are connected to the streaming client
Tagged Ports	Configures the tagged port(s) for the MVR. Same as the VLAN tagged port.
Apply	Click Apply to take effect the settings.
Refresh	Click Refresh to begin configuring this screen afresh.

6.5.5.2 Group Settings

6.5.5.2.1 CLI Configuration

Node	Command	Description
enable	show mvr	This command displays the current MVR configurations.
enable	show mvr vlan VLANLISTS	This command displays the current MVR configurations of the specific VLAN.
enable	configure terminal	This command changes the node to configure node.
configure	mvr VLANLISTS	This command configures the MVR configurations for the specific VLAN.
MVR	group STRING start-address IPADDR VALUE	This command configures a multicast group configuration for the MVR.
MVR	no group	This command removes all of the multicast group configurations from the MVR.
MVR	no group name STRING	This command removes the multicast group configurations from the MVR.

6.5.5.2.2 Web Configuration

Multicast VLAN Registration

MVR Settings
Group Settings

Group Settings

MVR VLAN

Group Name

Start Address Quantity:

Group Status

Parameter	Description
Group Setting	
MVR VLAN	Select a MVR VLAN.
Group Name	Configures the group name.
Start Address	Configures the multicast start address.
Quantity	Configures the quantity of the multicast address.
Apply	Click Apply to take effect the settings.
Refresh	Click Refresh to begin configuring this screen afresh.

6.5.6 Multicast Address

A multicast address is associated with a group of interested receivers. According to RFC 3171, addresses 224.0.0.0 to 239.255.255.255, the former Class D addresses, are designated as multicast addresses in IPv4.

The IANA owns the OUI MAC address 01:00:5e, therefore multicast packets are delivered by using the Ethernet MAC address range 01:00:5e:00:00:00 - 01:00:5e:7f:ff:ff. This is 23 bits of available address space.

The first octet (01) includes the broadcast/multicast bit. The lower 23 bits of the 28-bit multicast IP address are mapped into the 23 bits of available Ethernet address space. This means that there is ambiguity in delivering packets. If two hosts on the same subnet each subscribe to a different multicast group whose address differs only in the first 5 bits, Ethernet packets for both multicast groups will be delivered to both hosts, requiring the network software in the hosts to discard the un-required packets.

Class	Address Range	Supports
Class A	1.0.0.1 to 126.255.255.254	Supports 16 million hosts on each of 127 networks.
Class B	128.1.0.1 to 191.255.255.254	Supports 65,000 hosts on each of 16,000 networks.
Class C	192.0.1.1 to 223.255.254.254	Supports 254 hosts on each of 2 million networks.
Class D	224.0.0.0 to 239.255.255.255	Reserved for multicast groups.
Class E	240.0.0.0 to 254.255.255.254	Reserved for future use, or Research and Development Purposes.

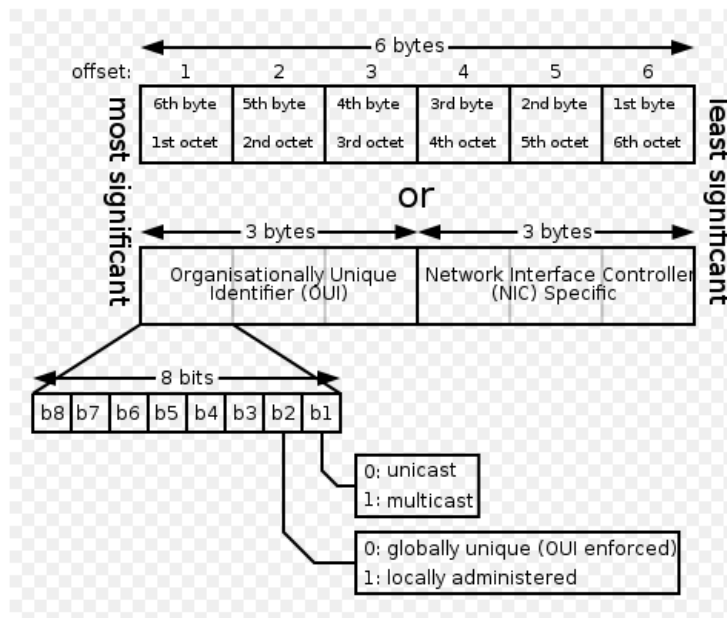

IP multicast address	Description
224.0.0.0	Base address (reserved)
224.0.0.1	The All Hosts multicast group that contains all systems on the same network segment
224.0.0.2	The All Routers multicast group that contains all routers on the same network segment
224.0.0.5	The Open Shortest Path First (OSPF) All SPF Routers address. Used to send Hello packets to all OSPF routers on a network segment
224.0.0.6	The OSPF All D Routers address. Used to send OSPF routing information to OSPF designated routers on a network segment
224.0.0.9	The <u>RIP</u> version 2 group address, used to send routing information using the RIP protocol to all RIP v2-aware routers on a network segment
224.0.0.10	EIGRP group address. Used to send EIGRP routing information to all EIGRP routers on a network segment
224.0.0.13	PIM Version 2 (Protocol Independent Multicast)
224.0.0.18	Virtual Router Redundancy Protocol
224.0.0.19 - 21	IS-IS over IP
224.0.0.22	IGMP Version 3 (Internet Group Management Protocol)
224.0.0.102	Hot Standby Router Protocol Version 2
224.0.0.251	Multicast DNS address
224.0.0.252	Link-local Multicast Name Resolution address
224.0.1.1	Network Time Protocol address
224.0.1.39	Cisco Auto-RP-Announce address

224.0.1.40	Cisco Auto-RP-Discovery address
224.0.1.41	H.323 Gatekeeper discovery address

6.5.6.1 CLI Configuration

Node	Command	Description
enable	show mac-address-table multicast	This command displays the current static/dynamic multicast address entries.
enable	show mac-address-table multicast vlan <1-4094>	This command displays the current static/dynamic multicast address entries with a specific VLAN.
enable	configure terminal	This command changes the node to configure node.
configure	mac-address-table multicast MACADDR vlan <1-4094> ports PORTLIST	This command configures a static multicast entry.
configure	no mac-address-table multicast MACADDR	This command removes a static multicast entry from the address table.

6.5.6.2 Web Configuration

Multicast Address

Static Multicast Address Settings

VLAN ID	MAC Address	Port
1 ▾	<input type="text"/>	<input type="text"/>

Multicast Address Table

VLAN ID	MAC Address	Status	Port	Action
Total Counts: 0				

Parameter	Description
Static Multicast Address Settings	
VLAN ID	Configures the VLAN that you want to configure.
MAC Address	Configures the multicast MAC which will not be aged out. Valid format is hh:hh:hh:hh:hh:hh.
Port	Configures the member port for the multicast address.
Apply	Click Apply to take effect the settings.
Refresh	Click Refresh to begin configuring this screen afresh.

6.6 VLAN

6.6.1 Port Isolation

The port isolation is a port-based virtual LAN feature. It partitions the switching ports into virtual private domains designated on a per port basis. Data switching outside of the port's private domain is not allowed. It will ignore the packets' tag VLAN information.

This feature is a per port setting to configure the egress port(s) for the specific port to forward its received packets. If the CPU port (port 0) is not an egress port for a specific port, the host connected to the specific port cannot manage the Switch.

If you wish to allow two subscriber ports to talk to each other, you must define the egress port for both ports. CPU refers to the Switch management port. By default it forms a VLAN with all Ethernet ports. If it does not form a VLAN with a particular port then the Switch cannot be managed from that port.

Example: If you want to allow port-1 and port-3 to talk to each other, you must configure as below:

```
L2SWITCH(config)#interface 1/0/1
L2SWITCH(config-if)#port-isolation ports 3
L2SWITCH(config-if)#exit
; Allow the port-1 to send its ingress packets to port-3.
```

```
L2SWITCH(config)#interface 1/0/3
L2SWITCH(config-if)#port-isolation ports 1
L2SWITCH(config-if)#exit
; Allow the port-3to send its ingress packets to port-1
```

6.6.1.1 CLI Configuration

Node	Command	Description
enable	show port-isolation	This command displays the current port isolation configurations. “V” indicates the port’s packets can be sent to that port. “-” indicates the port’s packets cannot be sent to that port.
enable	configure terminal	This command changes the node to configure node.
configure	interface IFNAME	This command enters the interface configure node.
interface	port-isolation ports PORTLISTS	This command configures a port or a range of ports to egress traffic from the specific port.
interface	no port-isolation	This command configures all ports to egress traffic from the specific port.

Example:

```
L2SWITCH(config)#interface 1/0/2
L2SWITCH(config-if)#port-isolation ports 3-10
```

6.6.1.2 Web Configuration

Port Isolation

Port Isolation Settings

Port From: 1 To: 1

Egress Port:

Select All Deselect All

2 4 6 8 10 12 0 (CPU)

1 3 5 7 9 11

Port Isolation Status

Port	Egress Port												
	0	1	2	3	4	5	6	7	8	9	10	11	12
1	v	v	v	v	v	v	v	v	v	v	v	v	v
2	v	v	v	v	v	v	v	v	v	v	v	v	v
3	v	v	v	v	v	v	v	v	v	v	v	v	v
4	v	v	v	v	v	v	v	v	v	v	v	v	v
5	v	v	v	v	v	v	v	v	v	v	v	v	v
6	v	v	v	v	v	v	v	v	v	v	v	v	v
7	v	v	v	v	v	v	v	v	v	v	v	v	v
8	v	v	v	v	v	v	v	v	v	v	v	v	v
9	v	v	v	v	v	v	v	v	v	v	v	v	v
10	v	v	v	v	v	v	v	v	v	v	v	v	v
11	v	v	v	v	v	v	v	v	v	v	v	v	v
12	v	v	v	v	v	v	v	v	v	v	v	v	v

Parameter	Description
Port Isolation Settings	
Port	Select a port number to configure its port isolation settings. Select All Ports to configure the port isolation settings for all ports on the Switch.
Egress Port	An egress port is an outgoing port, that is, a port through which a data packet leaves. Selecting a port as an outgoing port means it will communicate with the port currently being configured.
Select All/ Deselect All	Click Select All to mark all ports as egress ports and permit traffic. Click Deselect All to unmark all ports and isolate them. Deselecting all ports means the port being configured cannot communicate with any other port.
Apply	Click Apply to take effect the settings.
Refresh	Click Refresh to begin configuring this screen afresh.

Port Isolation Status

“V” indicates the port’s packets can be sent to that port.
 “-” indicates the port’s packets cannot be sent to that port.

6.6.2 802.1Q VLAN

A virtual LAN, commonly known as a VLAN, is a group of hosts with a common set of requirements that communicate as if they were attached to the Broadcast domain, regardless of their physical location. A VLAN has the same attributes as a physical LAN, but it allows for end stations to be grouped together even if they are not located on the same network switch. Network reconfiguration can be done through software instead of physically relocating devices.

VID- VLAN ID is the identification of the VLAN, which is basically used by the standard 802.1Q. It has 12 bits and allow the identification of 4096 (2^{12}) VLANs. Of the 4096 possible VIDs, a VID of 0 is used to identify priority frames and value 4095 (FFF) is reserved, so the maximum possible VLAN configurations are 4,094.

A tagged VLAN uses an explicit tag (VLAN ID) in the MAC header to identify the VLAN membership of a frame across bridges - they are not confined to the switch on which they were created. The VLANs can be created statically by hand or dynamically through GVRP. The VLAN ID associates a frame with a specific VLAN and provides the information that switches need to process the frame across the network. A tagged frame is four bytes longer than an untagged frame and contains two bytes of TPID (Tag Protocol Identifier, residing within the type/length field of the Ethernet frame) and two bytes of TCI (Tag Control Information, starts after the source address field of the Ethernet frame).

The CFI (Canonical Format Indicator) is a single-bit flag, always set to zero for Ethernet switches. If a frame received at an Ethernet port has a CFI set to 1, then that frame should not be forwarded as it is to an untagged port. The remaining twelve bits define the VLAN ID, giving a possible maximum number of 4,096 VLANs. Note that user priority and VLAN ID are independent of each other. A frame with VID (VLAN Identifier) of null (0) is called a priority frame, meaning that only the priority level is significant and the default VID of the ingress port is given as the VID of the frame. Of the 4096 possible VIDs, a VID of 0 is used to identify priority frames and value 4095 (FFF) is reserved, so the maximum possible VLAN configurations are 4,094.

TPID	User Priority	CFI	VLAN ID
2 bytes	3 bits	1 bit	12 bits

- Forwarding Tagged and Untagged Frames

Each port on the Switch is capable of passing tagged or untagged frames. To forward a frame from an 802.1Q VLAN-aware switch to an 802.1Q VLAN-unaware switch, the Switch first decides where to forward the frame and then strips off the VLAN tag. To forward a frame from an 802.1Q VLAN-unaware switch to an 802.1Q VLAN-aware switch, the Switch first decides where to forward the frame, and then inserts a VLAN tag reflecting the ingress port's default VID. The default PVID is VLAN 1 for all ports, but this can be changed.

A broadcast frame (or a multicast frame for a multicast group that is known by the system) is duplicated only on ports that are members of the VID (except the ingress port itself), thus confining the broadcast to a specific domain.

- 802.1QPort base VLAN

With port-based VLAN membership, the port is assigned to a specific VLAN independent of the user or system attached to the port. This means all users attached to the port should be members of the same VLAN. The network administrator typically performs the VLAN assignment. The port configuration is static and cannot be automatically changed to another VLAN without manual reconfiguration.

As with other VLAN approaches, the packets forwarded using this method do not leak into other VLAN domains on the network. After a port has been assigned to a VLAN, the port cannot send to or receive from devices in another VLAN without the intervention of a Layer 3 device.

The device that is attached to the port likely has no understanding that a VLAN exists. The device simply knows that it is a member of a subnet and that the device should be able to talk to all other members of the subnet by simply sending information to the cable segment. The switch is responsible for identifying that the information came from a specific VLAN and for ensuring that the information gets to all other members of the VLAN. The switch is further responsible for ensuring that ports in a different VLAN do not receive the information.

This approach is quite simple, fast, and easy to manage in that there are no complex lookup tables required for VLAN segmentation. If port-to-VLAN association is done with an application-specific integrated circuit (ASIC), the performance is very good. An ASIC allows the port-to-VLAN mapping to be done at the hardware level.

Default Settings

The default PVID is 1 for all ports.

The default Acceptable Frame is All for all ports.

All ports join in the VLAN 1.

Notice: The maximum VLAN group is 4094.

6.6.2.1 VLAN

6.6.2.1.1 CLI Configuration

Node	Command	Description
enable	show vlan	This command displays all of the VLAN configurations.
enable	show vlan <1-4094>	This command displays the VLAN configurations.
enable	configure terminal	This command changes the node to configure node.
configure	vlan <1~4094>	This command enables a VLAN and enters the

		VLAN node.
configure	no vlan <1~4094>	This command deletes a VLAN.
vlan	show	This command displays the current VLAN configurations.
vlan	name STRING	This command assigns a name for the specific VLAN. The VLAN name should be the combination of the digit or the alphabet or hyphens (-) or underscores (_). The maximum length of the name is 16 characters.
vlan	no name	This command configures the VLAN name to default. Note: The default VLAN name is "VLAN"+vlan-ID, VLAN1, VLAN2,...
vlan	add PORTLISTS	This command adds a port or a range of ports to the VLAN.
vlan	fixed PORTLISTS	This command assigns ports for permanent member of the VLAN.
vlan	no fixed PORTLISTS	This command removes all fixed member from the VLAN.
configure	vlan range VLANLIST	This command configures a range of VLANs.
configure	no vlan range VLANLIST	This command removes a range of VLANs.
vlan-range	add PORTLISTS	This command adds a port or a range of ports to the VLANs.
vlan-range	fixed PORTLISTS	This command assigns ports for permanent member of the VLAN group.
vlan-range	no fixed PORTLISTS	This command removes all fixed member from the VLANs.

6.6.2.1.2 Web Configuration

VLAN

VLAN Settings
Tag Settings
Port Settings

VLAN Settings

VLAN ID	VLAN Name	Member Port
From: <input style="width: 50px;" type="text"/> To: <input style="width: 50px;" type="text"/>	<input style="width: 150px;" type="text"/>	<input style="width: 80px;" type="text"/>
<input type="button" value="Apply"/> <input type="button" value="Refresh"/>		

VLAN List

VLAN ID	VLAN Name	VLAN Status	Member Port	Action
1	VLAN1	Static	1-12	

Parameter	Description
VLAN Settings	
VLAN ID	Enter the VLAN ID for this entry; the valid range is between 1 and 4094.
VLAN Name	Enter a descriptive name for the VLAN for identification purposes. The VLAN name should be the combination of the digit or the alphabet or hyphens (-) or underscores (_). The maximum length of the name is 16 characters.
Member Port	Enter the port numbers you want the Switch to assign to the VLAN as members. You can designate multiple port numbers individually by using a comma (,) and by range with a hyphen (-).
Apply	Click Apply to take effect the settings.
Refresh	Click Refresh to begin configuring this screen afresh.
VLAN List	
VLAN ID	This field displays the index number of the VLAN entry. Click the number to modify the VLAN.
VLAN Name	This field displays the name of the VLAN.
VLAN Status	This field displays the status of the VLAN. Static or Dynamic (802.1QVLAN).
Member Port	This field displays which ports have been assigned as members of the VLAN. This will display None if no ports have been assigned.
Action	Click Delete to remove the VLAN. The VLAN 1 cannot be deleted.

6.6.2.2 Tag Settings

6.6.2.2.1 CLI Configuration

Node	Command	Description
enable	show vlan	This command displays all of the VLAN configurations.
enable	show vlan <1-4094>	This command displays the VLAN configurations.
enable	configure terminal	This command changes the node to configure node.
configure	vlan <1~4094>	This command enables a VLAN and enters the VLAN node.
vlan	show	This command displays the current VLAN configurations.
vlan	add PORTLISTS	This command adds a port or a range of ports to the VLAN.
vlan	tagged PORTLISTS	This command assigns ports for tagged member of the VLAN group. The ports should be one/some of the permanent members of the VLAN.
vlan	no tagged PORTLISTS	This command removes all tagged member from the VLAN.
vlan	Untagged PORTLISTS	This command assigns ports for untagged member of the VLAN group. The ports should be one/some of the permanent members of the VLAN.
vlan	no untagged PORTLISTS	This command removes all untagged member from the VLAN.

Example:

```
L2SWITCH#configure terminal
L2SWITCH(config)#vlan 2
L2SWITCH(config-vlan)#fixed 1-6
L2SWITCH(config-vlan)#tagged 1-3
```

6.6.2.2.2 Web Configuration

VLAN

VLAN Settings
Tag Settings
Port Settings

Tag Settings

VLAN ID From: To:

Tag Port :

Select All Deselect All

2 4 6 8 10 12

1 3 5 7 9 11

Tag Status

VLAN ID	Tag Ports	UnTag Ports
1		1-12

Parameter	Description
Tag Settings	
VLAN ID	Enter the VLAN ID range for port tagging settings; the valid range is between 1 and 4094.
Tag Port	Selecting a port which is a member of the selected VLAN ID will make it a tag port. This means the port will tag all outgoing frames transmitted with the VLAN ID.
Select All	Click Select All to mark all member ports as tag ports.
Deselect All	Click Deselect All to mark all member ports as untag ports.
Apply	Click Apply to take effect the settings.
Refresh	Click Refresh to begin configuring this screen afresh.

6.6.2.3 Port Settings

6.6.2.3.1 CLI Configuration

Node	Command	Description
enable	show vlan	This command displays all of the VLAN configurations.
enable	show vlan <1-4094>	This command displays the VLAN configurations.
enable	configure terminal	This command changes the node to configure node.
configure	interface IFNAME	This command enters the interface configure node.
interface	acceptable frame type (all tagged untagged)	This command configures the acceptable frame type. all - acceptable all frame types. tagged - acceptable tagged frame only. untagged - acceptable untagged frame only.
interface	pvid <1-4094>	This command configures a VLAN ID for the port default VLAN ID.
interface	no pvid	This command configures 1 for the port default VLAN ID.
configure	interface range gigabitethernet1/0/PORTLISTS	This command enters the if-range configure node.
if-range	acceptable frame type (all tagged untagged)	This command configures the acceptable frame type. all - acceptable all frame types. tagged - acceptable tagged frame only. untagged - acceptable untagged frame only.
if-range	pvid <1-4094>	This command configures a VLAN ID for the port default VLAN ID.
if-range	no pvid	This command configures 1 for the port default VLAN ID.

6.6.2.3.2 Web Configuration

VLAN

VLAN Settings
Tag Settings
Port Settings

Port Settings

Port	PVID	Acceptable Frame
From: <input type="text" value="1"/> <input type="text" value="1"/>	<input type="text" value="1"/>	<input type="text" value="All"/>

Port Status

Port	PVID	Acceptable Frame	Port	PVID	Acceptable Frame
1	1	All	2	1	All
3	1	All	4	1	All
5	1	All	6	1	All
7	1	All	8	1	All
9	1	All	10	1	All
11	1	All	12	1	All

Parameter	Description
Port Settings	
Port	Select a port number to configure from the drop-down box. Select All to configure all ports at the same time.
PVID	Select a PVID (Port VLAN ID number) from the drop-down box.
Acceptable Frame	Specify the type of frames allowed on a port. Choices are All , VLAN Untagged Only or VLAN Tagged Only . - Select All from the drop-down list box to accept all untagged or tagged frames on this port. This is the default setting. - Select VLAN Tagged Only to accept only tagged frames on this port. All untagged frames will be dropped. - Select VLAN Untagged Only to accept only untagged frames on this port. All tagged frames will be dropped.
Apply	Click Apply to take effect the settings.
Refresh	Click Refresh to begin configuring this screen afresh.

6.6.3 GARP/GVRP

GARP and GVRP are industry-standard protocols that are described in IEEE 802.1p. GVRP is a GARP application that provides 802.1Q-compliant VLAN pruning and dynamic VLAN creation on 802.1Q trunk ports.

With GVRP, the switch can exchange VLAN configuration information with other GVRP switches, prune unnecessary broadcast and unknown unicast traffic, and dynamically create and manage VLANs on switches that are connected through **802.1Q trunk ports**.

GVRP makes use of GID and GIP, which provide the common state machine descriptions and the common information propagation mechanisms defined for use in GARP-based applications. GVRP prunes trunk links so that only active VLANs will be sent across trunk connections. GVRP expects to hear join messages from the switches before it will add a VLAN to the trunk. GVRP updates and hold timers can be altered. GVRP ports run in various modes to control how they will prune VLANs. GVRP can be configured to dynamically add and manage VLANs to the VLAN database for trunking purposes.

In other words, GVRP allows the propagation of VLAN information from device to device. With GVRP, a single switch is manually configured with all the desired VLANs for the network, and all other switches on the network learn those VLANs dynamically. An end-node can be plugged into any switch and be connected to that end-node's desired VLAN. For end-nodes to make use of GVRP, they need GVRP-aware Network Interface Cards (NICs). The GVRP-aware NIC is configured with the desired VLAN or VLANs, then connected to a GVRP-enabled switch. The NIC communicates with the switch, and VLAN connectivity is established between the NIC and switch.

Registration Mode:

- Normal : The **normal** registration mode allows dynamic creation (if dynamic VLAN creation is enabled), registration, and deregistration of VLANs on the trunk port. Normal mode is the default.
- Forbidden: The **forbidden** registration mode deregisters all VLANs (except VLAN 1) and prevents any further VLAN creation or registration on the trunk port.
- Fixed : The **fixed** registration mode allows manual creation and registration of VLANs, prevents VLAN deregistration, and registers all known VLANs on other ports on the trunk port. (Same as the static VLAN)

GVRP Timer:

Join Timer: Specifies the maximum number of milliseconds the interface waits before sending VLAN advertisements.

Leave Timer: Specifies the number of milliseconds an interface waits after receiving a leave message before the interface leaves the VLAN specified in the message.

Leave-all Timer: Specifies the interval in milliseconds at which Leave All messages are sent on interfaces. Leave-all messages help to maintain current GVRP VLAN membership information in the network.

The value for **leave** must be greater than three times the **join** value (**leave** \geq **join** * 3).

The value for **leave-all** must be greater than the value for **leave** (**leave-all**>**leave**).

Default Settings

The default port Join Time is 20 for all ports.

The default port Leave Time is 60 for all ports.

The default port Leave-all Time is 1000 for all ports.

The default port Hold Time is 10 for all ports.

6.6.3.1 GVRP

6.6.3.1.1 CLI Configuration

Node	Command	Description
enable	show gvrp configuration	This command displays the GVRP configurations.
enable	show gvrp statistics	This command displays the GVRP configurations on a port or all ports.
enable	configure terminal	This command changes the node to configure node.
configure	gvrp (disable enable)	This command disables / enables the GVRP on the switch.
configure	no gvrp configuration	This command set GVRP configuration to its defaults.
configure	interface IFNAME	This command enters the interface configure node.
interface	gvrp (disable enable)	This command disables / enables the GVRP on the specific port.
interface	gvrp registration (normal forbidden)	This command configures the registration mode for the GVRP on the specific port.
interface	no gvrp configuration	This command set GVRP configuration to its defaults for the specific port.

6.6.3.1.2 Web Configuration

GARP VLAN Registration Protocol

GVRP
GARP Timer

GVRP Settings

GVRP State: Disable ▾

Port	State	Registration Mode
From: 1 ▾ To: 1 ▾	Disable ▾	Normal ▾

GVRP Status

Port	State	Registration Mode	Port	State	Registration Mode
1	Disabled	-	2	Disabled	-
3	Disabled	-	4	Disabled	-
5	Disabled	-	6	Disabled	-
7	Disabled	-	8	Disabled	-
9	Disabled	-	10	Disabled	-
11	Disabled	-	12	Disabled	-

Parameter	Description
GARP Settings	
GVRP State	Select Enable to activate GVRP function to exchange VLAN configuration information with other GVRP switches. Select Disable to deactivate the feature.
Port	Select the port that you want to configure the GVRP settings.
State	Select Enable to activate the port GVRP function. Select Disable to deactivate the port GVRP function.
Registration Mode	Select Normal to allows dynamic creation (if dynamic VLAN creation is enabled), registration, and deregistration of VLANs on the trunk port. Select Forbidden to deregister all VLANs (except VLAN 1) and prevents any further VLAN creation or registration on the trunk port.
Apply	Click Apply to take effect the settings.
Refresh	Click Refresh to begin configuring this screen afresh.

6.6.3.2 GARP Timer

6.6.3.2.1 CLI Configuration

Node	Command	Description
enable	show garp timer	This command displays the timers for the GARP.
enable	configure terminal	This command changes the node to configure mode.
configure	interface IFNAME	This command enters the interface configure mode.
interface	garp join-time <1-65535> leave-time <1-65535> leaveall-time <1-65535>	This command configures the join time / leaves time /leave all time for the GARP on the specific port.
interface	no garp time	This command configures the join time / leaves time / leaves all time to default for the GARP on the specific port.

6.6.3.2.2 Web Configuration

GARP VLAN Registration Protocol

GVRP
GARP Timer

GARP Timer Settings

Port	Join Time	Leave Time	Leave All Time
From: <input type="text" value="1"/> To: <input type="text" value="1"/>	<input type="text" value="20"/>	<input type="text" value="60"/>	<input type="text" value="1000"/>

2*Join Time < Leave Time < Leave All Time
Time unit:(centi-sec)

GARP Timer Status

Port	Join Time	Hold Time	Leave Time	Leave All Time
1	20	10	60	1000
2	20	10	60	1000
3	20	10	60	1000
4	20	10	60	1000
5	20	10	60	1000
6	20	10	60	1000
7	20	10	60	1000
8	20	10	60	1000
9	20	10	60	1000
10	20	10	60	1000
11	20	10	60	1000
12	20	10	60	1000

Parameter	Description
-----------	-------------

GARP Timer Settings	
Join Time	Specifies the maximum number of milliseconds the interface waits before sending VLAN advertisements.
Leave Time	Specifies the number of milliseconds an interface waits after receiving a leave message before the interface leaves the VLAN specified in the message.
Leave-all Time	Specifies the interval in milliseconds at which Leave All messages are sent on interfaces. Leave All messages help to maintain current GVRP VLAN membership information in the network.
Apply	Click Apply to take effect the settings.
Refresh	Click Refresh to begin configuring this screen afresh.

6.6.4 IP Subnet VLAN

IP subnet based VLANs enable the user to categorize the group of traffics into logical VLANs based on the source IP addresses and the subnet masks of packets. After receiving an untagged packet from a port, the switch checks its source IP address and the IP subnet from where is came from. After the checking has done, the switch forwards the packet in the corresponding VLAN. If no IP subnet classification can be made, the packet is followed to the normal VLAN classification methods of the switch. The significant benefit of using subnet based VLANs is that the priority can be divided and integrated based on which VLAN the traffic belongs to.

Notices: The 802.1Q port base VLAN should be created first in order for the packet to be switched.

6.6.4.1 CLI Configuration

Node	Command	Description
enable	show ip-subnet-vlan	This command displays the all of the IP subnet vlan configurations.
enable	configure terminal	This command changes the node to configure node.
configure	ip-subnet-vlan ip IPADDR mask IPADDR vlan <1-4094> priority <0-7>	This command creates an IP subnet vlan entry with the IP address, subnet mask, vlan and priority.
configure	no ip-subnet-vlan ip IPADDR	This command deletes an IP subnet vlan entry.
configure	no ip-subnet-vlan all	This command deletes all of the IP subnet vlan entries.

Example: If you want to let hosts group 192.168.203.xxx to vlan 2 with priority 3. You can configure as below:

```
L2SWITCH(config)#ip-subnet-vlan ip 192.168.203.1 mask 255.255.255.0 vlan 2 priority 3
```

Display current IP subnet vlan configurations:

```
L2SWITCH#show ip-subnet-vlan
```

IP Address	Subnet Mask	VLAN	Priority
-----	-----	-----	-----
192.168.203.1	255.255.255.0	2	3

Total Entries: 1

6.6.4.2 Web Configuration

IP Subnet VLAN

IP Subnet VLAN Settings

IP Address	Subnet Mask	VLAN	Priority
<input style="width: 90%;" type="text"/>	<input style="width: 90%;" type="text"/>	<input style="width: 90%;" type="text"/>	0 ▾
<input type="button" value="Apply"/> <input type="button" value="Refresh"/>			

IP Subnet VLAN Table

Index	IP Address	Subnet Mask	VLAN	Priority	Action
					Total Counts: 0

Parameter	Description
IP Subnet VLAN Settings	
IP Address	Configures the IP address.
Subnet Mask	Configures the IP subnet mask.
VLAN	Configures the vlan.
Priority	Configures the priority.
Apply	Click Apply to take effect the settings.
Refresh	Click Refresh to begin configuring this screen afresh.
IP Subnet VLAN Table	
Action	Clicks Delete to delete this rule.
Total Counts	It displays the total entry of the IP subnet vlan.

6.6.5 MAC-based VLAN

The MAC base VLAN allows users to create VLAN with MAC address. The MAC address can be the leading three or more bytes of the MAC address. For example, 00:01:02 or 00:03:04:05 or 00:01:02:03:04:05.

When the Switch receives packets, it will compare MAC-based VLAN configures. If the SA is matched the MAC-based VLAN configures, the Switch replace the VLAN with user configured and them forward them.

For example:

Configurations: 00:01:02, VLAN=23, Priority=2.

The packets with SA=00:01:02:xx:xx:xx will be forwarded to VLAN 22 member ports.

Notices: The 802.1Q port base VLAN should be created first.

6.6.5.1 CLI Configuration

Node	Command	Description
enable	show mac-vlan	This command displays the all of the mac-vlan configurations.
enable	configure terminal	This command changes the node to configure node.
configure	mac-vlan STRINGS vlan <1-4094> priority <0-7>	This command creates a mac-vlan entry with the leading three or more bytes of mac address and the VLAN and the priority.
configure	no mac-vlan entry STRINGS	This command deletes a mac-vlan entry.
configure	no mac-vlan all	This command deletes all of the mac-vlan entries.

Example:

```
L2SWITCH(config)#mac-vlan 00:01:02:03 vlan 111 priority 1
L2SWITCH(config)#mac-vlan 00:01:02:22:04 vlan 121 priority 1
L2SWITCH(config)#mac-vlan 00:01:22:22:04:05 vlan 221 priority 1
```

6.6.5.2 Web Configuration

MAC VLAN

MAC VLAN Settings

MAC Address	VLAN	Priority
<input style="width: 90%;" type="text"/>	<input style="width: 90%;" type="text"/> (1~4094)	<input style="width: 90%;" type="text" value="0"/> ▼

Ex: HH:HH:HH will only filter 3 bytes of source mac address.
 HH:HH:HH:HH:HH will only filter 5 bytes of source mac address.
 HH:HH:HH:HH:HH:HH will filter all bytes of source mac address.

MAC VLAN Table

Index	MAC Address	VLAN	Priority	Action

Parameter	Description
MAC VLAN Settings	
MAC Address	Configures the leading three or more bytes of the MAC address.
VLAN	Configures the VLAN.
Priority	Configures the 802.1Q priority.
Apply	Click Apply to take effect the settings.
Refresh	Click Refresh to begin configuring this screen afresh.
MAC VLAN Table	
Action	Click Delete to delete the MAC VLAN profile.

6.6.6 Protocol-based VLAN

The Protocol based VLAN allows users to create VLAN with packet frame type. The packet frame type can be one of the three frame types: EthernetII, Non-LLC-SNAP and LLC-SNAP. If configuring the EthernetII frame type, the configuration will be more detail with the Ethernet type.

When the user configures the protocol VLAN as LLC-SNAP, VLAN:22, ports list: 1-3. If the Switch receives packets with LLC-SNAP frame type from port 1 to 3, the packets' VLAN will be replaced with VLAN 22 and be forwarded to VLAN 22 member ports.

Notices: The 802.1Q port base VLAN should be created first.

6.6.6.1 CLI Configuration

Node	Command	Description
enable	show protocol-vlan	This command displays the all of the protocol-vlan configurations.
enable	configure terminal	This command changes the node to configure node.
configure	protocol-vlan frame-type ethernetII ether-type STRINGS vlan <1-4094> ports PORTLISTS	This command creates a protocol-vlan entry with ethernetII frame type.
configure	protocol-vlan frame-type nonLLC-SNAP vlan <1-4094> ports PORTLISTS	This command creates a protocol-vlan entry with nonLLC-SNAP frame type.
configure	protocol-vlan frame-type LLC-SNAP vlan <1-4094> ports PORTLISTS	This command creates a protocol-vlan entry with LLC-SNAP frame type.
configure	no protocol-vlan frame-type ethernetII ether-type STRINGS vlan <1-4094>	This command deletes a protocol-vlan entry with ethernetII frame type.
configure	no protocol-vlan frame-type nonLLC-SNAP vlan <1-4094>	This command deletes a protocol-vlan entry with nonLLC-SNAP frame type and vlan.
configure	no protocol-vlan frame-type LLC-SNAP vlan <1-4094>	This command deletes a protocol-vlan entry with LLC-SNAP frame type and vlan.
configure	no protocol-vlan all	This command deletes all of the protocol-vlan entries.

Example:

```
L2SWITCH(config)#protocol-vlan frame-type LLC-SNAP vlan 12 ports 1-2
L2SWITCH(config)#protocol-vlan frame-type nonLLC-SNAP vlan 13 ports 3-4
L2SWITCH(config)#protocol-vlan frame-type ethernetII ether-type 0800 vlan 14 ports 1-2
```

6.6.6.2 Web Configuration

Protocol VLAN

Protocol VLAN Settings

Frame Type	Ethernet Type	VLAN	Port List
EthernetII <input type="button" value="v"/>	<input type="text"/>	<input type="text"/>	<input type="text"/>

Protocol VLAN Table

Index	Frame Type	Ethernet Type	VLAN	Port List	Action
-------	------------	---------------	------	-----------	--------

Parameter	Description
Protocol VLAN Settings	
Frame Type	Select one of three frame types, “EthernetIU” and “NonLLC-SNAP” and “LLC-SNAP”.
Ethernet type	Input the Ethernet type for the EthernetII frame type.
VLAN	Configure the VLAN ID.
Port List	Configure the member ports.
Apply	Click Apply to take effect the settings.
Refresh	Click Refresh to begin configuring this screen afresh.
Protocol VLAN Table	
Action	Click Delete to delete the protocol VLAN profile.

6.6.7 Q-in-Q VLAN (VLAN Stacking)

Q-in-Q tunneling is also known as VLAN stacking. Both of them use 802.1q double tagging technology. Q-in-Q is required by ISPs (Internet Service Provider) that need Transparent LAN services (TLS), and the service provider has their own set of VLAN, independent of customer VLANs. Typically, each service provider VLAN interconnects a group of sites belonging to a customer. However, a service provider VLAN could also be shared by a set of customers sharing the same end points and quality of service requirements of the VLAN. Double tagging is considered to be a relatively simpler way of implementing transparent LAN. This is accomplished by encapsulating Ethernet Frame. A second or outer VLAN tag is inserted in Ethernet frames sent over the ingress PE (Provider Edge). This VLAN tag corresponds to the VLAN of the Service Provider (SP). When the frame reaches the destination PE, the SP VLAN is stripped off. The DA of the encapsulated frame and the VLAN ID are used to take further L2 decisions, similar to an Ethernet frame arriving from a physical Ethernet port. The SP VLAN tag determines the VPLS (Virtual Private LAN Service) membership. Double tagging aggregates multiple VLANs within another VLAN and provides a private, dedicated Ethernet connection between customers to reach their subnet transparently across multiple networks. Thus service providers can create their own VLANs without interfering with customer VLANs by using double tagging. This allows them to connect customers to ISPs and ASPs (Application Service Provider).

The ports that are connected to the service provider VLANs are called tunnel ports, and the ports that are connected to the customer VLANs are called access (subscriber/customer) ports. When a port is configured as tunnel port, all the outgoing packets on this port will be sent out with SPVLAN (SPVID and 1p priority) tag. The incoming packet can have two tags (SPVLAN + CVLAN), one tag (SPVLAN or CVLAN), or no tag. In all cases, the packet is sent out with a SPVLAN tag. When a port is configured as an access port, the incoming traffic can have only a CVLAN (CVID and 1p priority) tag or no tag. Hence, all the packets that are being sent out of access ports will be untagged or single tagged (CVLAN). When a port is configured as a normal port, it will ignore the frames with double tagging.

Double Tagging Format

A VLAN tag (service provider VLAN stacking or customer IEEE 802.1Q) consists of the following three fields.

TPID	Priority	VID
------	----------	-----

TPID (Tag Protocol Identifier) is a standard Ethernet type code identifying the frame and indicates that whether the frame carries IEEE 802.1Q tag information. The value of this field is 0x8100 as defined in IEEE 802.1Q. Other vendors may use a different value, such as 0x9100.

Tunnel TPID is the VLAN stacking tag type the Switch adds to the outgoing frames sent through a Tunnel Port of the service provider's edge devices

Priority refers to the IEEE 802.1p standard that allows the service provider to prioritize traffic based on the class of service (CoS) the customer has paid for. "0" is the lowest priority level and "7" is the highest.

VID is the VLAN ID. **SP VID** is the VID for the second or outer (service provider’s) VLAN tag. **CVID** is the VID for the first or inner (Customer’s) VLAN tag.

The frame formats for an untagged Ethernet frame; a single-tagged 802.1Q frame (customer) and a “double-tagged” 802.1Q frame (service provider) are shown as following.

untagged frame	DA	SA	Len or Etype	Data	FCS						
single-tagged frame	DA	SA	TPID	P	VID	Len or Etype	Data	FCS			
double-tagged frame	DA	SA	Tunnel TPID	P	VID	TPID	P	VID	Len or Etype	Data	FCS

DA: Destination Address

SA: Source Address

Tunnel TPID: Tag Protocol Identifier added on a tunnel port

P: 802.1p priority

VID: VLAN ID

Len or Etype: Length or Ethernet frame type

Data: Frame data

FCS: Frame Check Sequence

VLAN Stacking Port Roles

Each port can have three VLAN stacking “roles”, Normal, Access Port and Tunnel Port.

- ✓ Select **Normal** for “regular” (non-VLAN stacking) IEEE 802.1Q frame switching.
- ✓ Select **Access Port** for ingress ports on the service provider's edge devices. The incoming frame is treated as "untagged", so a second VLAN tag (outer VLAN tag) can be added.
- ✓ Select **Tunnel Port** for egress ports at the edge of the service provider's network. All VLANs belonging to a customer can be aggregated into a single service provider's VLAN (using the outer VLAN tag defined by SP VID).

NOTE: In order to have the double tagged frames switching correctly, user has to configure a service provider’s VLAN (SPVLAN) on the Q-in-Q switch. Then, the double tagged frames can be switched according to the SP VID. The SPVLAN should include all the related Tunnel and Access ports. Also, user has to configure the Tunnel ports as tagged ports and the Access ports as untagged ports.

Port-based Q-in-Q

Q-in-Q encapsulation is to convert a single tagged 802.1Q packet into a double tagged Q-in-Q packet. The Q-in-Q encapsulation can be based on port or traffic. Port-based Q-in-Q is to encapsulate all the packets incoming to a port with the same SPVID outer tag. The mode is more inflexible.

In the following example figure, both **X** and **Y** are Service Provider’s Network (SPN) customers with VPN tunnels between their head offices and branch offices respectively. Both have an

identical VLAN tag for their VLAN group. The service provider can separate these two VLANs within its network by adding tag **100** to distinguish customer **X** and tag **200** to distinguish customer **Y** at edge device A and then stripping those tags at edge device B as the data frames leave the network.

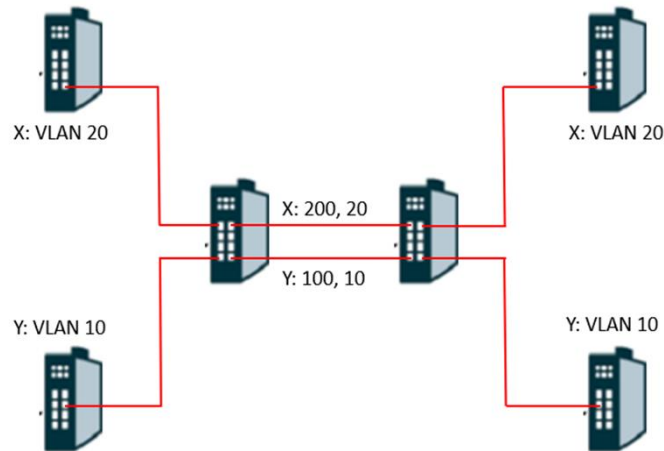

This example shows how to configure switch A with ports 1 on the Switch to tag incoming frames with the service provider's VID of 200 (ports are connected to customer X network) and configure port 7 to service provider's VID of 100 (ports are connected to customer Y network). This example also shows how to set the priority for port 1 to 3 and port 7 to 4.

```
L2SWITCH(config)# vlan-stacking port-based
L2SWITCH(config)# vlan-stacking tpid-table index 2 value 88a8
L2SWITCH(config)# vlan 10
L2SWITCH(config-vlan)# fixed 5,6
L2SWITCH(config-vlan)# tagged 5
L2SWITCH(config-vlan)# exit
L2SWITCH(config)# vlan 100
L2SWITCH(config-vlan)# fixed 5,6
L2SWITCH(config-vlan)# tagged 6
L2SWITCH(config-vlan)# exit
L2SWITCH(config)# vlan 20
L2SWITCH(config-vlan)# fixed 1,2
L2SWITCH(config-vlan)# tagged 1
L2SWITCH(config-vlan)# exit
L2SWITCH(config)# vlan 200
L2SWITCH(config-vlan)# fixed 1,2
L2SWITCH(config-vlan)# tagged 2
L2SWITCH(config-vlan)# exit
L2SWITCH(config)# interface gigaethernet1/0/1
L2SWITCH(config-if)# vlan-stacking port-based role access
L2SWITCH(config-if)# vlan-stacking spvid 200
L2SWITCH(config-if)# vlan-stacking priority 3
```

```
L2SWITCH(config)# interface gigabitEthernet1/0/2
L2SWITCH(config-if)# vlan-stacking port-based role tunnel
L2SWITCH(config-if)# vlan-stacking tunnel-tpid index 2
L2SWITCH(config)# interface gigabitEthernet1/0/5
L2SWITCH(config-if)# vlan-stacking port-based role access
L2SWITCH(config-if)# vlan-stacking spvid 100
L2SWITCH(config-if)# vlan-stacking priority 4
L2SWITCH(config)# interface gigabitEthernet1/0/6
L2SWITCH(config-if)# vlan-stacking port-based role tunnel
L2SWITCH(config-if)# vlan-stacking tunnel-tpid index 2
L2SWITCH(config-if)# exit
L2SWITCH(config)# exit
L2SWITCH# show vlan-stacking
L2SWITCH# show vlan-stacking tpid-table
L2SWITCH# show vlan-stacking port-based-qinq
```

Selective Q-in-Q

The traffic based Q-in-Q is also called Selective Q-in-Q. Selective Q-in-Q allows the Switch to add different outer VLAN tags to the incoming frames received on one port according to their inner VLAN tags. In the Selective Q-in-Q mode, switch performs traffic classification for the traffic incoming to a port based on the VLAN ID. When a user uses different VLAN IDs for different services, traffic can be classified according to the VLAN ID. For example, the VLAN ID 20 for surfing on the internet by PC, VLAN ID 30 for IPTV and VLAN ID 40 for VIP customers. After receiving user data, the switch labels the traffic of surfing on the Internet by PC with 500 as a SPVID outer tag, IPTV with 600, and VIP customers with 700.

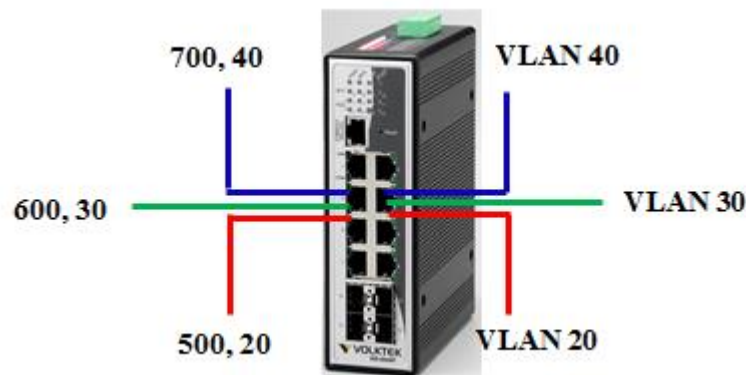

This following example shows how to configure ports 3 on the Switch to tag incoming frames with the different service provider's VID and priority.

```
L2SWITCH(config)# vlan-stacking selective
L2SWITCH(config)# vlan-stacking tpid-table index 6 value 9100
L2SWITCH(config)# vlan 20
L2SWITCH(config-vlan)# fixed 3,4
L2SWITCH(config-vlan)# tagged 3
L2SWITCH(config-vlan)# exit
L2SWITCH(config)# vlan 30
```

```
L2SWITCH(config-vlan)# fixed 3,4
L2SWITCH(config-vlan)# tagged 3
L2SWITCH(config-vlan)# exit
L2SWITCH(config)# vlan 40
L2SWITCH(config-vlan)# fixed 3,4
L2SWITCH(config-vlan)# tagged 3
L2SWITCH(config-vlan)# exit
L2SWITCH(config)# vlan 500
L2SWITCH(config-vlan)# fixed 3,4
L2SWITCH(config-vlan)# tagged 4
L2SWITCH(config-vlan)# exit
L2SWITCH(config)# vlan 600
L2SWITCH(config-vlan)# fixed 3,4
L2SWITCH(config-vlan)# tagged 4
L2SWITCH(config-vlan)# exit
L2SWITCH(config)# vlan 700
L2SWITCH(config-vlan)# fixed 3,4
L2SWITCH(config-vlan)# tagged 4
L2SWITCH(config-vlan)# exit
L2SWITCH(config)# vlan-stacking selective-qinq rule1
L2SWITCH(config-qinq)# cvids 20
L2SWITCH(config-qinq)# priority 2
L2SWITCH(config-qinq)# spvid 500
L2SWITCH(config-qinq)# access-ports 3
L2SWITCH(config-qinq)# tunnel-ports 4
L2SWITCH(config-qinq)# active
L2SWITCH(config-qinq)# show
L2SWITCH(config-qinq)# exit
L2SWITCH(config)# vlan-stacking selective-qinq rule2
L2SWITCH(config-qinq)# cvids 30
L2SWITCH(config-qinq)# priority 5
L2SWITCH(config-qinq)# spvid 600
L2SWITCH(config-qinq)# access-ports 3
L2SWITCH(config-qinq)# tunnel-ports 4
L2SWITCH(config-qinq)# active
L2SWITCH(config-qinq)# show
L2SWITCH(config-qinq)# exit
L2SWITCH(config)# vlan-stacking selective-qinq rule3
L2SWITCH(config-qinq)# cvids 40
L2SWITCH(config-qinq)# priority 7
L2SWITCH(config-qinq)# spvid 700
L2SWITCH(config-qinq)# access-ports 3
L2SWITCH(config-qinq)# tunnel-ports 4
L2SWITCH(config-qinq)# active
L2SWITCH(config-qinq)# show
L2SWITCH(config-qinq)# exit
L2SWITCH(config)# interface interface 1/0/4
```

```
L2SWITCH(config-if)# vlan-stacking tunnel-tpid index 6
L2SWITCH(config-if)# exit
L2SWITCH(config)# exit
L2SWITCH# show vlan-stacking
L2SWITCH# show vlan-stacking tpid-table
L2SWITCH# show vlan-stacking selective-qinq
```

Default Setting: VLAN Stacking is disabled.

6.6.7.1 VLAN Stacking

6.6.7.1.1 CLI Configuration

Node	Command	Description
enable	show vlan-stacking	This command displays the current vlan-stacking type.
enable	show vlan-stacking tpid-inform	This command displays the TPID configurations.
enable	configure terminal	This command changes the node to configure node.
configure	vlan-stacking (disable port-based selective)	This command disable the vlan stacking or enable the vlan-stacking with port-based or selective on the switch.
configure	vlan-stacking tpid-table index <2-6> value STRINGS	This command configures TPID table.
configure	interface IFNAME	This command enters the interface configure node.
interface	vlan-stacking tunnel-tpid index <1-6>	This command sets TPID for a Q-in-Q tunnel port.
configure	interface range gigabitethernet1/0/PORTLISTS	This command enters the if-range configure node.
if-range	vlan-stacking tunnel-tpid index <1-6>	This command sets TPID for a Q-in-Q tunnel port.

6.6.7.1.2 Web Configuration

Q-in-Q

VLAN Stacking
Port-based Q-in-Q
Selective Q-in-Q

VLAN Stacking Settings

Action Disable ▾

Tunnel TPID Index	TPID
1 (Default) ▾	<input style="width: 80%;" type="text" value="8100"/> (0000~ffff)
Port	Tunnel TPID Index
From: 1 ▾ To: 1 ▾	1 (Default) ▾

VLAN Stacking Status

Tunnel TPID Index	TPID
1	8100
2	8100
3	8100
4	8100
5	8100
6	8100

Port	Tunnel TPID Index (TPID)	Port	Tunnel TPID Index (TPID)
1	1 (8100)	2	1 (8100)
3	1 (8100)	4	1 (8100)
5	1 (8100)	6	1 (8100)
7	1 (8100)	8	1 (8100)
9	1 (8100)	10	1 (8100)
11	1 (8100)	12	1 (8100)

Parameter	Description
VLAN Stacking Settings	
Action	Select one of the three modes, Disable or Port-Based or Selective for the VLAN stacking.
Configures the TPID Table: The TPID table has 6 entries.	
Tunnel TPID Index	Selects the table index.
Tunnel TPID Index	Selects the table index.
Configures the Port TPID:	
Port	Selects a port or a range of ports which you want to configure.

Tunnel TPID Index	Configures the index of the TPID Table for the specific ports.
Apply	Click Apply to take effect the settings.
Refresh	Click Refresh to begin configuring this screen afresh.
Action	Click Delete to delete the MAC VLAN profile.

6.6.7.2 Port-Based Q-in-Q

6.6.7.2.1 CLI Configuration

Node	Command	Description
enable	show vlan-stacking portbased-qinq	This command displays the port-based q-in-Q configurations.
enable	configure terminal	This command changes the node to configure node.
configure	interface IFNAME	This command enters the interface configure node.
interface	vlan-stacking port-based priority <0~7>	This command sets the priority in port based Q-in-Q.
interface	vlan-stacking port-based role (tunnel access normal)	This command sets VLAN stacking port role.
interface	vlan-stacking port-based spvid <1~4096>	This command sets the service provider's VID of the specified port.
interface	vlan-stacking tunnel-tpid index <1-6>	This command sets TPID for a Q-in-Q tunnel port.
configure	interface range gigabitethernet1/0/PORTLISTS	This command enters the if-range configure node.
if-range	vlan-stacking port-based priority <0~7>	This command sets the priority in port based Q-in-Q.
if-range	vlan-stacking port-based role (tunnel access normal)	This command sets VLAN stacking port role.
if-range	vlan-stacking port-based spvid <1~4096>	This command sets the service provider's VID of the specified port.
if-range	vlan-stacking tunnel-tpid index <1-6>	This command sets TPID for a Q-in-Q tunnel port.

6.6.7.2.2 Web Configuration

Q-in-Q

VLAN Stacking
Port-based Q-in-Q
Selective Q-in-Q

Port-based Q-in-Q Settings

Port	Role	SPVID	Priority
From: <input type="text" value="1"/> To: <input type="text" value="1"/>	<input type="text" value="Normal"/>	<input type="text" value="1"/> (1~4094)	<input type="text" value="0"/>

Port-based Q-in-Q Status

Port	Role	SPVID	Priority	Port	Role	SPVID	Priority
1	Normal	1	0	2	Normal	1	0
3	Normal	1	0	4	Normal	1	0
5	Normal	1	0	6	Normal	1	0
7	Normal	1	0	8	Normal	1	0
9	Normal	1	0	10	Normal	1	0
11	Normal	1	0	12	Normal	1	0

Parameter	Description
Port-based Q-in-Q Settings	
Port	Selects a port or a range of ports which you want to configure.
Role	Selects one of the three roles, Normal and Access and Tunnel , for the specific ports.
SPVID	Configures the service provider's VLAN.
Priority	Configures the priority for the specific ports.
Apply	Click Apply to take effect the settings.
Refresh	Click Refresh to begin configuring this screen afresh.

6.6.7.3 Selective Q-in-Q

6.6.7.3.1 CLI Configuration

Node	Command	Description
enable	show vlan-stacking selective-qinq	This command displays the selective Q-in-Q configurations.
enable	configure terminal	This command changes the node to configure node.
configure	vlan-stacking (disable port-based selective)	This command disables the vlan stacking or enables the vlan-stacking with port-based or selective on the switch.
configure	vlan-stacking selective-qinq STRINGS	This command creates a selective Q-in-Q profile with the name.
configure	no vlan-stacking selective-qinq STRINGS	This command removes the selective Q-in-Q profile with the name.
qinq	active	This command enables the selective Q-in-Q profile.
qinq	inactive	This command disables the selective Q-in-Q profile.
qinq	cvid <1-4094>	This command specifies the customer's VLAN range on the incoming packets.
qinq	spvid <1-4094>	This command sets the service provider's VLAN ID for outgoing packets in selective Q-in-Q.
qinq	priority <0-7>	This command sets priority in selective Q-in-Q.
qinq	access-ports PORTLISTS	This command specifies the access ports to apply the rule.
qinq	tunnel-ports PORTLISTS	This command specifies the tunnel ports to apply the rule.
qinq	end	The command exits the CLI Q-in-Q node and enters the CLI enable node.
qinq	exit	The command exits the CLI Q-in-Q node and enter the CLI configure node.
qinq	show	The command shows the current selective Q-in-Q profile configurations.

6.6.7.3.2 Web Configuration

Q-in-Q

VLAN Stacking
Port-based Q-in-Q
Selective Q-in-Q

Selective Q-in-Q Settings

Name	<input type="text"/>
Access Ports	<input type="text"/> (ex. 1,3,5-6)
Tunnel Ports	<input type="text"/> (ex. 1,3,5-6)
CVID	<input type="text"/> (Range: 1~4094)
SPVID	<input type="text"/> (Range: 1~4094)
Priority	<input type="text" value="0"/>
Action	<input type="text" value="Disable"/>

Selective Q-in-Q Status

No.	Name	Access Ports	Tunnel Ports	CVID	SPVID	Priority	Action	Delete
-----	------	--------------	--------------	------	-------	----------	--------	--------

Parameter	Description
Selective Q-in-Q Settings	
Name	Configures the selective Q-in-Q profile name.
Access Ports	Configures a port or a range of ports for the access ports.
Tunnel Ports	Configures a port or a range of ports for the tunnel ports.
CVID	Configures a customer's VLAN.
SPVID	Configures a service provider's VLAN.
Priority	Configures an 802.1Q priority for the profile.
Action	Enables / Disables the profile.
Apply	Click Apply to take effect the settings.
Refresh	Click Refresh to begin configuring this screen afresh.
Selective Q-in-Q Status	
Action	Clicks Delete to delete this Selective Q-in-Q rule.

6.6.8 VLAN Translation

VLAN Translation is a simple VLAN swapping on service provider network.

When connecting a large number of networks at service provider, VLAN overlap is a major issue as customer 'A' and customer 'B' may use same VLAN tag. Here VLAN translation will be used to prevent overlaps.

VLAN translation will also be used for joining the segments in large networks also. It is a simple 1 to 1 mapping of VLANs, It will create the VLAN translation by creating policies. The ingress VLAN translation is port based and egress VLAN is global.

We can enable ingress VLAN translation as source port based and egress VLAN translation as global. There are up to 32 rules for the vlan translation, including egress and ingress.

6.6.8.1 CLI Configuration

Node	Command	Description
enable	show vlan-translation	This command displays the vlan translation configuration.
enable	configure terminal	This command changes the node to configure node.
configure	vlan-translation egress old-vlan <1-4094> new-vlan <1-4094> priority <0-7>	This command configures the egress vlan translation configuration for all ports.
configure	vlan-translation ingress port PORT_ID old-vlan <1-4094> new-vlan <1-4094> priority <0-7>	This command configures the vlan translation configuration by port.
configure	no vlan-translation port PORT_ID old-vlan <1-4094>	This command resets the vlan translation configuration by port.
configure	no vlan-translation all	This command resets all of the vlan translation configurations, including egress and ingress configurations.
configure	no vlan-translation egress all	This command resets all of the egress vlan translation configurations.
configure	no vlan-translation egress old-vlan <1-4094>	This command resets specific egress vlan translation configurations.
configure	no vlan-translation ingress port PORT_ID old_vlan <1-4094>	This command resets specific ingress vlan translation configurations.

6.6.8.2 Web Configuration

VLAN Translation

VLAN Translation Settings

VLAN Translation

Port From: To:

Priority

Mapping Vlan

Translated Vlan

VLAN Translation Status

Mode	Port	Mapping Vlan	Translated Vlan	Priority	Action
------	------	--------------	-----------------	----------	--------

Parameter	Description
Vlan Translation Configurations	
Vlan Translation	Select “Ingress” or “Egress” which you want to create the type of vlan translation.
Port	Selects a port or a range of ports for the vlan translation rule.
Priority	Configures a new priority for the vlan translation rule.
Old Vlan	Configures the vlan for the old vlan in the vlan translation rule.
New Vlan	Configures the vlan for the new vlan in the vlan translation rule.
Apply	Click Apply to take effect the settings.
Refresh	Click Refresh to begin configuring this screen afresh.
Vlan Translation Status	
Action	Clicks Delete to delete this vlan translation rule.

6.7 DHCP Options

6.7.1 Option 66 and 67

The Dynamic Host Configuration Protocol (DHCP) is used by device for requesting Internet Protocol parameters, such as an IP address from a network server. The protocol operates based on the client-server model.

When the Switch connects to a network, its DHCP client software in the operating system sends a broadcast query requesting necessary information like IP address. Any DHCP server on the network may service the request. The DHCP server manages a pool of IP addresses and information about client configuration parameters such as default gateway, domain name, the name servers, and time servers, and “DHCP option 66 and 67”.

DHCP option 66 is used to identify a TFTP server when the “TFTP server name” field in the DHCP header has been used for DHCP options. DHCP option 67 is used to identify a TFTP server when the “file name” field in the DHCP header has been used for DHCP options. If DHCP server supplies “DHCP option 66 and 67” then the user can set it. When the switch connects to a network, the switch will get DHCP option 66 and 67’s information from DHCP sever. The user can put the configure file on the TFTP server. The Switch will download configure file from TFTP server automatically and it will take effect the configuration file immediately.

The procedures to use the DHCP option 66 and 67

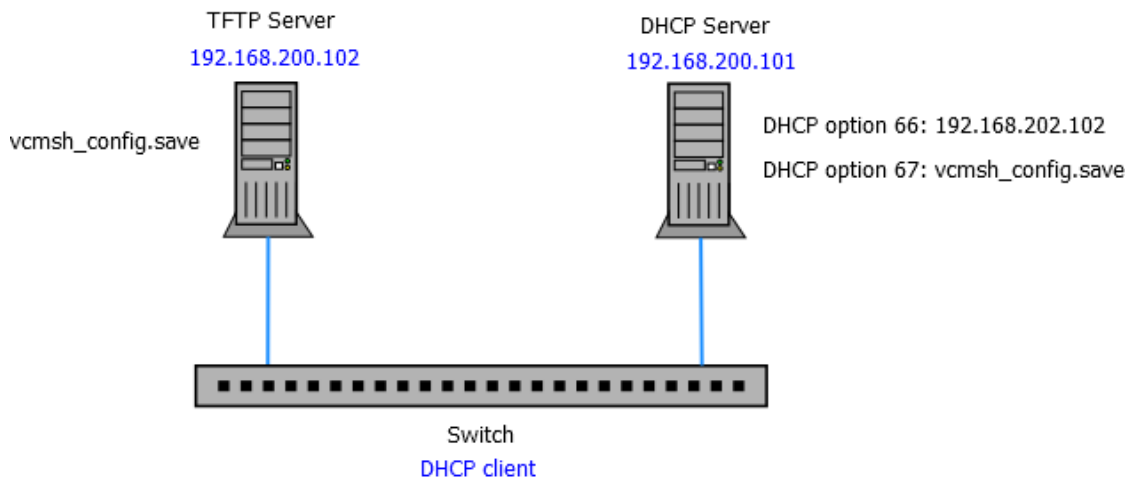

- ✓ Set DHCP option 66 and 67’s information on the DHCP server as below:
DHCP option 66: 192.168.202.102
DHCP option 67: vcmsh_config.save
- ✓ Put configuration file “vcmesh_config.save” in TFTP server.
- ✓ Enable DHCP option 66 and 67 on the Switch.
- ✓ Enable DHCP client on the Switch.

- ✓ When the Switch gets an IP from DHCP server, the DHCP server also gives the option 66's and 67's information to the Switch.
- ✓ When the Switch gets the option 66 and 67 information, it downloads the configuration file from TFTP server automatically.
- ✓ The Switch will take effect the configuration file immediately.
- ✓ If the configuration file has an auto-back command, the Switch backups the current system configuration to the TFTP server automatically.

Notice: The auto-backup command should be the last command in the configuration file.

6.7.1.1 CLI Configuration

Node	Command	Description
enable	show dhcp-options	This command displays the configurations and status for the DHCP option 66 and 67.
enable	configure terminal	This command changes the node to configure node.
configure	dhcp-options option_66_67 (disable enable)	This command disables / enables the DHCP option 66 and 67 on the Switch.
configure	dhcp-options option_66_67 auto-backup	This command uploads the current configurations to TFTP server. The file name is vcmsh_config_MODEL-NAME_MAC if you didn't specify a filename for it.
configure	dhcp-options option_66_67 auto-backupfile FILENAME	This command configures a filename for the auto-backup function.

6.7.1.2 Web Configuration

DHCP Options

Option 66 & 67
Option 82

Option 66 & 67 Settings

State	Disable ▾
TFTP IP	0.0.0.0
TFTP File Name	None

Parameter	Description
DHCP Option 66 & 67 Settings	
State	Select this option to enable / disable the DHCP option 66 and 67 on the Switch.
TFTP IP	The TFTP server's IP address gotten from the DHCP option 66.

TFTP File Name	The configuration filename gotten from the DHCP option 67.
Apply	Click Apply to take effect the settings.
Refresh	Click Refresh to begin configuring this screen afresh.

6.7.2 DHCP Option 82

DHCP Option 82 is the “DHCP Relay Agent Information Option”. Option 82 was designed to allow a DHCP Relay Agent to insert circuit specific information into a request that is being forwarded to a DHCP server. Specifically the option works by setting two sub-options: Circuit ID and Remote ID.

The DHCP option 82 is working on the DHCP snooping or/and DHCP relay.

The switch will monitor the DHCP packets and append some information as below to the DHCPDISCOVER and DHCPREQUEST packets. The switch will remove the DHCP Option 82 from the DHCP OFFER and DHCPACK packets. The DHCP server will assign IP domain to the client dependent on these information.

The maximum length of the information is 32 characters.

In residential, metropolitan Ethernet-access environments, DHCP can centrally manage the IP address assignments for a large number of subscribers. When the DHCP option-82 feature is enabled on the switch, a subscriber device is identified by the switch port through which it connects to the network (in addition to its MAC address). Multiple hosts on the subscriber LAN can be connected to the same port on the access switch and are uniquely identified.

When you enable the DHCP snooping information option 82 on the switch, this sequence of events occurs:

- The host (DHCP client) generates a DHCP request and broadcasts it on the network.
- When the switch receives the DHCP request, it adds the option-82 information in the packet. The option-82 information contains the switch MAC address (the remote-ID sub-option) and the port identifier, vlan-mod-port, from which the packet is received (the circuit-ID sub-option).
- If the IP address of the relay agent is configured, the switch adds the IP address in the DHCP packet.
- The switch forwards the DHCP request that includes the option-82 field to the DHCP server.
- The DHCP server receives the packet. If the server is option-82 capable, it can use the remote ID, the circuit ID, or both to assign IP addresses and implement policies, such as restricting the number of IP addresses that can be assigned to a single remote ID or circuit ID. Then the DHCP server **echoes** the option-82 field in the DHCP reply.
- The DHCP server unicast's the reply to the switch if the request was relayed to the server by the switch. When the client and server are on the same subnet, the server broadcasts the reply. The switch verifies that it originally inserted the option-82 data by inspecting the remote ID and possibly the circuit ID fields. The switch **removes** the option-82 field and forwards the packet to the switch port that connects to the DHCP client that sent the

DHCP request.

Option Frame Format:

Code	Len	Agent Information Field					
82	N	i1	i2	i3	i4	...	iN

The Agent Information field consists of a sequence of Sub-Opt/Length value for each sub-option, encoded in the following manner:

Sub-Option	Len	Sub-Option Value					
1	N	s1	s2	s3	s4	...	sN

DHCP Agent Sub-option Code	Sub-Option Description
----- 1	----- Agent Circuit ID Sub-option
2	Agent Remote ID Sub-option

Circuit ID Sub-option Format:

Sub-option Type	Length	Information
0x01		Circuit Form

Remote ID Sub-option Frame Format:

Sub-option Type	Length	Type	Length	MAC Address
0x02	8	0	6	6

Circuit Form:

The circuit form is a flexible architecture. It allows user to combine any information or the system configurations into the circuit sub-option.

The Circuit Form is a string format. And its maximum length is 100 characters.

The keyword, %SPACE, will be replaced with a space character.

The other keywords get system configurations from the system and then replace the keyword and its leading code in the Circuit form. Eventually, the content of the circuit form is part of the payload on the DHCP option 82 packet.

Rules:

- The keyword must have a leading code '%'. For example: %*HOSTNAME*.
- If there are any characters following the keywords, you must add '+' between the keyword and character. For example: %*HOSTNAME*+/.
- If there are any characters before the keyword, you must add '+' between the character and the keyword. For example: *Test*+%*HOSTNAME*.

Keyword:

HOSTNAME - Add the system name into the Circuit sub-option..

SPACE - Add a space character.

- SVLAN - Add the service provider VLAN ID into the Circuit sub-option.
If the service provider VLAN is not defined, the system will return PVLAN.
- CVLAN - Add the customer VLAN ID into the Circuit sub-option.
If the CVLAN is not defined, the system returns 0.
- PORT - Add the transmit port ID into the Circuit sub-option.
- FRAME - Add the frame ID into the Circuit sub-option.
The frame ID is configured with the CLI command, “dhcp-options option82 circuit_frame VALUE”. Or GUI Circuit Frame.
- SHELF - Add the shelf ID into the Circuit sub-option.
The shelf ID is configured with the CLI command, “dhcp-options option82 circuit_shelf VALUE”. Or GUI Circuit Shelf.
- SLOT - Add the slot ID into the Circuit sub-option.
The slot ID is configured with the CLI command, “dhcp-options option82 circuit_slot VALUE”. Or GUI Circuit Slot.

For Example:

HOSTNAME=L2SWITCH.
SVLAN=44.
CVLAN=32.

Circuit Form=RD+%SPACE+Department+%SPACE+%HOSTNAME+%SPACE+%PORT+_%SVLAN+.%CVLAN
The circuit sub-option result is: RD Department L2SWITCH 1_44.32

6.7.2.1 CLI Configuration

Node	Command	Description
enable	show dhcp-options	This command displays the DHCP options configurations.
enable	configure terminal	This command changes the node to configure node.
configure	dhcp-options option82 (disable enable)	This command disables / enables the DHCP option 82 on the Switch.
configure	dhcp-options option82 circuit_id STRING	This command configures the information of the circuit ID sub-option.
configure	no dhcp-options option82 circuit_id	This command removes the information of the circuit ID sub-option.
configure	dhcp-options option82 remote_id STRING	This command configures the information of the remote ID sub-option.
configure	no dhcp-options option82 remote_id	This command removes the information of the remote ID sub-option.
configure	dhcp-options option82 circuit_frame VALUE	This command configures the frame ID for the circuit sub-option.
configure	dhcp-options option82 circuit_shelf VALUE	This command configures the shelf ID for the circuit sub-option.
configure	dhcp-options option82 circuit_slot VALUE	This command configures the slot ID for the circuit sub-option.

6.7.2.2 Web Configuration

DHCP Options

Option 66 & 67
Option 82

Option 82 Settings

State: ▾

Circuit Frame:

Circuit Shelf:

Circuit Slot:

Circuit-ID String:

Remote-ID String:

Option 82 Port Command Settings

Port: ▾

State: ▾

Circuit-ID String:

Remote-ID String:

Option 82 Port Command Status

Port 1	
State	Disabled
Circuit-ID String	
Remote-ID String	
Port 2	
State	Disabled
Circuit-ID String	
Remote-ID String	

Parameter	Description
Option 82 Settings	
State	Select this option to enable / disable the DHCP option 82 on the Switch.
Circuit Frame	The frame ID for the circuit sub-option.
Circuit Shelf	The shelf ID for the circuit sub-option.
Circuit Slot	The slot ID for the circuit sub-option.
Circuit-ID String	The String of the circuit ID sub-option information.

Remote-ID String	The String of the remote ID sub-option information.
Apply	Click Apply to take effect the settings.
Refresh	Click Refresh to begin configuring this screen afresh.
Option 82 Port Settings	
Port	The port ID.
Circuit-ID String	The String of the circuit ID sub-option information for the specific port.
Remote-ID String	The String of the remote ID sub-option information for the specific port.

6.8 DHCP Relay

Because the *DHCPDISCOVER* message is a broadcast message, and broadcasts only cross other segments when they are explicitly routed, you might have to configure a DHCP Relay Agent on the router interface so that all DHCPDISCOVER messages can be forwarded to your DHCP server. Alternatively, you can configure the router to forward DHCP messages and BOOTP message. *In a routed network, you would need DHCP Relay Agents if you plan to implement only one DHCP server.*

The DHCP Relay that either a host or an IP router that listens for DHCP client messages being broadcast on a subnet and then forwards those DHCP messages directly to a configured DHCP server. The DHCP server sends DHCP response messages directly back to the DHCP relay agent, which then forwards them to the DHCP client. The DHCP administrator uses DHCP relay agents to centralize DHCP servers, avoiding the need for a DHCP server on each subnet.

Most of the time in small networks DHCP uses broadcasts however there are some circumstances where unicast addresses will be used. A router for such a subnet receives the DHCP broadcasts, converts them to unicast (with a destination MAC/IP address of the configured DHCP server, source MAC/IP of the router itself). The field identified as the GIADDR in the main DHCP page is populated with the IP address of the interface on the router it received the DHCP request on. The DHCP server uses the **GIADDR** field to identify the subnet the device and select an IP address from the correct pool. The DHCP server then sends the DHCP OFFER back to the router via unicast which then converts it back to a broadcast and out to the correct subnet containing the device requesting an address.

Configurations:

Users can enable/disable the DHCP Relay on the Switch. Users also can enable/disable the DHCP Relay on a specific VLAN. If the DHCP Relay on the Switch is disabled, the DHCP Relay is disabled on all VLANs even some of the VLAN DHCP Relay are enabled.

Applications

- Application-1 (Over a Router)
The DHCP client-1 and DHCP client-2 are located in different IP segments. But they allocate IP address from the same DHCP server.

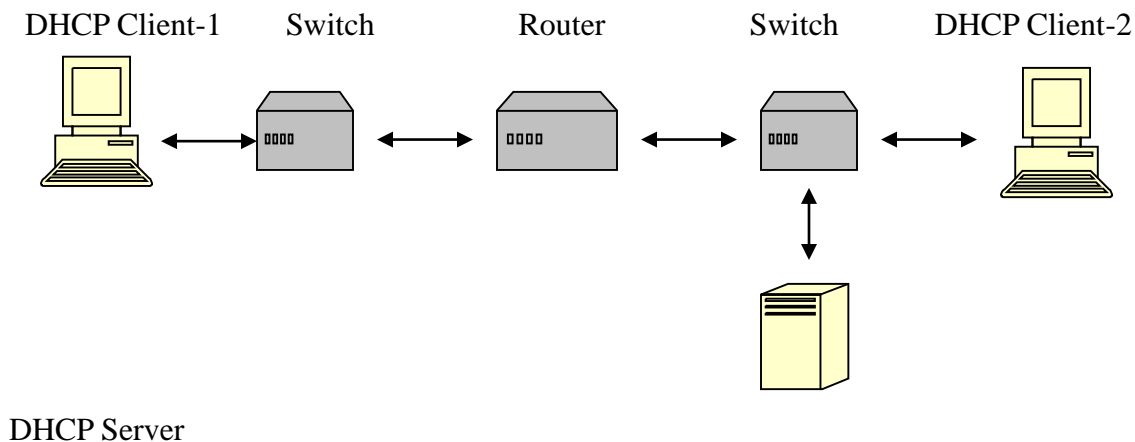

- Application-2 (Local in different VLANs)
The DHCP client-1 and DHCP client-2 are located in different VLAN. But they allocate IP address from the same DHCP server.

Switch DHCP Relay agent

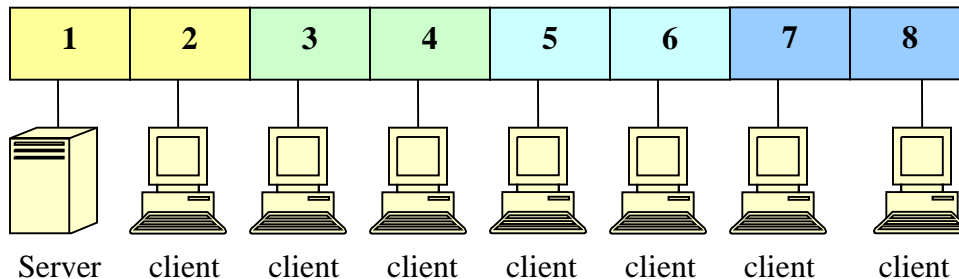

VLAN 1: port 1,2 (Management VLAN)

VLAN 2: port 3, 4

VLAN 3: port 5, 6

VLAN 4: port 7, 8

DHCP Server → Port 1.

DHCP Client → Port 2, 3, 4, 5, 6, 7, 8.

Result: Hosts connected to port 2,3,4,5,6,7,8 can get IP from DHCP server.

Note: The DHCP Server must connect to the management VLAN member ports.

The DHCP Relay in management VLAN should be enabled.

Default Settings

The default global DHCP relay state is disabled.

The default VLAN DHCP relay state is disabled for all VLANs.

The default DHCP server is 0.0.0.0

6.8.1 CLI Configuration

Node	Command	Description
enable	show dhcp relay	This command displays the current configurations for the DHCP relay.
enable	configure terminal	This command changes the node to configure node.
configure	dhcp relay (disable enable)	This command disables/enables the DHCP relay on the switch.
configure	dhcp relay vlan VLAN_RANGE	This command enables the DHCP relay function on a VLAN or a range of VLANs.
configure	no dhcp relay vlan VLAN_RANGE	This command disables the DHCP relay function on a VLAN or a range of VLANs.
configure	dhcp helper-address IP_ADDRESS	This command configures the DHCP server's IP address.
configure	no dhcp helper-address	This command removes the DHCP server's IP address.

Example:

```
L2SWITCH#configure terminal
L2SWITCH(config)#interface eth0
L2SWITCH(config-if)#ip address 172.20.1.101/24
L2SWITCH(config-if)#ip address default-gateway 172.20.1.1
L2SWITCH(config)#dhcp relay enable
L2SWITCH(config)# dhcp relay vlan 1
L2SWITCH(config)# dhcp helper-address 172.20.1.1
```

6.8.2 Web Configuration

DHCP Relay

DHCP Relay Settings

State Disable ▾

VLAN State Add ▾

DHCP Server IP

DHCP Relay Status

DHCP Relay State	Disabled
Enabled on VLAN	None
DHCP Server IP	0.0.0.0

Parameter	Description
DHCP Relay Settings	
State	Enables/ disables the DHCP relay for the Switch.
VLAN State	Enables / disables the DHCP relay on the specific VLAN(s).
DHCP Server IP	Configures the DHCP server’s IP address.
Apply	Click Apply to take effect the settings.
Refresh	Click Refresh to begin configuring this screen afresh.

6.9 Dual Homing

Dual Homing is a network topology in which a device is connected to the network by way of two independent access points (points of attachment). One access point is the primary connection, and the other is a standby connection that is activated in the event of a failure of the primary connection.

How Dual-Homing Works?

Assume the primary connection and secondary connections are connected to Internet by different way. For example, primary connection is connected to a physical network but secondary connection is connected to a wireless network. When enable dual homing feature, device will default connect to Internet by primary connection and secondary connection will be shutdown. If the port or all ports of primary connection are link-down, the device will replace primary connection by secondary connection to connect to Internet. At this situation, if secondary connection is also link-down, device will do nothing. Secondary connection only works as primary connection disconnecting.

Notices

If the channel is a single port, then the port cannot add into any trunk group.

6.9.1 CLI Configuration

Node	Command	Description
enable	show dual-homing	This command displays the dual-homing information.
enable	configure terminal	This command changes the node to configure node.
configure	dual-homing (disable enable)	This command disables / enables the dual-homing function for the system.
configure	dual-homing primary-channel (port trunk) VALUE	This command sets the dual-homing primary channel for the system. The channel can be a single port or a trunk group.
configure	no dual-homing primary-channel	This command removes the dual-homing primary channel for the system.
configure	dual-homing secondary-channel (port trunk) VALUE	This command sets the dual-homing secondary channel for the system. The channel can be a single port or a trunk group.
configure	no dual-homing secondary-channel	This command removes the dual-homing secondary channel for the system.

Example:

```
L2SWITCH(config)#link-aggregation 1 ports 5-6
L2SWITCH(config)#link-aggregation 1 enable
L2SWITCH(config)#dual-homing primary-channel port 2
L2SWITCH(config)#dual-homing secondary -channel trunk 1
L2SWITCH(config)#dual-homing enable
```

6.9.2 Web Configuration

Dual Homing

Dual Homing Settings

State Disable ▾

Group ID 1 ▾

Group State Disable ▾

Primary Channel Add ▾ Port ▾ 0

Secondary Channel Add ▾ Port ▾ 0

Dual Homing Status

Group Id	1
Group State	Disabled
Primary Channel	None
Secondary Channel	None
Group Id	2
Group State	Disabled
Primary Channel	None
Secondary Channel	None
Group Id	3
Group State	Disabled
Primary Channel	None
Secondary Channel	None
Group Id	4
Group State	Disabled
Primary Channel	None
Secondary Channel	None

Parameter	Description
Dual Homing Settings	
State	Enables/ disables the Dual-Homing for the Switch.
Group ID	Selects a group which you want to configure.
Group State	Enables/ disables the Dual-Homing for a group.
Primary channel	Configures / Resets the primary channel for a group. The channel can be single port or a trunk group.

Secondary channel	Configures / Resets the secondary channel for a group. The channel can be single port or a trunk group.
Apply	Click Apply to take effect the settings.
Refresh	Click Refresh to begin configuring this screen afresh.

6.10 Energy Efficient Ethernet (EEE)

The Energy Efficient Ethernet (EEE) is an IEEE 802.3az standard that is designed to reduce power consumption in Ethernet networks during idle periods.

EEE can be enabled on devices that support low power idle (LPI) mode. Such devices can save power by entering LPI mode during periods of low utilization. In LPI mode, systems on both ends of the link can save power by shutting down certain services. EEE provides the protocol needed to transition into and out of LPI mode in a way that is transparent to upper layer protocols and applications.

Notice: This feature is for Ethernet copper ports only.

6.10.1 CLI Configurations

Node	Command	Description
enable	show interface IFNAME	This command displays the current port configurations.
enable	configure terminal	This command changes the node to configure node.
configure	interface IFNAME	This command enters the interface configure node.
interface	eee (disable enable)	This command enables / disables the EEE function on this port.

Example:

- L2SWITCH#configure terminal
- L2SWITCH(config)#interface gigabitethernet1/0/1
- L2SWITCH(config-if)#eee enable
Success!
- L2SWITCH(config-if)#eee disable
Success!

6.10.2 Web Configurations

Energy Efficient Ethernet

Energy Efficient Ethernet Settings

EEE Ports State:(The feature for copper ports only)

Select All Deselect All

2 4 6 8

1 3 5 7

Parameter	Description
Energy Efficient Ethernet Settings	
EEE Port State	Click a port to enable IEEE 802.3az Energy Efficient Ethernet on that port.
Select All	Click this to enable IEEE 802.3az Energy Efficient Ethernet across all ports.
Deselect All	Click this to disable IEEE 802.3az Energy Efficient Ethernet across all ports.
Apply	Click Apply to take effect the settings.
Refresh	Click Refresh to begin configuring this screen afresh.

6.11 ERPS

The ITU-T G.8032 **Ethernet Ring Protection Switching** feature implements protection switching mechanisms for Ethernet layer ring topologies. This feature uses the G.8032 **Ethernet Ring Protection (ERP)** protocol, defined in ITU-T G.8032, to provide protection for Ethernet traffic in a ring topology, while ensuring that no loops are within the ring at the Ethernet layer. The loops are prevented by blocking traffic on either a predetermined link or a failed link.

The Ethernet ring protection functionality includes the following:

- Loop avoidance
- The use of learning, forwarding, and Filtering Database (FDB) mechanisms

Loop avoidance in an Ethernet ring is achieved by guaranteeing that, at any time, traffic may flow on all but one of the ring links. This particular link is called the **ring protection link (RPL)** and under normal conditions this ring link is blocked, i.e., not used for service traffic. One designated Ethernet ring node, the **RPL owner** node, is responsible to block traffic at one end of the RPL. Under an Ethernet ring failure condition, the RPL owner node is responsible for unblocking its end of the RPL, unless the RPL has failed, allowing the RPL to be used for traffic. The other Ethernet ring node adjacent to the RPL, the **RPL neighbor** node, may also participate in blocking or unblocking its end of the RPL.

The Ethernet rings could support a multi-ring/ladder network that consists of conjoined Ethernet rings by one or more interconnection points. The protection switching mechanisms and protocol defined in this Recommendation shall be applicable for a multi-ring/ladder network, if the following principles are adhered to:

- R-APS channels are not shared across Ethernet ring interconnections;
- on each ring port, each traffic channel and each R-APS channel are controlled (e.g., for blocking or flushing) by the Ethernet ring protection control process (ERP control process) of only one Ethernet ring;
- Each major ring or sub-ring must have its own RPL.

In an Ethernet ring, without congestion, with all Ethernet ring nodes in the idle state (i.e., no detected failure, no active automatic or external command and receiving only "NR, RB" R-APS messages), with less than 1200 km of ring fiber circumference and fewer than 16 Ethernet ring nodes, the switch completion time (transfer time as defined in [ITU-T G.808.1]) for a failure on a ring link shall be less than **50ms**.

The ring protection architecture relies on the existence of an **APS protocol** to coordinate ring protection actions around an Ethernet ring.

The Switch supports up to **six** rings.

Guard timer -- All ERNs use a guard timer. The guard timer prevents the possibility of forming a closed loop and prevents ERNs from applying outdated R-APS messages. The guard timer activates when an ERN receives information about a local switching request, such as after a switch fail (SF), manual switch (MS), or forced switch (FS). When this timer expires, the

ERN begins to apply actions from the R-APS it receives. This timer cannot be manually stopped.

Wait to restore (WTR) timer -- The RPL owner uses the WTR timer. The WTR timer applies to the revertive mode to prevent frequent triggering of the protection switching due to port flapping or intermittent signal failure defects. When this timer expires, the RPL owner sends a R-APS (NR, RB) through the ring.

Wait to Block (WTB) timers -- This wait-to-block timer is activated on the RPL owner. The RPL owner uses WTB timers before initiating an RPL block and then reverting to the idle state after operator-initiated commands, such as for FS or MS conditions, are entered. Because multiple FS commands are allowed to co-exist in a ring, the WTB timer ensures that the clearing of a single FS command does not trigger the re-blocking of the RPL. The WTB timer is defined to be 5 seconds longer than the guard timer, which is enough time to allow a reporting ERN to transmit two R-APS messages and allow the ring to identify the latent condition. When clearing a MS command, the WTB timer prevents the formation of a closed loop due to the RPL owner node applying an outdated remote MS request during the recovery process.

Hold-off timer -- Each ERN uses a hold-off timer to delay reporting a port failure. When the timer expires, the ERN checks the port status. If the issue still exists, the failure is reported. If the issue does not exist, nothing is reported.

ERPS revertive and non-revertive switching

ERPS considers revertive and non-revertive operation. In revertive operation, after the condition (s) causing a switch has cleared, the traffic channel is restored to the working transport entity, i.e. blocked on the RPL. In the case of clearing of a defect, the traffic channel reverts after the expiry of a WTR timer, which is used to avoid toggling protection states in case of intermittent defects. In non-revertive operation, the traffic channel continues to use the RPL, if it is not failed, after a switch condition has cleared.

Control VLAN:

The pure ERPS control packets domain only, no other packets are transmitted in this vlan to guarantee no delay for the ERPS. So when you configure a Control VLAN for a ring, the vlan should be a new one. The ERPS will create this control vlan and its member ports automatically. The member port should have the Left and Right ports only.

In ERPS, the control packets and data packets are separated in different vlans. The control packets are transmitted in a vlan which is called the Control VLAN.

Notice:

Control VLAN and Instance:

In CLI or Web configurations, there are the Control VLAN and the Instance settings. If the Control VLAN is configured for a ring and you want to configure an instance for the ring. The control vlan of the instance must be same as the Control VLAN; otherwise, you will get an error. If you still want to use this instance, you can change the Control VLAN to same as the control vlan of the instance first. And then configures the instance.

Notices:

- The valid instance ID is from 1 to 30.
- The maximum active instance is 6.

6.11.1 Ring

6.11.1.1 CLI Configuration

Node	Command	Description
enable	show erps	This command displays the ERPS configurations.
enable	configure terminal	This command changes the node to configure node.
configure	erps enable	This command enables the global ERPS on the Switch.
configure	no erps enable	This command disables the global ERPS on the Switch.
configure	erps ring-id <1-255>	This command creates an ERPS ring and its ID and enter ERPS node.
configure	no erps ring-id <1-255>	This command creates an ERPS ring and enter ERPS node to configure detail ring configurations.
erps-ring	show	This command displays the configurations of the ring.
erps-ring	control-vlan <1-4094>	This command configures a control-vlan for the ERPS ring.
erps-ring	guard-timer <10-2000>	This command configures the Guard Timer for the ERPS ring. (default:500ms)
erps-ring	holdoff-timer <0-10000>	This command configures the Hold-off Timer for the ERPS ring. (default:0 ms)
erps-ring	left-port PORTID type [owner neighbor normal]	This command configures the left port and type for the ERPS ring.
erps-ring	mel <0-7>	This command configures a Control MEL for the ERPS ring.
erps-ring	name STRING	This command configures a name for the ERPS ring.
erps-ring	revertive	This command configures the revertive mode for the ERPS ring.
erps-ring	no revertive	This command configures then on-revertive mode for the ERPS ring.
erps-ring	right-port PORTID type [owner neighbor normal]	This command configures the right port and type for the ERPS ring.
erps-ring	ring enable	This command enables the ring.
erps-ring	no ring enable	This command disables the ring.
erps-ring	version (v1 v2)	This command configures a version for the ERPS ring.
erps-ring	wtr-timer <5-720>	This command configures the WTR Timer for the ERPS ring. (default: 5 minutes)

6.11.1.2 Web Configuration

ERPS

Ring
Instance

ERPS Global Settings

Global State Disable ▾

ERPS Ring Settings

Ring ID	<input type="text" value=""/>	<small>(1~255)</small>	State	Disable ▾
Ring Name	<input type="text" value=""/>		Revertive	Enable ▾
Instance	<input type="text" value="0"/>	<small>(0:Default, 0~30)</small>	Ring Type	Major-ring ▾
Control VLAN	<input type="text" value=""/>	<small>(1~4094)</small>	Version	v2 ▾
Holdoff Timer (ms)	<input type="text" value="0"/>	<small>(0~10000)</small>	WTR Timer (sec)	<input type="text" value="300"/> <small>(5~720)</small>
MEL	<input type="text" value="7"/>	<small>(0~7)</small>	Guard Timer (ms)	<input type="text" value="500"/> <small>(10~2000)</small>
Left Port	None ▾ Normal ▾		Right Port	None ▾ Normal ▾

Apply
Refresh

ERPS Ring Status

Parameter	Description
ERPS Ring Settings	
Global State	Enables / disables the global ERPS state.
Ring ID	Configures the ring ID. The Valid value is from 1 to 255.
State	Enables/ disables the ring state.
Ring Name	Configures the ring name.(Up to 32 characters)
Revertive	Enables / disables the revertive mode.
Instance	Configures the instance for the ring. The Valid value is from 0 to 30. 0-Disable means the ERPS is running in version 1. The control VLAN of the instance should be same as below Control VLAN.
Control VLAN	Configures the Control VLAN which is the ERPS control packets domain for the ring.
Version	Configures the version for the ring.
Hold-off Timer	Configures the Hold-off time for the ring. The Valid value is from 0 to

	10000 (ms).
WTR Timer	Configures the WTR time for the ring. The Valid value is from 5 to 12 (min).
MEL	Configures the Control MEL for the ring. The Valid value is from 0 to 7. The default is 7.
Guard Timer	Configures the Guard time for the ring. The Valid value is from 10 to 2000 (ms).
Left Port	Configures the left port and its type for the ring. The valid port type is one of Owner, Neighbor or Normal.
Right Port	Configures the right port and its type for the ring. The valid port type is one of Owner, Neighbor or Normal.
Apply	Click Apply to take effect the settings.
Refresh	Click Refresh to begin configuring this screen afresh.

6.11.2 Instance

For ERPS version 2, the instance is a profile specifies a control vlan and a data vlan or multiple data vlans for the ERPS. In ERPS, it can separate the control packets and data packets in different vlans. The control packets is in the Control VLAN and the data packets can be in one or multiple data vlan. And then user can assign an instance to an ERPS ring easily.

In ERPS version 1, if a port is blocked by ERPS, all packets are blocked.

In ERPS version 2, if a port is blocked by a ring of ERPS, only the packets belong to the vlans in the instance are blocked.

6.11.2.1 CLI Configuration

Node	Command	Description
enable	show erps instance	This command displays all of the ERPS instance configurations.
enable	show erps instance <1-30>	This command displays the specific ERPS instance configurations.
enable	configure terminal	This command changes the node to configure node.
configure	erps instance	This command enters the instance configure node.
config-erps -inst	instance <1-30> control-vlan <1-4094> data-vlan VLANLISTS	This command configures a new instance and specifies its control vlan and data vlan.
config-erps -inst	no instance <1-30>	This command removes an instance.
config-erps -inst	show	This command displays all of the instance configurations.

6.11.2.2 Web Configuration

ERPS

Ring
Instance

ERPS Instance Settings

Instance (1~30)

Control VLAN (1~4094) Data VLAN
(Multiple VLAN List, e.g. 1,2,5,10)

ERPS Instance Status

Parameter	Description
Instance Settings	
Instance	Configures the instance ID. The valid value is from 1 to 31.
Control VLAN	Configures the control vlan for the instance. The valid value is from 1 to 4094.
Data VLAN	Configures the data vlan for the instance. The valid value is from 1 to 4094. It can be one or multiple vlans.
Apply	Click Apply to take effect the settings.
Refresh	Click Refresh to begin configuring this screen afresh.

6.12 Link Aggregation

6.12.1 Static Trunk

Link Aggregation (Trunking) is the grouping of physical ports into one logical higher-capacity link. You may want to trunk ports if for example, it is cheaper to use multiple lower-speed links than to under-utilize a high-speed, but more costly, single-port link.

However, the more ports you aggregate then the fewer available ports you have. A trunk group is one logical link containing multiple ports. The Switch supports both static and dynamic link aggregation.

Note: In a properly planned network, it is recommended to implement static link aggregation only. This ensures increased network stability and control over the trunk groups on your Switch.

6.12.1.1 CLI Configuration

Node	Command	Description
enable	show link-aggregation	The command displays the current trunk configurations.
enable	configure terminal	This command changes the node to configure node.
configure	link-aggregation [GROUP_ID] (disable enable)	The command disables / enables the trunk on the specific trunk group.
configure	link-aggregation [GROUP_ID] load-balance (mac ip)	The command configures the load balance algorithm for the trunk group.
configure	link-aggregation [GROUP_ID] interface PORTLISTS	The command adds ports to a specific trunk group.
configure	no link-aggregation [GROUP_ID] interface PORTLISTS	The commands delete ports from a specific trunk group.

Example:

```
L2SWITCH#configure terminal
L2SWITCH(config)#link-aggregation 1 enable
L2SWITCH(config)#link-aggregation 1 ports 1-4
```

6.12.1.2 Web Configuration

Link Aggregation

Static Trunk
LACP
LACP Info.

Static Trunk Settings

Group State

Load Balance

Member Ports

Select All Deselect All

2 4 6 8 10 12

1 3 5 7 9 11

Trunk Group Status

Group ID	State	Load Balance	Member Ports
1	Disabled	MAC	
2	Disabled	MAC	
3	Disabled	MAC	
4	Disabled	MAC	
5	Disabled	MAC	
6	Disabled	MAC	

Member Ports: T is Trunk member port but no link, A is Trunk member and link up.

Parameter	Description
Static Trunk Settings	
Group State	Select the group ID to use for this trunk group, that is, one logical link containing multiple ports. Select Enable to use this static trunk group.
Load Balance	Configures the load balance algorithm (MAC/IP) for the specific trunk group.
Member Ports	Select the ports to be added to the static trunk group.
Apply	Click Apply to take effect the settings.
Refresh	Click Refresh to begin configuring this screen afresh.

6.12.2 LACP

The Switch adheres to the IEEE 802.3ad standard for static and dynamic (LACP) port trunking. The IEEE 802.3ad standard describes the Link Aggregation Control Protocol (LACP) for dynamically creating and managing trunk groups.

When you enable LACP link aggregation on a port, the port can automatically negotiate with the ports at the remote end of a link to establish trunk groups. LACP also allows port redundancy, that is, if an operational port fails, then one of the “standby” ports become operational without user intervention.

Please note that:

- You must connect all ports point-to-point to the same Ethernet switch and configure the ports for LACP trunking.
- LACP only works on full-duplex links.
- All ports in the same trunk group must have the same media type, speed, and duplex mode and flow control settings.
- Configure trunk groups or LACP before you connect the Ethernet switch to avoid causing network topology loops.

System Priority:

The switch with the lowest system priority (and lowest port number if system priority is the same) becomes the LACP “server”. The LACP “server” controls the operation of LACP setup. Enter a number to set the priority of an active port using Link Aggregation Control Protocol (LACP), the smaller the number, the higher the priority level.

System ID:

The LACP system ID is the combination of the LACP system priority value and the MAC address of the router.

Administrative Key:

The administrative key defines the ability of a port to aggregate with other ports. A port's ability to aggregate with other ports is determined by these factors:

- Port physical characteristics, such as data rate, duplex capability, and point-to-point or shared medium.
- Configuration restrictions that you establish.

Port Priority:

The port priority determines which ports should be put in standby mode when there is a hardware limitation that prevents all compatible ports from aggregating.

Default Settings

The default System Priority is 32768.

The default group LACP state is disabled for all groups.

6.12.2.1 CLI Configuration

Node	Command	Description
enable	show lacp counters [GROUP_ID]	This command displays the LACP counters for the specific group or all groups.
enable	show lacp port_priority	This command displays the port priority for the LACP.
enable	show lacp sys_id	This command displays the actor's and partner's system ID.
enable	configure terminal	This command changes the node to configure node.
configure	lacp (disable enable)	This command disables / enables the LACP on the switch.
configure	lacp GROUP_ID (disable enable)	This command disables / enables the LACP on the specific trunk group.
configure	clear lacp counters [PORT_ID]	This command clears the LACP statistics for the specific port or all ports.
configure	lacp system-priority <1-65535>	This command configures the system priority for the LACP. Note: The default value is 32768.
configure	no lacp system-priority	This command configures the default for the system priority for the LACP.
configure	interface IFNAME	This command enters the interface configure node.
interface	lacp port_priority <1-65535>	This command configures the priority for the specific port. Note: The default value is 32768.
interface	no lacp port_priority	This command configures the default for the priority for the specific port.
configure	interface range gigabitethernet1/0/POR TLISTS	This command enters the if-range configure node.
if-range	lacp port_priority <1-65535>	This command configures the priority for the specific ports. Note: The default value is 32768.
if-range	no lacp port_priority	This command configures the default for the priority for the specific ports.

6.12.2.2 Web Configuration

Link Aggregation

Static Trunk
LACP
LACP Info.

LACP Settings

State:

System Priority:

Group LACP:

Port Priority: From: To: :

LACP Group Status

Group ID	LACP State
1	Disabled
2	Disabled
3	Disabled
4	Disabled
5	Disabled
6	Disabled

LACP Port Priority Status

Port	Priority	Port	Priority
1	32768	2	32768
3	32768	4	32768
5	32768	6	32768
7	32768	8	32768
9	32768	10	32768
11	32768	12	32768

Parameter	Description
LACP Settings	
State	Select Enable from the drop down box to enable Link Aggregation Control Protocol (LACP). Select Disable to not use LACP.
System Priority	LACP system priority is a number between 1 and 65,535. The switch with the lowest system priority (and lowest port number if system priority is the same) becomes the LACP “server”. The LACP “server” controls the operation of LACP setup. Enter a number to set the priority of an active port using Link Aggregation Control Protocol (LACP). The smaller the number, the higher the priority level.
Group LACP	Select a trunk group ID and then select whether to Enable or Disable

	Group Link Aggregation Control Protocol for that trunk group.
Port Priority	Select a port or a range of ports to configure its (their) LACP priority.
Apply	Click Apply to take effect the settings.
Refresh	Click Refresh to begin configuring this screen afresh.

6.12.3 LACP Information

6.12.3.1 CLI Configurations

Node	Command	Description
enable	show lacp internal [GROUP_ID]	This command displays the LACP internal information for the specific group or all groups.
enable	show lacp neighbor [GROUP_ID]	This command displays the LACP neighbor's information for the specific group or all groups.

6.12.3.2 Web Configurations

Link Aggregation

Static Trunk
LACP
LACP Info.

LACP Information

Group ID

Neighbor Information: '-' means the port is link down.

Parameter	Description
LACP Information	
Group ID	Select a LACP group that you want to view.
Apply	Click Apply to take effect the settings.
Neighbors Information	
Port	The LACP member port ID.
System Priority	LACP system priority is used to determine link aggregation group (LAG) membership, and to identify this device to other switches during LAG negotiations. (Range: 0-65535; Default: 32768)
System ID	The neighbor Switch's system ID.
Port	The direct connected port Id of the neighbor Switch.

Age	The available time period of the neighbor Switch LACP information.
Port State	The direct connected port's state of the neighbor Switch.
Port Priority	The direct connected port's priority of the neighbor Switch.
Oper Key	The Oper key of the neighbor Switch.
Internal Information	
Port	The LACP member port ID.
Port Priority	The port priority of the LACP member port.
Admin Key	The Admin key of the LACP member port.
Oper Key	The Oper key of the LACP member port.
Port State	The port state of the LACP member port.

6.13 Loop Detection

Loop detection is designed to handle loop problems on the edge of your network. This can occur when a port is connected to a Switch that is in a loop state. Loop state occurs as a result of human error. It happens when two ports on a switch are connected with the same cable. When a switch in loop state sends out broadcast messages the messages loop back to the switch and are re-broadcast again and again causing a broadcast storm.

The difference between the Loop Detection and STP:

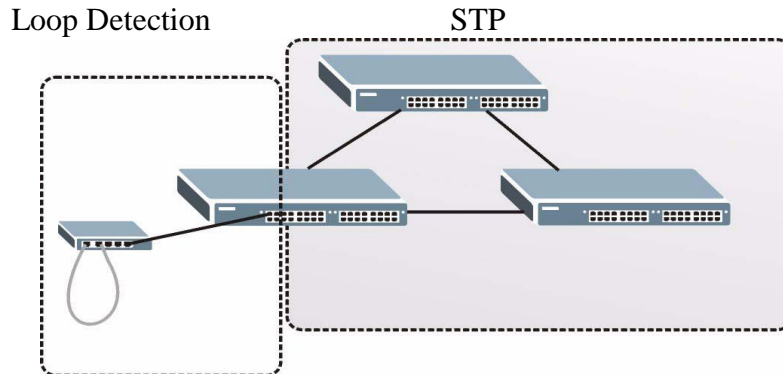

The loop detection function sends probe packets periodically to detect the loop in the network by checking the port loop state. The Switch shuts down that particular port if it detects the probe packets spiral back to the same port of Switch. Furthermore, the Switch generates Syslog, internal log messages, SNMP traps, and turns on the Alarm (ALM) LED when it shuts down the port via the loop detection feature.

Loop Recovery:

When the loop detection is enabled, the Switch will send one probe packet every two seconds periodically and listen to this packet. If it receives the same packet at the same port, the Switch will disable it. After a period (*recovery time*) the Switch will enable this port and continue to perform the loop detection again.

6.13.1 CLI Configuration

Node	Command	Description
enable	show loop-detection	This command displays the current loop detection configurations.
enable	configure terminal	This command changes the node to configure node.
configure	loop-detection (disable enable)	This command disables / enables the loop detection on the switch.
configure	loop-detection address MACADDR	This command configures the destination MAC for the loop detection special packets.
configure	no loop-detection address	This command configures the destination

		MAC to default (00:0b:04:AA:AA:AB).
configure	interface IFNAME	This command enters the interface configure node.
interface	loop-detection (disable enable)	This command disables / enables the loop detection on the port.
interface	no shutdown	This command enables the port. It can unblock port blocked by loop detection.
interface	loop-detection recovery (disable enable)	This command enables / disables the recovery function on the port.
interface	loop-detection recovery time <1-60>	This command configures the recovery period time.
configure	interface range gigabitethernet1/0/PORTLISTS	This command enters the if-range configure node.
if-range	loop-detection (disable enable)	This command disables / enables the loop detection on the ports.
if-range	loop-detection recovery (disable enable)	This command enables / disables the recovery function on the port.
if-range	loop-detection recovery time <1-60>	This command configures the recovery period time.

Example:

```
L2SWITCH(config)#loop-detection enable
L2SWITCH(config)#interface 1/0/1
L2SWITCH(config-if)#loop-detection enable
```

6.13.2 Web Configuration

Loop Detection

Loop Detection Settings

State: ▾

MAC Address:

Port	State	Recovery State	Recovery Time(min)
From: <input type="text" value="1"/> ▾ To: <input type="text" value="1"/> ▾	<input type="text" value="Disable"/> ▾	<input type="text" value="Enable"/> ▾	<input type="text" value="1"/> (Range: 1-60)

Loop Detection Status

Port	State	Status	Manual Recovery	Recovery State	Recovery Time(min)
1	Disabled	Normal	<input type="button" value="Unblock"/>	Enabled	1
2	Disabled	Normal	<input type="button" value="Unblock"/>	Enabled	1
3	Disabled	Normal	<input type="button" value="Unblock"/>	Enabled	1
4	Disabled	Normal	<input type="button" value="Unblock"/>	Enabled	1
5	Disabled	Normal	<input type="button" value="Unblock"/>	Enabled	1
6	Disabled	Normal	<input type="button" value="Unblock"/>	Enabled	1
7	Disabled	Normal	<input type="button" value="Unblock"/>	Enabled	1
8	Disabled	Normal	<input type="button" value="Unblock"/>	Enabled	1
9	Disabled	Normal	<input type="button" value="Unblock"/>	Enabled	1
10	Disabled	Normal	<input type="button" value="Unblock"/>	Enabled	1
11	Disabled	Normal	<input type="button" value="Unblock"/>	Enabled	1
12	Disabled	Normal	<input type="button" value="Unblock"/>	Enabled	1

Parameter	Description
Loop Detection Settings	
State	Select this option to enable loop guard on the Switch.
MAC Address	Enter the destination MAC address the probe packets will be sent to. If the port receives these same packets the port will be shut down.
Port	Select a port on which to configure loop guard protection.
State	Select Enable to use the loop guard feature on the Switch.
Recovery State	Select Enable to reactivate the port automatically after the designated recovery time has passed.
Recovery Time	Specify the recovery time in minutes that the Switch will wait before reactivating the port. This can be between 1 to 60 minutes.

Apply	Click Apply to take effect the settings.
Refresh	Click Refresh to begin configuring this screen afresh.
Loop Detection Status	
Port	This field displays a port number.
State	This field displays if the loop guard feature is enabled.
Status	This field displays if the port is blocked.
Manual Recovery	Clicks Unblock to reactivate the port manually.
Recovery State	This field displays if the loop recovery feature is enabled.
Recovery Time (min)	This field displays the recovery time for the loop recovery feature.

6.14 Modbus TCP

Modbus TCP supports different types of data format for reading. The primary four types of them are:

Data Access Type		Function Code	Function Name	Note
Bit access	Physical Discrete Inputs	2	Read Discrete Inputs	Not support now
	Internal Bits or Physical Coils	1	Read Coils	Not support now
Word access (16-bit access)	Physical Input Registers	4	Read Input Registers	
	Physical Output Registers	3	Read Holding Registers	Not support now

MODBUS Data Map and Information Interpretation of Volktek IE Switches

MODBUS base address of Volktek switches is 1001(decimal) for Function Code 4.

Address Offset	Data Type	Interpretation	Description
System Information			
0x0000	1 word	HEX	Vendor ID = 0x0b04
0x0001	16 words	ASCII	Vendor Name = "Volktek Corp." Word 0 Hi byte = 'V' Word 0 Lo byte = 'o' Word 1 Hi byte = 'I' Word 1 Lo byte = 'k' Word 2 Hi byte = 't' Word 2 Lo byte = 'e' Word 3 Hi byte = 'k' Word 3 Lo byte = '' Word 4 Hi byte = 'C' Word 4 Lo byte = 'o' Word 5 Hi byte = 'r' Word 5 Lo byte = 'p' Word 6 Hi byte = '.' Word 6 Lo byte = '\0'
0x0020	16 words	ASCII	Product Name = "IEN-8648A" Word 0 Hi byte = 'I' Word 0 Lo byte = 'E' Word 1 Hi byte = 'N' Word 1 Lo byte = '-' Word 2 Hi byte = '8' Word 2 Lo byte = '6' Word 3 Hi byte = '4' Word 3 Lo byte = '8' Word 4 Hi byte = 'A' Word 5 Lo byte = '\0'
0x0040	7 words		Product Serial Number Ex: Serial No=A00000000001

0x0050	12 words	ASCII	Firmware Version="8648-000-1.4.1.S0" Word 0 Hi byte = '8' Word 0 Lo byte = '6' Word 1 Hi byte = '4' Word 1 Lo byte = '8' Word 2 Hi byte = '-' Word 2 Lo byte = '0' Word 3 Hi byte = '0' Word 3 Lo byte = '0' Word 4 Hi byte = '-' Word 4 Lo byte = '1' Word 5 Hi byte = '.' Word 5 Lo byte = '4' Word 6 Hi byte = '.' Word 6 Lo byte = '1' Word 7 Hi byte = '.' Word 7 Lo byte = 'S' Word 8 Hi byte = '0' Word 8 Lo byte = '\0'
0x0060	16 words	ASCII	Firmware Release Date="Mon Sep 30 18:51:45 2013"
0x0070	3 words	HEX	Ethernet MAC Address Ex: MAC = 00-01-02-03-04-05 Word 0 Hi byte = 0 x 00 Word 0 Lo byte = 0 x 01 Word 1 Hi byte = 0 x 02 Word 1 Lo byte = 0 x 03 Word 2 Hi byte = 0 x 04 Word 2 Lo byte = 0 x 05
0x0080	1 word	HEX	Power 1(PWR) Alarm, DIP switch 1 need ON 0x0000: no alarm 0x0001: input voltage <44V 0x0002: input voltage > 57V 0x0003: No PWR input
0x0081	1 word	HEX	Power 2(RPS) Alarm, DIP switch 1 need ON 0x0000: no alarm 0x0001: input voltage <44V 0x0002: input voltage > 57V 0x0003: No RPS input
0x0090	1 word	HEX	Fault LED Status 0x0000: No 0x0001: Yes
Port Information			
0x0100 to 0x0109	1 word	HEX	Port 1 to 10Link Status 0x0000: Link down 0x0001: 10M-Full-FC_ON (FC: Flow Control) 0x0002: 10M-Full-FC_OFF 0x0003: 10M-Half-FC_ON 0x0004: 10M-Half-FC_OFF 0x0005: 100M-Full-FC_ON 0x0006: 100M-Full-FC_OFF 0x0007: 100M-Half-FC_ON 0x0008: 100M-Half-FC_OFF 0x0009: 1000M-Full-FC_ON 0x000A: 1000M-Full-FC_OFF 0x000B: 1000M-Half-FC_ON 0x000C: 1000M-Half-FC_OFF

			0xFFFF: No port
0x0200 to 0x0213 (port 1) 0x0220 to 0x0233 (port 2) ... 0x0320 to 0x0333 (port 6)	20 words	ASCII	Port 1 to 6 Description Port Description = "100TX,RJ45." Or "1000TX,SFP." Word 0 Hi byte = '1' Word 0 Lo byte = '0' Word 1 Hi byte = '0' Word 1 Lo byte = 'T' ... Word 4 Hi byte = '4' Word 4 Lo byte = '5' Word 5 Hi byte = '.' Word 5 Lo byte = '\0'
0x0400 to 0x0413 (port 1 to 6)	2 words	HEX	Port 1 to 6 Tx Packets Ex: port 1 Tx Packet Amount = 0x87654321 Word 0 =8765 Word 1 = 4321
0x0440 to 0x0453 (port 1 to 6)	2 words	HEX	Port 1 to 6 Rx Packets Ex: port 1 Rx Packet Amount = 0x123456 Word 0 = 0012 Word 1 = 3456
0x0480 to 0x0493 (port 1 to 6)	2 words	HEX	Port 1 to 6 Tx Error Packets Ex: port 1 Tx Error Packet Amount = 0x87654321 Word 0 =8765 Word 1 = 4321
0x04C0 to 0x04D3 (port 1 to 6)	2 words	HEX	Port 1 to 6 Rx Error Packets Ex: port 1 Rx Error Packet Amount = 0x123456 Word 0 = 0012 Word 1 = 3456
STP Information			
0x0500	1 word	HEX	STP Status: 0x0000 : STP is disabled. 0x0001 : STP 0x0002 : RSTP 0x0003 : MSTP
Xpress Ring Information			
0x0501	1 word	HEX	Xpress Ring Status on the Switch: 0x0000 : Disabled. 0x0001 : Enabled
0x0510	1 word	HEX	Status of Xpress-ring1 of the Switch 0x0000 : Disabled 0x0001 : Enabled
0x0511	1 word	HEX	Status of Xpress-ring2 of the Switch 0x0000 : Disabled 0x0001 : Enabled
0x0512	3 word	HEX	Destination MAC of the Xpress-ring1 Word 0 Lo byte = MAC0 Word 0 Hi byte = MAC1 Word 1Lo byte = MAC2 Word 1 Hi byte = MAC3 Word 2Lo byte = MAC4 Word 2 Hi byte = MAC5
0x0515	3 word	HEX	Destination MAC of the Xpress-ring2 Word 0 Lo byte = MAC0 Word 0 Hi byte = MAC1 Word 1Lo byte = MAC2 Word 1 Hi byte = MAC3

			Word 2Lo byte = MAC4 Word 2 Hi byte = MAC5
0x0518	1 word	HEX	Primary Port of the Xpress-ring1 Word 0 Hi byte = Port ID.
0x0519	1 word	HEX	Secondary Port of the Xpress-ring1 Word 0 Hi byte = Port ID.
0x051a	1 word	HEX	Primary Port of the Xpress-ring2 Word 0 Hi byte = Port ID.
0x051b	1 word	HEX	Secondary Port of the Xpress-ring2 Word 0 Hi byte = Port ID.
0x051c	1 word	HEX	Role of Xpress-ring1 0x0000 : Forwarder 0x0001 : Arbiter
0x051d	1 word	HEX	Role of Xpress-ring2 0x0000 : Forwarder 0x0001 : Arbiter
0x051e	1 word	HEX	Primary Port Status of Xpress-ring1 0x0000 : link down 0x0001 : forwarding 0x0002 : blocking
0x051f	1 word	HEX	Secondary Port Status of Xpress-ring1 0x0000 : link down 0x0001 : forwarding 0x0002 : blocking
0x0520	1 word	HEX	Primary Port Status of Xpress-ring2 0x0000 : link down 0x0001 : forwarding 0x0002 : blocking
0x0521	1 word	HEX	Secondary Port Status of Xpress-ring2 0x0000 : link down 0x0001 : forwarding 0x0002 : blocking

6.14.1 CLI Configuration

Node	Command	Description
enable	show modbus-tcp state	This command displays the current Modbus TCP configurations.
enable	show modbus-tcp register-addr range NUMRANGE	This command displays the range of the Modbus TCP registrations.
enable	configure terminal	This command changes the node to configure node.
configure	modbus-tcp (disable enable)	This command disables / enables the Modbus TCP on the switch.

6.14.2 Web Configuration

Modbus TCP

Modbus TCP Setting

State: ▾
 Connection: 0

Modbus TCP Information

Read Input Registers (Function Code 04)				
Modbus Address		Length	Interpretation	Description
Dec	Hex	Word		
System Information				
1001	3e9	1	HEX	Vendor ID
1002	3ea	16	ASCII	Vendor Name
1033	409	16	ASCII	Product Name
1065	429	7	ASCII	Product Serial Number
1081	439	12	ASCII	Firmware Version
1097	449	16	ASCII	Firmware Release Date
1113	459	3	HEX	Ethernet MAC Address
1129	469	1	HEX	Power 1(PWR) Alarm, DIP switch 1 need ON
1130	46a	1	HEX	Power 2(RPS) Alarm, DIP switch 1 need ON
1145	479	1	HEX	Fault LED Status
Port Information				
1257	4e9	1	HEX	Link Status of Port 1

Parameter	Description
Modbus TCP Settings	
State	Select this option to enable / disable the Modbus on the Switch.
Apply	Click Apply to take effect the settings.
Refresh	Click Refresh to begin configuring this screen afresh.
Modbus TCP Information	
Download	Clicks the Download button to download all of the registers information to load host.

6.15 PoE (Power over Ethernet)

6.15.1 PoE

Power over Ethernet or **PoE** technology describes a system to pass electrical power safely, along with data, on Ethernet cabling. PoE requires category 5 cable or higher for high power levels, but can operate with category 3 cable for low power levels. Power can come from a power supply within a PoE-enabled networking device such as an Ethernet switch or can be injected into a cable run with a mid-span power supply.

The original **IEEE 802.3af-2003** PoE standard provides up to 15.4 W of DC power (minimum 44 V DC and 350mA) to each device. Only 12.95 W is assured to be available at the powered device as some power is dissipated in the cable.

The updated **IEEE 802.3at-2009** PoE standard also known as **PoE++** or **PoE plus**, provides up to 25.5 W of power. Some vendors have announced products that claim to comply with the 802.3at standard and offer up to 51 W of power over a single cable by utilizing all four pairs in the Cat.5 cable. Numerous non-standard schemes had been used prior to PoE standardization to provide power over Ethernet cabling. Some are still in active use.

The new **IEEE 802.3bt-2013** standard enables delivery of 90W over four pairs of Cat5e cables and above. Such PoE level is expected to be the maximum level defined, as higher levels may not be safe for the existing cabling and connectors deployed in today's infrastructures. The standard will replace all existing pre-standard solutions that deliver 60W/75W/95W today, such as U PoE or 4PPoE.

PSE: Power sourcing equipment (PSE) is a device such as a switch that provides ("sources") power on the Ethernet cable.

PD: A powered device (PD) is a device such as an access point or a switch, that supports PoE(Power over Ethernet) so that it can receive power from another device through a 10/100 Mbps Ethernet port.

Standard PoE parameters and comparison

Property	802.3af (802.3at Type 1) "PoE"	802.3at Type 2 "PoE+"	802.3bt Type 3 "4PPoE"	802.3bt Type 4
Power available at PD	12.95 W	25.50 W	51 W	71 W
Maximum power delivered by PSE	15.40 W	30.0 W	60 W	100 W
Voltage range (at PSE)	44.0–57.0 V	50.0–57.0 V	50.0–57.0 V	52.0–57.0 V
Voltage range (at PD)	37.0–57.0 V	42.5–57.0 V	42.5–57.0 V	41.1–57.0 V
Maximum current I _{max}	350 mA	600 mA	600 mA per pair	960 mA per pair

Maximum cable resistance per pairset	20 Ω (Category 3)	12.5 Ω (Category 5)	12.5 Ω	12.5 Ω
Power management	Three power class levels (1-3) negotiated by signature	Four power class levels (1-4) negotiated by signature or 0.1 W steps negotiated by LLDP	Six power class levels (1-6) negotiated by signature or 0.1 W steps negotiated by LLDP	Eight power class levels (1-8) negotiated by signature or 0.1 W steps negotiated by LLDP
Derating of maximum cable ambient operating temperature	None	5 °C (9 °F) with one mode (two pairs) active	10 °C (20 °F) with more than half of bundled cables pairs at I _{max}	10 °C (20 °F) with temperature planning required
Supported cabling	Category 3 and Category 5	Category 5	Category 5	Category 5
Supported modes	Mode A (endspan), Mode B (midspan)	Mode A, mode B	Mode A, mode B, 4-pair mode	4-pair mode

Power Devices

Power levels available

Class	Usage	Classification [mA]	Power range [Watt]	Class description
0	Default	0 - 4	0.44 - 12.94	Classification unimplemented
1	Optional	9 - 12	0.44 - 3.84	Very Low power
2	Optional	17 - 20	3.84 - 6.49	Low power
3	Optional	26 - 30	6.49 - 12.95	Mid power
4	Reserved	36 - 44	12.95 - 25.50	High power

For IEEE 802.3at (type 2) devices class 4 instead of Reserved has a power range of 12.95 - 25.5 W.

PoE Specification

1. The port 1 ~ 4 supports the PoE function.
2. Total-power: The maximum power which the switch can support to the PDs.
Notice: You must reserve about 20 W for the system. That is, if you connect an external power supported 240W. The total power should be 220W only.
3. Schedule: The Switch allows user to arrange a week schedule to enable or disable the PoE for the specific ports.

Perpetual POE

The Perpetual POE provides uninterrupted power to connected powered device (PD) even when the power sourcing equipment (PSE) switch is booting.

Fast POE

This feature switches on power without waiting for IOS to boot up. When poe-ha is enabled on a particular port, the switch on a recovery after power failure, provides power to the connected endpoint devices within short duration before even the IOS forwarding starts up.

6.15.1.1 CLI Configuration

Node	Command	Description
enable	show poe	This command displays the PoE configurations and status.
enable	configure terminal	This command changes the node to configure node.
configure	poe (disable enable)	This command disables or enables the global PoE for the Switch.
configure	poe perpetual (enable disable)	This command disables or enables the PoE perpetual mode for the Switch.
configure	poe fast (enable disable)	This command disables or enables the fast PoE for the Switch.
configure	poe total-power	This command configures the total power which the Switch can support.
configure	interface IFNAME	This command enters the interface configure node.
interface	poe (disable enable)	This command enables or disables the PoE function on the specific port.
interface	poe priority(critical high low)	This command configures the priority of the PoE function for the specific port. <ul style="list-style-type: none"> ● critical : The highest priority. ● high : The middle priority. ● low : The lowest priority.

6.15.1.2 Web Configuration

PoE

Configuration
PD Alive Check
Power Delay
Schedule

PoE Settings

State Enable ▾

Total Power 260 (0~260)W

Total Power(P) = Current of adaptor(I) * Voltage of adaptor(V)

Port	State	LLDP Alloc	Priority	Max Power Limit
From: 1 ▾ To: 1 ▾	Enable ▾	Disable ▾	Low ▾	30 (0~30W)

Apply
Refresh

PoE Status

State	Enabled						
Total Power(W)	260						
Total Power Consumption(W)	0.0						
Port	State	LLDP Alloc	Status	Priority	Class	Max Power Limit(W)	Power Consumption(W)
1	Enabled	Disabled	Searching	Low	None	30	0.0
2	Enabled	Disabled	Searching	Low	None	30	0.0
3	Enabled	Disabled	Searching	Low	None	30	0.0
4	Enabled	Disabled	Searching	Low	None	30	0.0
5	Enabled	Disabled	Searching	Low	None	30	0.0
6	Enabled	Disabled	Searching	Low	None	30	0.0
7	Enabled	Disabled	Searching	Low	None	30	0.0
8	Enabled	Disabled	Searching	Low	None	30	0.0

Parameter	Description
PoE Settings	
State	Select this option to enable / disable the PoE on the Switch.
Fast PoE	Select this option to enable / disable the Fast PoE on the Switch.
Perpetual PoE	Select this option to enable / disable the Prepetual PoE on the Switch.
Total Power(W)	Configure the total power for the Switch.
Port	Selects a port or a range of ports that you want to configure the PoE function.
State	Select this option to enable / disable the PoE on the specific ports.
Priority	Selects Critical/ High / Low priority for the specific ports.

Maximum Power Limit	Configures maximum power limit for the specific ports.
Apply	Click Apply to take effect the settings.
Refresh	Click Refresh to begin configuring this screen afresh.
PoE Status	
State	Displays the PoE state for the Switch.
Fast PoE	Display the Fast PoE state for the Switch.
Perpetual PoE	Display the Perpetual PoE state for the Switch.
Total Power	Displays the total power that the Switch supports.
Total Consuming Power	Displays the total consuming power for all of the PDs.
External Power Module	Displays the status of the external power module.
Port	Display the Port No.
State	Displays the PoE state for the specific port.
PD Priority	Displays the PoE priority for the specific port.
Class	The field displays the class mode which the PSE negotiate with the PD on the specific port.
Consuming Power(mW)	Displays the consuming power for the specific port.
Power Allocated(mW)	Displays the power allocated for the specific port.
Current Status(mA)	Displays the current status for the specific port.

6.15.2 PD Alive Check

The function has a global *state* configuration. If the global state configuration is enabled. The Switch will check the configurations of every port.

If the port's *state* is enabled, the Switch will send keep-a-live probe packet every *interval* time. If the host cannot respond when the keep-a-live probe packet count is over the *retry times*, the Switch performs the *action*, *reboot/alarm/all* to the Power Device, depending on the port's configuration.

Power OFF Time (sec):

When PD has been rebooted, the PoE port restored power after the specified time.

Default:15, range: 3-120 sec.

Start up Time (sec):

When PD has been start up, the Switch will wait Start up time to do PoE Auto Checking.

Default: 60, range: 30-600 sec.

Interval Time (sec):

Device will send checking message to PD each interval time.

Default: 30, range: 10-120sec.

Action:

The action when the failure detection.

All: Send an alarm message to inform the administrator and then reboot the PD.

Alarm: Just send an alarm message to inform the administrator.

None: Keep Ping the remote PD but does nothing further.

Reboot: Cut off the power of the PoE port, make PD rebooted.

6.15.2.1 CLI Configuration

Node	Command	Description
enable	show pd-alive	This command displays the configuration of the PD Alive Check.
enable	configure terminal	This command changes the node to configure node.
configure	pd-alive (disable enable)	This command disables or enables the global PD Alive Check for the Switch.
configure	interface IFNAME	This command enters the interface configure node.
interface	pd-alive action (reboot alarm all none)	This command configures the action when the system detects that the host cannot respond the keep-a-live probe packet.
interface	pd-alive interval <10-120>	This command configures the interval to send the keep-a-live probe packets to check if the host is still alive for the specific port. Unit: second.
interface	pd-alive ip IP_ADDR	This command configures the Host IP address which connects to the specific port.
interface	pd-alive retry-time <1-5>	This command configures the retry times when no response from the host for the keep-a-live probe packet

		for the specific port.
interface	pd-alive power-off-time <3-120> startup-time <30-600>	This command configures the power-off time and startup time. Unit: second.

6.15.2.2 Web Configuration

PoE

Configuration
PD Alive Check
Power Delay
Schedule

PD Alive Check Settings

State Disable ▾

Port	State	IP Address	Interval (sec)	Retry Times	Action	Power Off Time(sec)	Start up Time(sec)
From: 1 ▾ To: 1 ▾	Disable ▾	<input style="width: 80px;" type="text" value="0.0.0.0"/>	<input style="width: 40px;" type="text" value="30"/>	<input style="width: 40px;" type="text" value="2"/>	All ▾	<input style="width: 40px;" type="text" value="15"/>	<input style="width: 40px;" type="text" value="60"/>

PD Alive Check Status

Port	State	IP Address	Interval (sec)	Retry Times	Action	Power Off Time(sec)	Start up Time(sec)
1	Disabled	0.0.0.0	30	2	All	15	60
2	Disabled	0.0.0.0	30	2	All	15	60
3	Disabled	0.0.0.0	30	2	All	15	60
4	Disabled	0.0.0.0	30	2	All	15	60
5	Disabled	0.0.0.0	30	2	All	15	60
6	Disabled	0.0.0.0	30	2	All	15	60
7	Disabled	0.0.0.0	30	2	All	15	60
8	Disabled	0.0.0.0	30	2	All	15	60

Parameter	Description
PD Alive Check Settings	
State	Enables/Disables the PD Alive Check.
Port	Selects a port or a range of ports which you want to configure.
State	Enables/Disables the PD Alive Check for the specific port(s).
IP Address	Specifies the Host IP address which connects to the port.
Interval	The interval to send the packet probes to check if the host is still alive.
Retry Time	The retry times when no response from the host for the keep-a-live probe packet.
Action	The action to the Power Device when the system detects that the Power Device cannot respond the keep-a-live probe packet. The

	options have Reboot / Alarm / All /None.
Power Off Time	When PD has been rebooted, the PoE port restored power after the Power Off Time.
Start Up Time	The Switch waits the Start Up Time to do PoE Auto Checking when the PD is rebooting.
Apply	Click Apply to take effect the settings.
Refresh	Click Refresh to begin configuring this screen afresh.

6.15.3 Power Delay

The Power Delay allows the user to setting the delay time of power providing after device rebooted.

6.15.3.1 CLI Configuration

Node	Command	Description
enable	show poe power-delay	This command displays the PoE power delay configurations.
enable	configure terminal	This command changes the node to configure node.
configure	interface IFNAME	This command enters the interface configure node.
interface	poe power-delay(enable disable)	This command enables / disables of the Power Delay function for the specific port.
interface	poe power-delay time <0-300>	This command configures the delay time of the Power Delay for the specific port.
configure	interface range gigabitethernet1/0/PORTLISTS	This command enters the if-range configure node.
if-range	poe power-delay(enable disable)	This command enables / disables of the Power Delay function for the range of ports.
if-range	poe power-delay time <0-300>	This command configures the delay time of the Power Delay for the range of ports.

6.15.3.2 Web Configuration

PoE

Configuration
PD Alive Check
Power Delay
Schedule

Power Delay Settings

Port	State	Time(sec)
From: <input type="text" value="1"/> To: <input type="text" value="1"/>	<input type="text" value="Disable"/>	<input type="text" value="0"/>
<input type="button" value="Apply"/> <input type="button" value="Refresh"/>		

Power Delay Status

Port	State	Time(sec)
1	Disabled	0
2	Disabled	0
3	Disabled	0
4	Disabled	0
5	Disabled	0
6	Disabled	0
7	Disabled	0
8	Disabled	0

Parameter	Description
Power Delay Settings	
Port	Selects a port or a range of ports which you want to configure.
State	Enables/Disables the PoE Power Delay for these specific ports.
Time	The delay time for the specific ports.
Apply	Click Apply to take effect the settings.
Refresh	Click Refresh to begin configuring this screen afresh.

6.15.4 PoE Schedule

The function has a global *state* configuration. If the global state configuration is disabled. The Switch will not perform the schedule function. If the global state is enabled, the Switch will check every port's configurations.

If the port's *check* configuration is NO for a specific day, the Switch will not perform action for the specific port. If the port's *check* configuration is YES for a specific day, the Switch will check the *Start time* and *End Time*. If the current time is in the interval between *Start time* and *End Time*, the Switch will perform the *action* configuration. If the *action* is ENABLE, the Switch will send power to the port. If the current time is not in the interval between *Start time* and *End Time*, the Switch will not send power to the port.

6.15.4.1 CLI Configuration

Node	Command	Description
enable	show poe schedule port PORT_ID	This command displays the PoE port schedule configurations.
enable	configure terminal	This command changes the node to configure node.
configure	interface IFNAME	This command enters the interface configure node.
interface	poe schedule (disable enable)	This command disables or enables the PoE schedule on the specific port.
interface	poe schedule week (Sun Mon Tue Wed Thu Fri Sat) check (yes no)	This command enables or disables the PoE schedule on the specific day.
interface	poe schedule week (Sun Mon Tue Wed Thu Fri Sat) start-time VALUE end-time VALUE action (enable disable)	This command configures the PoE schedule start-time and end-time on a specific day on the specific port. Users can enable or disable the PoE on the time period.

6.15.4.2 Web Configuration

PoE

Configuration
PD Alive Check
Power Delay
Schedule

Schedule Settings

Port 1 ▾
 State Disable ▾

Week	Check	Action	Time (hour)
Monday ▾	No ▾	Enable ▾	From: 0 ▾ To: 24 ▾

Apply
Refresh

Schedule Status

Port	1			
State	Disabled			
Current Time	Wednesday 0:5:11			
Week	Check	Action	Start Time (hour)	End Time (hour)
Monday	No	Enable	0	24
Tuesday	No	Enable	0	24
Wednesday	No	Enable	0	24
Thursday	No	Enable	0	24
Friday	No	Enable	0	24
Saturday	No	Enable	0	24
Sunday	No	Enable	0	24

Parameter	Description
Schedule Settings	
Port	Selects a port that you want to configure the PoE schedule function.
State	Enables/Disables the PoE schedule for the specific ports.
Week	Select a week day that you want to configure the schedule.
Check	Enables or Disables the PoE schedule on the specific port for a defined time period.
Action	Enables / Disables the PoE on the specific port for a defined time period.
Time (Hour)	Select the schedule time period.
Apply	Click Apply to take effect the settings.

6.16 PTP (IEEE-1588 V2)

PTP (Precision Time Protocol) is a distributed protocol to do time synchronization with each other systems in the network.

There are 4 different clocks in PTP:

1. **Ordinary Clock:** Switch communicates with the network by using specified single port. It will be same as grand master clock.
2. **Boundary Clock:** Switch can use multiple ports to communicate with network and each port behaves as ordinary clock. Port is selected as either master or member based on its local clock and data sets.
3. **Transparent Clock:** It forwards all received PTP messages and measures and accumulate delay timers in correction field.
4. **Forward Clock:** It forward all received PTP messages in domain ports.

PTP works in 2 phases:

1. **Establishing hierarchy:** Only ordinary or boundary clocks will have this phase.
 - a. Processes all received announce messages by using “Best Master Clock (BMC)” algorithm and identifies itself as either master or member.
2. **Clock Synchronization:**
 - a. Master sends “Sync” message to member
 - b. Member sends “DReq (Delay Request)” message to master
 - c. Master sends “Dresp (Delay Response)” message to member
 - d. Member will adjust its clock by using parameters in above messages.

6.16.1 General Settings

6.16.1.1 CLI Configuration

Node	Command	Description
Enable	show ptp information	This command displays PTP global configurations, PTP domain configurations and PTP port configurations.
enable	configure terminal	This command changes the node to configure node.
configure	ptp enable	This command enables PTP.
configure	no ptp enable	This command disables PTP.
configure	ptp primary-domain <0-127>	This command configures a specified Domain ID as the PTP’s primary domain.
configure	no ptp primary-domain	This command resets the primary domain ID default domain ID (0).

Example:

- Enabling PTP: This command is used to enable PTP; by default PTP is disabled
`L2SWITCH(config)#ptp enable`

- Disabling PTP: This command is used to disable PTP
L2SWITCH(config)#no ptp enable
- Adding Primary Domain: This command is used to add specified domain ID as primary domain in PTP; By default primary domain ID is 0.
L2SWITCH(config)#ptp primary-domain 1
- Deleting Primary Domain: This command is used to delete existing primary domain ID from PTP and adds default domain ID (0) as primary domain ID.
L2SWITCH(config)#no ptp primary-domain

6.16.1.2 Web Configuration

PTP

General Settings
Domain Settings
Port Settings

PTP Settings

PTP State

Domain ID (Range:0-127)

Primary Domain

PTP Status

PTP Status	Enabled	PTP Primary Domain	1
Domain ID	1	Domain Status	Disable
Slave	Disable	Path Trace	Disable
Clock	Forward(Default)	Two Step Clock	Disable
Clock Priority_1	128(default)	Clock Priority_2	128(default)
Acceptable Master Priority	128(Default)		

Parameter	Description
PTP Settings	
PTP State	Enables / Disables the global PTP state.
Domain ID	Creates / Removes a Domain.
Primary Domain	Configure the primary domain.
Apply	Click Apply to take effect the settings.

Refresh	Click Refresh to begin configuring this screen afresh.
PTP Status	
PTP Status	The current global PTP state.
PTP Primary Domain	Configure the primary domain.
Domain ID	Creates / Removes a Domain.
Domain Status	The current state of the domain.
Slave	The current slave mode of the domain.
Path Trace	The current path track mode of the domain.
Clock	The current clock mode of the domain.
Two Step Clock	The current Two Step clock mode of the domain.
Clock Priority_1	The priority of the clock 1 st priority of the domain.
Clock Priority_2	The priority of the clock priority2 of the domain.
Acceptable Master Priority	The priority of the acceptable master of the domain.

6.16.2 Domain Settings

6.16.2.1 CLI Configuration

Node	Command	Description
Enable	show ptp domain <Domain-ID>	This command displays specified PTP domain configurations.
enable	configure terminal	This command changes the node to configure node.
configure	ptp primary-domain <Domain-ID>	This command configures a specified Domain ID as the PTP's primary domain.
configure	no ptp primary-domain	This command resets the primary domain ID default domain ID (0).
configure	ptp domain <Domain-ID>	This command creates a specified domain in PTP.
configure	no ptp domain <Domain-ID>	This command deletes a specified domain ID from PTP.
ptp_config	domain enable	This command enables the PTP domain.
ptp_config	no domain enable	This command disables PTP domain.
ptp_config	clock-mode <ordinary boundary trans>	This command assigns specified clock mode in PTP domain.

	parent forward>	
ptp_config	no clock-mode	This command deletes existing clock mode of PTP domain and assigns default clock mode (Forward) in PTP domain.
ptp_config	clock-priority1 <Value>	This command assigns specified priority for PTP domain dataset's 1 st priority.
ptp_config	no clock-priority1	This command deletes existing 1 st priority from PTP domain clock and assigns default priority value (128).
ptp_config	clock-priority2 <Value>	This command assigns specified priority for PTP domain dataset's 2 nd priority.
ptp_config	no clock-priority2	This command deletes existing 2 nd priority from PTP domain clock and assigns default priority value (128).
ptp_config	path-trace	This command enables path trace TLV and adds TLV in list.
ptp_config	no path-trace	This command disables path trace TLV in domain and deletes it from list.
ptp_config	slave	This command enables PTP domain as slave. PTP domain will be act as member in PTP network.
ptp_config	no slave	This command disables PTP domain as slave only. Based on clock data sets it can be act as either slave or master.
ptp_config	two-step-clk	This command enables two step clock mode in PTP domain.
ptp_config	no two-step-clk	This command disables two step clock mode and acts as one step clock as default.
ptp_config	exit	This command provides command prompt one step as "config" node.
ptp_config	end	This command provides command prompt as "enable" node.

6.16.2.2 Web Configuration

PTP

Settings
Domain Settings
Port Settings

Domain Settings

Domain ID:

Domain: Path Trace:

Slave: Two Step Clock:

Clock Priority_1: (Range:0-255) Clock Priority_2: (Range:0-255)

Clock: Acceptable Master Priority: (Range:0-255)

Domain Status

Domain ID:

Domain ID	1	Domain Status	Enable
Slave	Disable	Path Trace	Disable
Clock	Forward(Default)	Two Step Clock	Disable
Clock Priority_1	128(default)	Clock Priority_2	128(default)
Acceptable Master Priority	0		

Parameter	Description
Domain Settings	
Domain ID	Selects a domain ID to configure.
Domain	Enables / Disables the domain.
Path Trace	Enable - enables path trace TLV and adds TLV in list. Disable - disables path trace TLV in domain and delete it from list.
Slave	Enable - enables PTP domain as slave. PTP domain will be act as member in PTP network. Disable - disables PTP domain as slave only. Based on clock data sets it can be act as either slave or master.
Two Step Clock	Enable –enables two step clock mode in PTP domain. Disable - disables two step clock mode and acts as one step clock as default.
Clock Priority_1	Configures a priority for PTP domain dataset's 1 st priority.

	The default priority value is 128.
Clock Priority_2	Configures a priority for PTP domain dataset's 2 nd priority. The default priority value is 128.
Clock	<p>Ordinary Clock - Switch communicates with the network by using specified single port. It will be same as grand master clock.</p> <p>Boundary Clock - Switch can use multiple ports to communicate with network and each port behaves as ordinary clock. Port is selected as either master or member based on its local clock and data sets.</p> <p>Transparent Clock - It forwards all received PTP messages and measures and accumulate delay timers in correction field.</p> <p>Forward Clock - It forward all received PTP messages in domain ports.</p>
Acceptable Master Priority	<p>Enable - enables PTP port in domain as acceptable master.</p> <p>Disable - deletes PTP port in domain from acceptable master list.</p>
Apply	Click Apply to take effect the settings.
Refresh	Click Refresh to begin configuring this screen afresh.
Domain Status	
Domain ID	The domain ID.
Domain Status	The current state of the domain.
Slave	The current slave mode of the domain.
Path Trace	The current path track mode of the domain.
Clock	The current clock mode of the domain.
Two Step Clock	The current Two Step clock mode of the domain.
Clock Priority_1	The priority of the clock 1 st priority of the domain.
Clock Priority_2	The priority of the clock priority2 of the domain.
Acceptable Master Priority	The priority of the acceptable master of the domain.

6.16.3 Port Settings

6.16.3.1 CLI Configuration

Node	Command	Description
Enable	show ptp port <Domain-ID> <Port-ID>	This command displays specified PTP domain and port configurations.
enable	configure terminal	This command changes the node to configure node.
configure	ptp primary-domain <Domain-ID>	This command configures a specified Domain ID as the PTP's primary domain.
configure	no ptp primary-domain	This command resets the primary domain ID default domain ID (0).
configure	ptp domain <Domain-ID>	This command creates a specified domain in PTP.
configure	no ptp domain <Domain-ID>	This command deletes a specified domain ID from PTP.
ptp_config	port <Port-ID>	This command creates port data sets in PTP domain.
ptp_config	no port <Port-ID>	This command deletes port data sets from PTP domain.
ptp_config_port	port enable	This command enables PTP port in domain.
ptp_config_port	no port enable	This command disables PTP port in domain.
ptp_config_port	acceptable-master enable	This command enables PTP port in domain as acceptable master.
ptp_config_port	no acceptable-master enable	This command deletes PTP port in domain from acceptable master list.
ptp_config_port	announce interval <0-4>	This command configures to send periodical announce messages in specified intervals in PTP port.
ptp_config_port	no announce interval	This command deletes existing announce interval from PTP port and adds default interval (1).
ptp_config_port	announce timeout <2-10>	This command configures specified value as announce time in PTP port.
ptp_config_port	no announce timeout	This command deletes existing announce timeout from PTP port and adds default timeout (3).
ptp_config_port	sync interval [-1, 1]	This command configures synchronization interval of PTP port as specified value.
ptp_config_port	no sync interval	This command deletes existing synchronization interval from PTP port and adds default value (0).
ptp_config_port	vlan <VLAN LIST>	This command configures specified VLAN list to PTP port.
ptp_config_port	no vlan <VLAN LIST>	This command deletes specified VLAN list from PTP port.

ptp_config_port	exit	This command provides command prompt one step as “ptp_config” node.
ptp_config_port	end	This command provides command prompt as “enable” node.

6.16.3.2 Web Configuration

PTP

General Settings
Domain Settings
Port Settings

Port Setting

Domain ID: ---

Port: Add --- Disable

Acceptable Master: Disable

Sync Interval: Add 0 (Range:-1-1)

Announce Interval: Add 1 (Range:0-4) Announce Timeout: Add 3 (Range:2-10)

Vlan ID: Add

Apply
Refresh

Port Status

Domain ID: 1 Port ID: 2 Show

Domain ID	1		
Port ID	2	Port Status	Enable
Announce Interval	1(Default)	Announce Timeout	3(Default)
Sync Interval	0(Default)		
Acceptable Master Status	Disable		
VLAN IDs	None		

Parameter	Description
Port Settings	
Domain ID	Selects a domain ID to configure.
Port	Selects a port to join the domain.
Acceptable Master	Enable - enables PTP port in domain as acceptable master. Disable - deletes PTP port in domain from acceptable master list.
Sync Interval	Add - configures synchronization interval of PTP port as specified value. Default - deletes existing synchronization interval from PTP port and adds default value (0).

Announce Interval	Add - configures to send periodical announce messages in specified intervals in PTP port. Default - deletes existing announce interval from PTP port and adds default interval (1).
Announce Timeout	Add - configures specified value as announce time in PTP port. Default - deletes existing announce timeout from PTP port and adds default timeout (3).
Vlan ID	Add - configures specified VLAN list to PTP port. Remove - deletes specified VLAN list from PTP port.
Apply	Click Apply to take effect the settings.
Refresh	Click Refresh to begin configuring this screen afresh.

6.17 PPPoE IA

PPPoE Intermediate Agent (PPPoE IA) is placed between a subscriber and BRAS to help the service provider BRAS distinguish between end hosts connected over Ethernet to an access switch. On the access switch, PPPoE IA enables Subscriber Line Identification by appropriately tagging Ethernet frames of different users (The tag contains specific information like which subscriber is connected to the switch and VLAN). PPPoE IA acts as mini security firewall between host and BRAS by intercepting all PPPoE Active Discovery (PAD) messages on a per-port per-vlan basis. It provides specific security feature such as verifying the intercepted PAD message from untrusted port, inserting and removing VSA Tags (vendor-specific tag) into and from PAD messages.

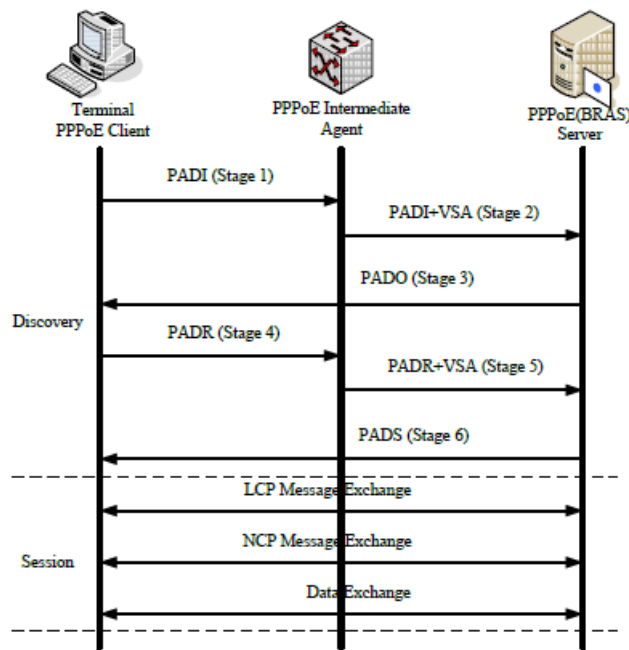

PPPoE Discovery Stage

1. The PPPoE client broadcasts a PADI packet that contains information about the service type it requests.
2. PPPoE IA intercepts PPPoE discovery frames from the client and inserts a unique line identifier (circuit-id/remote-id) using the PPPoE Vendor-Specific tag (0x0105) to PADI (PPPoE Active Discovery Initiation) packets. The PPPoE IA forwards these packets to the PPPoE server after the insertion.
3. After receiving a PADI packet that it can serve, a PPPoE server replies with a PADO packet. The destination address of the PADO packet is the unicast packet of the host that sent the PADI.
4. Depending on the network topology, since the PADI was broadcast, the PPPoE client may receive PADO packets sent by multiple PPPoE servers. Among these PPPoE servers, the PPPoE client selects the one whose PADO packet arrived the earliest and unicast's a PADR packet to the PPPoE server.
5. Depending on the network topology, since the PADI was broadcast, the PPPoE client may receive PADO packets sent by multiple PPPoE servers. Among these PPPoE servers, the

PPPoE client selects the one whose PADO packet arrived the earliest and unicasts a PADR packet to the PPPoE server.

6. PPPoEIA intercepts PPPoE discovery frames from the client and inserts a unique line identifier (circuit-id/remote-id) using the PPPoE Vendor-Specific tag (0x0105) to PADR (PPPoE Active Discovery Request) packets. The PPPoE IA forwards these packets to the PPPoE server after the insertion.
7. The PPPoE server generates a unique session ID for the session and sends the session ID to the PPPoE client through a PADS packet. If no error occurs, the session will thus be established and PPPoE moves on to the Session stage.

PPPoE Intermediate Agent Tag Format

If the PPPoE Intermediate Agent is enabled, the Switch adds a vendor-specific tag to PADI (PPPoE Active Discovery Initialization) and PADR (PPPoE Active Discovery Request) packets from PPPoE clients. This tag is defined in RFC 2516 and has the following format for this feature.

Table 1 PPPoE Intermediate Agent Vendor-specific Tag Format

Tag_Type (0x0105)	Tag_Len	Value	#1	#2
----------------------	---------	-------	----	----

The Tag_Type is 0x0105 for vendor-specific tags, as defined in RFC 2516. The Tag_Len indicates the length of Value, #1 and #2. The Value is the 32-bit number *0x00000DE9*, which stands for the “ADSL Forum” IANA entry. #1 and #2 are PPPoE intermediate agent sub-options, which contain additional information about the PPPoE client.

Sub-Option Format

There are two types of sub-option: “Agent Circuit ID Sub-option” and “Agent Remote ID Sub-option”. They have the following formats.

Table 2 PPPoE IA Circuit ID Sub-option Format: User-defined String

SubOpt	Length	Value
0x01 (1 byte)	N (1 byte)	String (64 bytes)

Table 3 PPPoE IA Remote ID Sub-option Format

SubOpt	Length	Value
0x02 (1 byte)	N (1 byte)	MAC Address or String (64 bytes)

The 0x01 in the first field identifies this as an Agent Circuit ID sub-option and 0x02 identifies this as an Agent Remote ID sub-option. The next field specifies the length of the field. The Switch takes the Circuit ID string you manually configure for a VLAN on a port as the highest priority and the Circuit ID string for a port as the second priority. In addition, the Switch puts the PPPoE client’s MAC address into the Agent Remote ID Sub-option if you do not specify any user-defined string.

Flexible Circuit ID Syntax with Identifier String and Variables

If you do not configure a Circuit ID string for a VLAN on a specific port or for a specific port, the Switch adds the user-defined identifier string and variables into the Agent Circuit ID

Sub-option. The system variables can be the host name of the access node (Switch), the port number of the PPPoE client and/or the VLAN ID on the PPPoE packet.

Table 4 PPPoE IA System Variable

SYSTEM VARIABLE	DESCRIPTION
%HOSTNAME	Host name of access node(Switch)
%SPACE	Space key(ASCII 0x20)
%PORT	Port number of the client
%SVLAN	Service provider VLAN ID
%CVLAN	Client VLAN ID

PS. %SVLAN equal to %CVLAN

Users can freely combined circuit ID, using the '+' symbol to links system variables and identifier strings, in order to meet specific requirements.

EX: CLI Command

```
pppoe intermediate-agent format-type user-defined
%HOSTNAME+%SPACE+atm+%SPACE+/0/0/+%PORT+:+%CVLAN
```

Table 5: PPPoE IA Circuit ID Sub-option Format: User-defined String and Variables

SubOpt	Length	Value								
0x01 (1 byte)	N (1 byte)	Host Name (x bytes)	Space (1 byte)	atm (3 bytes)	Space (1 byte)	/0/0/ (5 bytes)	Port ID (2 bytes)	:	(1 byte)	CVLAN ID (4 bytes)

WT-101 Default Circuit ID Syntax

If you do not configure a Circuit ID string for a specific VLAN on a port or for a specific port, and no set the flexible Circuit ID syntax in the Switch, the Switch automatically generates a Circuit ID string according to the default Circuit ID syntax which is defined in the DSL Forum Working Text (WT)-101. The default access node identifier is the hostname of the PPPoE intermediate agent and the eth indicates “Ethernet”, and the slot id is 0.

SubOpt	Length	Value										
0x01 (1 byte)	N (1 byte)	Access node identifier	Space (1 byte)	eth (3 bytes)	Space (1 byte)	Slot ID (1 byte)	/	(1 byte)	Port ID (2 bytes)	:	(1 byte)	CVLAN ID (4 bytes)

Port State

Every port is either a trusted port or an untrusted port for the PPPoE intermediate agent. This setting is independent of the trusted/untrusted setting for DHCP snooping. You can also specify the agent sub-options (circuit ID and remote ID) that the Switch adds to PADI and PADR packets from PPPoE clients.

Trusted ports are connected to PPPoE servers.

- If a PADO (PPPoE Active Discovery Offer), PADS (PPPoE Active Discovery Session-confirmation), or PADT (PPPoE Active Discovery Terminate) packet is sent from a PPPoE server and received on a trusted port, the Switch forwards it to all other ports.

- If a PADI or PADR packet is sent from a PPPoE client but received on a trusted port, the Switch forwards it to other trusted port(s).

Note: The Switch will drop all PPPoE discovery packets if you enable the PPPoE intermediate agent and there are no trusted ports.

- The trusted ports can keep/replace/strip vendor-tag of PADO and PADS packet.
 - ◆ Keep: means that the PPPoE agent will keep original vendor-tag in the PADO/PADS packet.
 - ◆ Replace: means that the PPPoE agent will replace the vendor-tag in the PADO/PADS packet with its own vendor-tag.
 - ◆ Strip: means that the PPPoE agent will strip the vendor-tag in the PADO/PADS packet (Default).

Untrusted ports are connected to subscribers.

- If a PADI, PADR, or PADT packet is sent from a PPPoE client and received on an untrusted port, the Switch adds a vendor-specific tag to the packet and then forwards it to the trusted port(s).
- The Switch discards PADO and PADS packets which are sent from a PPPoE server but received on an untrusted port.

6.17.1 Global Configuration

6.17.1.1 CLI Configuration

Node	Command	Description
enable	show pppoe intermediate-agent configuration	This command displays the current configurations for the PPPoE IA.
enable	configure terminal	This command changes the node to configure node.
configure	pppoe intermediate-agent <enable/disable>	This command disables / enables the PPPoE IA on the switch.
configure	pppoe intermediate-agent format-type user-defined <user-defined-string>	This command configures the user defined circuit ID string for the PPPoE IA.
configure	pppoe intermediate-agent vlan VLANLISTS	This command enablesthe PPPoE IAeither(a)aspecificVLAN,(b)acomma separatedlistlike"x,y,"or (c)arangelike "x-y".
configure	pppoe intermediate-agent circuit-id-vlan VLANLISTS	This command enablesthe PPPoE IAcircuit-idneither (a)aspecificVLAN, (b)a commaseparatedlist like"x,y,"or (c)arange like"x-y".
configure	pppoe intermediate-agent remote-id-vlan VLANLISTS	This command enables thePPPoE IAremote-idneither (a)aspecificVLAN, (b)a commaseparatedlist like"x,y,"or (c)arange like"x-y".

configure	no pppoe intermediate-agent format-type user-defined	This no command removes the user defined circuit ID for the PPPoE IA.
configure	no pppoe intermediate-agent vlan	This no command disable PPPoE IA on all VLANs.
configure	no pppoe intermediate-agent vlan VLANLISTS	This no command disables the PPPoE IA on specific VLANs.
configure	no pppoe intermediate-agent circuit-id-vlan	This no command disables the PPPoE IA circuit-id on all VLANs.
configure	no pppoe intermediate-agent circuit-id-vlan VLANLISTS	This no command disables the PPPoE IA circuit-id on specific VLANs.
configure	no pppoe intermediate-agent remote-id-vlan	This no command disables the PPPoE IA remote-id on all VLANs.
configure	no pppoe intermediate-agent remote-id-vlan VLANLISTS	This no command disables the PPPoE IA remote-id on specific VLANs.

Example:

```
L2SWITCH(config)#pppoe intermediate-agent enable
L2SWITCH(config)#pppoe intermediate-agent vlan 1-100,200,300
L2SWITCH(config)#pppoe intermediate-agent circuit-id-vlan 1-100,200,300
L2SWITCH(config)#pppoe intermediate-agent remote-id-vlan 1-100,200,300
L2SWITCH(config)#pppoe intermediate-agent format-type user-defined
%HOSTNAME+%SPACE+atm+%SPACE+/0/0/+%PORT+:+%CVLAN
```

6.17.1.2 Web Configuration

PPPoE IA Global Configuration

Global Configuration
Port Configuration
Statistics

PPPoE IA Global Configurations

PPPoE-IA: Disable ▼

User-Defined-String:
Ex: %HOSTNAME+%SPACE+atm+/1/0/+%PORT+.0200:%CVLAN

PPPoE IA VLAN Configurations

PPPoE IA: Add ▼ (1,2,10-20,....,4094)

Circuit-ID: Add ▼ (1,2,10-20,....,4094)

Remote-ID: Add ▼ (1,2,10-20,....,4094)

Apply
Refresh

Parameter	Description
PPPoE IA Global Configurations	

PPPoE-IA	Selects Enable to activate the PPPoE-IA or Disable to deactivate the PPPoE-IA.
User-Defined-String	User defined circuit ID string for the PPPoE IA.
PPPoE IA VLAN	Selects Add to increase the PPPoE-IA Vlan or Remove to delete the PPPoE-IA Vlan.
Circuit-ID VLAN	Selects Add to increase the Circuit-ID Vlan or Remove to delete the Circuit-ID Vlan.
Remote-ID VLAN	Selects Add to increase the Remote-ID Vlan or Remove to delete the Remote-ID Vlan.
Apply	Click Apply to take effect the settings.
Refresh	Click Refresh to begin configuring this screen afresh.

6.17.2 Port Configuration

6.17.2.1 CLI Configuration

Node	Command	Description
enable	show pppoe intermediate-agent configuration	This command displays the current configurations for the PPPoE IA.
enable	configure terminal	This command changes the node to configure node.
configure	interface IFNAME	This command enters the interface configure node.
interface	pppoe intermediate-agent <enable disable>	This command disables / enables the PPPoE IA on specific interface for the PPPoE IA.
interface	pppoe intermediate-agent trust	This command sets physical interface as trusted port.
interface	pppoe intermediate-agent format-type <circuit-id remote-id><id-string>	This command sets circuit ID or remote ID string on specific interface for the PPPoE IA.
interface	pppoe intermediate-agent vendor-tag <keep replace strip>	This command is used to set the retransmitting policy of the specific interface for the PADO/PADS packet. Default:Keep
interface	pppoe intermediate-agent vlan VLANLISTS	This command enables the PPPoE IA on specific VLANs of interface.
interface	no pppoe intermediate-agent trust	This command sets physical interface as untrusted port.
interface	no pppoe intermediate-agent format-type <circuit-id remote-id>	This command removes circuit ID or remote ID string on specific interface for the PPPoE IA
interface	no pppoe intermediate-agent vendor-tag	The command sets the retransmitting policy of the specific interface as “keep”.
interface	no pppoe intermediate-agent vlan	This command disables the PPPoE IA on all VLANs.
interface	no pppoe intermediate-agent vlan VLANLISTS	This command disables the PPPoE IA on specific VLANs of interface.
if-pppoe-vlan	pppoe intermediate-agent format-type <circuit-id remote-id><id-string>	This command sets circuit ID or remote ID string on specific VLANs of interface for the PPPoE IA.
if-pppoe-vlan	no pppoe intermediate-agent format-type <circuit-id remote-id>	This command removes circuit ID or remote ID string on specific VLANs of interface for the PPPoE IA.

Example:

```
L2SWITCH(config)#pppoe intermediate-agent enable
```

```
L2SWITCH(config)#pppoe intermediate-agent vlan 1-100,200,300
```

```
L2SWITCH(config)#pppoe intermediate-agent circuit-id-vlan 1-100,200,300
```

```
L2SWITCH(config)#pppoe intermediate-agent remote-id-vlan 1-100,200,300
L2SWITCH(config)#pppoe intermediate-agent format-type user-defined
    %HOSTNAME+%SPACE+atm+%SPACE+/0/0/+%PORT+:+%CVLAN
L2SWITCH(config)#interface 1/0/1
L2SWITCH(config-if)#pppoe intermediate-agent enable
L2SWITCH(config-if)#interface 1/0/8
L2SWITCH(config-if)#pppoe intermediate-agent enable
L2SWITCH(config-if)#pppoe intermediate-agent trust
L2SWITCH(config-if)#pppoe intermediate-agent vlan 1
L2SWITCH(if-pppoe-vlan)#
```

6.17.2.2 Web Configuration

PPPoE IA Port Configuration

Global Configuration
Port Configuration
Statistics

PPPoE IA Port Configurations

Port	1 ▾	
State	Disable ▾	
Trusted	No ▾	
Vendor-Tag	Strip ▾	
Circuit-ID String	<input style="width: 100%;" type="text"/>	
Remote-ID String	<input style="width: 100%;" type="text"/>	

PPPoE IA Interface Vlan Configurations

VLAN	Add ▾	<input style="width: 90%;" type="text"/> (1,2,10-20,....,4094)
Circuit-ID String	<input style="width: 100%;" type="text"/>	
Remote-ID String	<input style="width: 100%;" type="text"/>	

PPPoE IA Port Status

Port	1 ▾	<input type="button" value="Show"/>
------	-----	-------------------------------------

PPPoE IA	Disable
Trusted	No
Policy	Strip
Circuit-ID String	
Remote-ID String	
Interface VLAN	
Circuit-ID String	
Remote-ID String	

Parameter	Description
-----------	-------------

PPPoE IA Port Configurations	
Port Number	Selects a port number you want to configure on this screen
State	Selects Enable to activate the port or Disable to deactivate the port
Trusted	Selects yes to sets a physical interface as trusted port
Vendor-Tag	Set the retransmitting policy of the specific interface for the PADO/PADS packet<keep replace strip>.Default:Keep
Circuit-ID String	User defined circuit ID string on specific interface for the PPPoE IA
Remote ID String	User defined remote ID string on specific interface for the PPPoE IA
Interface VLAN	Selects Add to increase the interface Vlan or Remove to delete the interface Vlan
Circuit-ID String	User defined circuit ID string on specific interface vlan for the PPPoE IA
Remote-ID String	User defined remote ID string on specific interface vlan for the PPPoE IA
Apply	Click Apply to take effect the settings.
Refresh	Click Refresh to begin configuring this screen afresh.

6.17.3 Statistics

6.17.3.1 CLI Configuration

Node	Command	Description
enable	show pppoe intermediate-agent statistics	This command displays the current statistics for the PPPoE IA.
enable	show pppoe intermediate-agent statistics by-vlan VLANLISTS	This command displays the current statistics by specific VLANs for the PPPoE IA.
enable	configure terminal	This command changes the node to configure node.
configure	clear pppoe intermediate-agent statistics	This command clears the statistics for the PPPoE IA.
configure	clear pppoe intermediate-agent statistics by-vlan VLANLISTS	This command clears the statistics by specific VLANs for the PPPoE IA.

6.17.3.2 Web Configuration

PPPoE IA Statistics

Global Configuration | Port Configuration | **Statistics**

PPPoE IA Statistics

Vlan

Vlan1			<input type="button" value="Clear"/>
PPPoE discovery packet	Received	Forwarded	Dropped
PADI	0	0	0
PADO	0	0	0
PADR	0	0	0
PADS	0	0	0
PADT	0	0	0
Malformed packet	0	0	0

Parameter	Description
PPPoE IA Statistics	
VLAN	Displays the current statistics of the vlan for the PPPoE IA.
PPPoE discovery packet	PPPoE packet type
Received	Total received packet
Forwarded	Total forwarded packet
Dropped	Total dropped packet

Show	Show the statistics of the vlan.
Clear	Clear the statistics of the valn.

6.18 Static Route

Static routes, which define explicit paths between two routers, cannot be automatically updated; you must manually reconfigure static routes when network changes occur. Static routes use less bandwidth than dynamic routes. No CPU cycles are used to calculate and analyze routing updates.

IP forwarding

IP forwarding provides on end to end delivery of IP packet between hosts with help of routers. Routing database plays import role in forwarding the packets. Routers populate its routing database either by manual configurations or by using dynamic routing protocols.

IP forwarding works as router as well as Inter VLAN routing with trunk stick.

Manual routing configurations are called as Static routes. Static routes are permanent routes; we can delete those routes with manual configurations only.

Whenever an IP packet received by a router then it fetches destination IP address and it will do the lookup in routing table to find the longest prefix match route. Packet is forwarded on the assigned next-hop in the route.

6.18.1 CLI configuration

Node	Command	Description
enable	show ip forwarding status	This command displays the current configuration of the ip forwarding status.
enable	show ip routes(all ipv4 ipv6)	This command displays the configurations of IPv4 or IPv6 or both routes from routing table.
enable	show ip arp(all ipv4 ipv6)	This command displays dynamic and static IPv4 or IPv6 or both ARP entries in ARP table.
enable	show ip hosts(all ipv4 ipv6)	This command displays assigned IPv4 or IPv6 or both addresses for interfaces in router.
enable	configure terminal	This command changes the node to configure node.
configure	ip forwarding enable	This command enables layer 3 IPv4 and IPv6 forwarding/routing globally.
configure	no ip forwarding enable	This command disables layer 3 IPv4 and IPv6 forwarding/routing globally. This will delete all assigned IP addresses and static routes from interfaces.
configure	ip arp proxy enable	This command enables route to act as an ARP proxy globally; It will be useful in Inter VLAN routing.
configure	no ip arp proxy enable	This command disables route to act as an ARP proxy.
configure	ipv4 arp <IPv4_ADDR><MAC_ADDR>	This command allows adding static IPv4 ARP entry in ARP table.
configure	ip6 arp	This command allows adding static IPv6 ARP

	<IPv6_ADDR><MAC_ADDR>	entry in ARP table.
configure	no ipv4 arp <IPv4_ADDR><MAC_ADDR>	This command deletes a static IPv4 ARP entry from ARP table.
configure	no ipv6 arp <IPv6_ADDR><MAC_ADDR>	This command deletes a static IPv6 ARP entry from ARP table.
configure	interface vlan VLAN-ID	This command enters the L3 interface node.
L3 interface	ipv4 address A.B.C.D/M	This command assigns a specified IPv4 interface route to the interface. We can assign multiple IPv4 interface route to a single interface with different IP segment. If this configuration is a first IP assigning to the interface then automatically interface is enabled for routing.
L3 interface	ipv6 address <IPv6_ADDR>/M	This command assigns a specified IPv6 interface route to the interface. We can assign only one IPv6 interface route for an interface vlan. If this configuration is a first IP assigning to the interface then it automatically enables the interface with routing.
L3 interface	no ipv4 address A.B.C.D/M	This command deletes a specified IPv4 interface route from the interface vlan. This command deletes all dependent static routes on the specified IPv4 interface route. If there is no assigned IP addresses for the specified interface after deleting then it will automatically disables routing in interface.
L3 interface	no ipv4 address <IPv6_ADDR>/M	This command deletes a specified IPv6 interface route from the interface. This command deletes all dependent static routes on the specified IPv6 interface route. If there is no assigned IP addresses for the specified interface after deleting then it will automatically disables routing in interface vlan.
L3 interface	ipv4 route A.B.C.D/M A.B.C.D	This command configures an IPv4 static route onto the specified interface vlan.
L3 interface	ipv6 route <IPv6_ADDR>/M <IPv6_ADDR>	This command configures an IPv6 static route onto the specified interface vlan.
L3 interface	no ipv4 route A.B.C.D/M A.B.C.D	This command deletes a specified IPv4 static route from an interface vlan.
L3 interface	no ipv6 route <IPv6_ADDR>/M <IPv6_ADDR>	This command deletes a specified IPv6 static route from an interface vlan.

Example:

- IP Forwarding Enable: This command is used to enable ip forwarding (routing).
L2SWITCH(config)#ip forwarding enable

- IP Forwarding Disable: This command is used to disable ip forwarding.
L2SWITCH(config)#no ip forwarding enable
- ARP proxy enable: This command is used to enable ARP proxy.
L2SWITCH(config)#ip arp proxy enable
- ARP proxy disable: This command is used to disable ARP proxy.
L2SWITCH(config)#no ip arp proxy enable
- Add a static IPv4/IPv6 ARP entry: This command is used to add a static IPv4/IPv6 ARP entries.
L2SWITCH(config)#ipv4 arp 192.168.20.1 00:11:22:33:44:55
L2SWITCH(config)#ipv6 arp 1234:ab::ccdd 00:11:22:33:44:55
- Deletes a static IPv4/IPv6 ARP entry: This command is used to delete static IPv4/IPv6 ARP entries
L2SWITCH(config)#no ipv4 arp 192.168.20.1 00:11:22:33:44:55
L2SWITCH(config)#no ipv6 arp 1234:ab::ccdd 00:11:22:33:44:55
- Assigning a IPv4/IPv6 interface router: This command is used to add an IPv4/IPv6 interface route to a interface vlan.
L2SWITCH(config)#interface vlan 1
L2SWITCH(config-if-vlan-13)#
L2SWITCH(config-if-vlan-13)#ipv4 address 192.168.20.1/24
L2SWITCH(config-if-vlan-13)#ipv6 address 1234:ab::ccdd/120
- Deleting IPv4/IPv6 address: This command is used to delete an IPv4/IPv6 interface route from a interface vlan.
L2SWITCH(config-if-vlan-13)#no ipv4 address 192.168.20.1/24
L2SWITCH(config-if-vlan-13)#no ipv6 address 1234:ab::ccdd/120
- Adding static IPv4/IPv6 route: This command is used to add an IPv4/IPv6 static route to a interface vlan.
L2SWITCH(config-if-vlan-13)#ipv4 address 192.168.20.1/24 192.168.20.1
L2SWITCH(config-if-vlan-13)#ipv6 address 1234:ab::ccdd/120 1234:ab::ccdd
- Deleting static IPv4/IPv6 route: This command is used to delete an IPv4/IPv6 static route form an interface vlan.
L2SWITCH(config-if-vlan-13)#no ipv4 address 192.168.20.1/24 192.168.20.1
L2SWITCH(config-if-vlan-13)#no ipv6 address 1234:ab::ccdd/120 1234:ab::ccdd

6.18.2 Web configuration

Static Route

Global Settings

IP Forwarding ▾

IP ARP Proxy ▾

IPv4 ARP Table ▾ IP:

MAC:

IPv6 ARP Table ▾ IP:

MAC:

Route Settings

VLAN:

IPv4 ▾ ▾ IP/M:

Gateway:

IPv6 ▾ ▾ IP/M:

Gateway:

Status

Type: ▾ ▾

Parameter	Description
Global Settings	
IP Forwarding	Enables / disables the IP forwarding globally.
IP ARP Proxy	Enables / disables the route to act as an ARP proxy globally.
IPv4 ARP Table	Adds a static IPv4 ARP entry in the ARP table. / Deletes a static IPv4 ARP entry from the ARP table.
IP	The IP address for the entry.
MAC	The MAC address for the entry.
IPv6 ARP Table	Adds a static IPv6 ARP entry in the ARP table. / Deletes a static IPv6 ARP entry from the ARP table.

IP:	The IP address for the entry.
MAC:	The MAC address for the entry.
Route Settings	
vlan	Specifies an interface vlan.
IPv4	Adds an IPv4 Interface Route / Static Route onto the interface vlan. / Deletes an IPv4 Interface Route / Static Route from the interface vlan. Selects the route type, Interface Route or Static Route.
IP/M:	The IP address and the net mask for the entry.
IP:	The static route address for the Static Route type only.
IPv6	Adds an IPv6 Interface Route / Static Route onto the interface vlan. / Deletes an IPv6 Interface Route / Static Route from the interface vlan. Selects the route type, Interface Route or Static Route.
IP/M:	The IP address and the net mask for the entry.
IP:	The static route address for the Static Route type only.
Apply	Click Apply to take effect the settings.
Refresh	Click Refresh to begin configuring this screen afresh.
Status	
	Shows the ARP table / Host table / Route configurations.

6.19 STP

(R)STP detects and breaks network loops and provides backup links between switches, bridges or routers. It allows a Switch to interact with other (R)STP compliant switches in your network to ensure that only one path exists between any two stations on the network.

The Switch supports Spanning Tree Protocol (STP) and Rapid Spanning Tree Protocol (RSTP) as defined in the following standards.

- IEEE 802.1D Spanning Tree Protocol
- IEEE 802.1w Rapid Spanning Tree Protocol

The Switch uses IEEE 802.1w RSTP (Rapid Spanning Tree Protocol) that allows faster convergence of the spanning tree than STP (while also being backwards compatible with STP-only aware bridges). In RSTP, topology change information is directly propagated throughout the network from the device that generates the topology change. In STP, a longer delay is required as the device that causes a topology change first notifies the root bridge and then the root bridge notifies the network. Both RSTP and STP flush unwanted learned addresses from the filtering database.

In STP, the port states are Blocking, Listening, Learning, Forwarding.

In RSTP, the port states are Discarding, Learning, and Forwarding.

Note: In this document, “STP” refers to both STP and RSTP.

STP Terminology

- The root bridge is the base of the spanning tree.
- Path cost is the cost of transmitting a frame onto a LAN through that port. The recommended cost is assigned according to the speed of the link to which a port is attached. The slower the media, the higher the cost.

	LINK SPEED	RECOMMENDED VALUE	RECOMMENDED RANGE	ALLOWED RANGE
Path Cost	4Mbps	250	100 to 1000	1 to 65535
Path Cost	10Mbps	100	50 to 600	1 to 65535
Path Cost	16Mbps	62	40 to 400	1 to 65535
Path Cost	100Mbps	19	10 to 60	1 to 65535
Path Cost	1Gbps	4	3 to 10	1 to 65535
Path Cost	10Gbps	2	1 to 5	1 to 65535

- On each bridge, the bridge communicates with the root through the root port. The root port is the port on this Switch with the lowest path cost to the root (the root-path cost). If there is no root port, then this Switch has been accepted as the root-bridge of the spanning tree network.
- For each LAN segment, a designated bridge is selected. This bridge has the lowest cost to the root among the bridges connected to the LAN.

Forward Time (Forward Delay):

This is the maximum time (in seconds) the Switch will wait before changing states. This delay is required because every switch must receive information about topology changes before it starts to forward frames. In addition, each port needs time to listen for conflicting information that would make it return to a blocking state; otherwise, temporary data loops might result. The allowed range is 4 to 30seconds.

Max Age:

This is the maximum time (in seconds) the Switch can wait without receiving a BPDU before attempting to reconfigure. All Switch ports(except for designated ports) should receive BPDUs at regular intervals. Any port that age out STP information (provided in the last BPDU) becomes the designated port for the attached LAN. If it is a root port, anew root port is selected from among the Switch ports attached to the network. The allowed range is 6 to 40 seconds.

Hello Time:

This is the time interval in seconds between BPDU (Bridge Protocol Data Units) configuration message generations by the root switch. The allowed range is 1 to 10 seconds.

Path Cost:

Path cost is the cost of transmitting a frame on to a LAN through that port. It is recommended to assign this value according to the speed of the bridge, the slower the media, the higher the cost.

How STP Works?

After a bridge determines the lowest cost-spanning tree with STP, it enables the root port and the ports that are the designated ports for connected LANs, and disables all other ports that participate in STP. Network packets are therefore only forwarded between enabled ports, eliminating any possible network loops.

STP-aware switches exchange Bridge Protocol Data Units (BPDUs) periodically. When the bridged LAN topology changes, a new spanning tree is constructed. Once a stable network topology has been established, all bridges listen for Hello BPDUs (Bridge Protocol Data Units) transmitted from the root bridge. If a bridge does not get a Hello BPDU after a predefined interval (Max Age), the bridge assumes that the link to the root bridge is down. This bridge then initiates negotiations with other bridges to reconfigure the network to re-establish a valid network topology.

802.1D STP

The Spanning Tree Protocol (STP) is a link layer network protocol that ensures a loop-free topology for any bridged LAN. It is based on an algorithm invented by Radia Perlman while working for Digital Equipment Corporation. In the OSI model for computer networking, STP falls under the OSI layer-2. Spanning tree allows a network design to include spare (redundant) links to provide automatic backup paths if an active link fails, without the danger of bridge loops, or the need for manual enabling/disabling of these backup links. Bridge loops must be avoided because they result in flooding the network.

The Spanning Tree Protocol (STP) is defined in the IEEE Standard 802.1D. As the name suggests, it creates a spanning tree within a mesh network of connected layer-2 bridges (typically Ethernet switches), and disables those links that are not part of the tree, leaving a single active path between any two network nodes.

STP switch port states

- Blocking - A port that would cause a switching loop, no user data is sent or received but it may go into forwarding mode if the other links in use were to fail and the spanning tree algorithm determines the port may transition to the forwarding state. BPDU data is still received in blocking state.
- Listening - The switch processes BPDUs and awaits possible new information that would cause it to return to the blocking state.
- Learning - While the port does not yet forward frames (packets) it does learn source addresses from frames received and adds them to the filtering database (switching database)
- Forwarding - A port receiving and sending data, normal operation. STP still monitors incoming BPDUs that would indicate it should return to the blocking state to prevent a loop.
- Disabled - Not strictly part of STP, a network administrator can manually disable a port

802.1w RSTP

In 1998, the IEEE with document 802.1w introduced an evolution of the Spanning Tree Protocol: Rapid Spanning Tree Protocol (RSTP), which provides for faster spanning tree convergence after a topology change. Standard IEEE 802.1D-2004 now incorporates RSTP and obsoletes STP. While STP can take 30 to 50 seconds to respond to a topology change, RSTP is typically able to respond to changes within a second.

RSTP bridge port roles:

- Root - A forwarding port that is the best port from Non-root-bridge to Root-bridge
- Designated - A forwarding port for every LAN segment
- Alternate - An alternate path to the root bridge. This path is different than using the root port.
- Backup - A backup/redundant path to a segment where another bridge port already connects.
- Disabled - Not strictly part of STP, a network administrator can manually disable a port

Edge Port:

They are attached to a LAN that has no other bridges attached. These edge ports transition directly to the forwarding state. RSTP still continues to monitor the port for BPDUs in case a bridge is connected. RSTP can also be configured to automatically detect edge ports. As soon as the bridge detects a BPDU coming to an edge port, the port becomes a non-edge port.

Forward Delay:

The range is from 4 to 30 seconds. This is the maximum time (in seconds) the root device will wait before changing states (i.e., listening to learning to forwarding).

Transmission Limit:

This is used to configure the minimum interval between the transmissions of consecutive RSTP BPDUs. This function can only be enabled in RSTP mode. The range is from 1 to 10 seconds.

Hello Time:

Set the time at which the root switch transmits a configuration message. The range is from 1 to 10 seconds.

Bridge priority:

Bridge priority is used in selecting the root device, root port, and designated port. The device with the highest priority becomes the STA root device. However, if all devices have the same priority, the device with the lowest MAC address will become the root device.

Port Priority:

Set the port priority in the switch. Low numeric value indicates a high priority. A port with lower priority is more likely to be blocked by STP if a network loop is detected. The valid value is from 0 to 240.

Path Cost:

The valid value is from 1 to 200000000. Higher cost paths are more likely to be blocked by STP if a network loop is detected.

BPDU Guard

This is a per port setting. If the port is enabled in BPDU guard and receive any BPDU, the port will be set to disable to avoid the error environments. User must enable the port by manual.

BPDU Filter

It is a feature to filter sending or receiving BPDUs on a switch port. If the port receives any BPDUs, the BPDUs will be dropped.

Notice:

If both of the BPDU filter and BPDU guard are enabled, the BPDU filter has the high priority.

Root Guard

The Root Guard feature forces an interface to become a designated port to prevent surrounding switches from becoming a root switch. In other words, Root Guard provides a way to enforce the root bridge placement in the network. The Root Guard feature prevents a Designated Port from becoming a Root Port. If a port on which the Root Guard feature receives a superior BPDU, it moves the port into a root-inconsistent state (effectively equal to a listening state), thus maintaining the current Root Bridge status. The port can be moved to forwarding state if no superior BPDU received by this port for three hello times.

6.19.1 General Settings

6.19.1.1 CLI Configurations

Node	Command	Description
enable	show spanning-tree active	This command displays the spanning tree information for only active port(s)
enable	show spanning-tree blocked ports	This command displays the spanning tree information for only blocked port(s)
enable	show spanning-tree summary	This command displays the summary of port states and configurations
enable	clear spanning-tree counters	This command clears spanning-tree statistics for all ports.
enable	clear spanning-tree counters PORT_ID	This command clears spanning-tree statistics for a specific port.
enable	configure terminal	This command changes the node to configure node.
configure	spanning-tree (disable enable)	This command disables / enables the spanning tree function for the system.
configure	spanning-tree algorithm-timer forward-time TIME max-age TIME hello-time TIME	This command configures the bridge times(forward-delay, max-age, hello-time).
configure	no spanning-tree algorithm-timer	This command configures the default values for forward-time &max-age &hello-time.
configure	spanning-tree forward-time <4-30>	This command configures the bridge forward delay time (sec).
configure	no spanning-tree forward-time	This command configures the default values for forward-time.
configure	spanning-tree hello-time <1-10>	This command configures the bridge hello time (sec).
configure	no spanning-tree hello-time	This command configures the default values for hello-time.
configure	spanning-tree max-age <6-40>	This command configures the bridge message max-age time (sec).
configure	no spanning-tree max-age	This command configures the default values for max-age time.
configure	spanning-tree mode (rstp stp mst)	This command configures the spanning mode.
configure	spanning-tree path-cost method (short long)	This command configures the path-cost method.
configure	spanning-tree priority <0-61440>	This command configures the priority for the system.
configure	no spanning-tree priority	This command configures the default values for the system priority.

6.19.1.2 Web Configurations

Spanning Tree Protocol

General Settings
Port Parameters
STP Status

Spanning Tree Protocol Settings

State ▾

Mode ▾

Bridge Parameters

Forward Delay (Range:4-30)

Max Age (Range:6-40) Relationships:
 $2 * (\text{Forward Delay} - 1) \geq \text{Max Age}$
 $\text{Max Age} \geq 2 * (\text{Hello Time} + 1)$

Hello Time (Range:1-10)

Priority (Range:0-61440)

Pathcost Method ▾

Parameter	Description
Spanning Tree Protocol Settings	
State	Select Enabled to use Spanning Tree Protocol (STP) or Rapid Spanning Tree Protocol (RSTP).
Mode	Select to use either Spanning Tree Protocol (STP) or Rapid Spanning Tree Protocol (RSTP) or Multiple Spanning Tree Protocol (MSTP).
Forward Time	This is the maximum time (in seconds) the Switch will wait before changing states. This delay is required because every switch must receive information about topology changes before it starts to forward frames. In addition, each port needs time to listen for conflicting information that would make it return to a blocking state; otherwise, temporary data loops might result. The allowed range is 4 to 30seconds.
Max Age	This is the maximum time (in seconds) the Switch can wait without receiving a BPDU before attempting to reconfigure. All Switch ports (except for designated ports) should receive BPDUs at regular intervals. Any port that age out STP information (provided in the last BPDU) becomes the designated port for the attached LAN. If it is a root port, anew root port is selected from among the Switch ports attached to the network. The allowed range is 6 to 40 seconds.
Hello Time	This is the time interval in seconds between BPDU (Bridge Protocol Data Units) configuration message generations by the root switch. The allowed range is 1 to 10 seconds.
Priority	Priority is used in determining the root switch, root port and designated port. The switch with the highest priority (lowest numeric value) becomes the STP

	<p>root switch. If all switches have the same priority, the switch with the lowest MAC address will then become the root switch.</p> <p>Enter a value from 0~61440.</p> <p>The lower the numeric value you assign, the higher the priority for this bridge.</p> <p>Priority determines the root bridge, which in turn determines the Root Hello Time, Root Maximum Age and Root Forwarding Delay.</p>
Path cost	<p>Path cost is the cost of transmitting a frame on to a LAN through that port. It is recommended to assign this value according to the speed of the bridge.</p> <p>The slower the media, the higher the cost.</p>
Apply	Click Apply to take effect the settings.
Refresh	Click Refresh to begin configuring this screen afresh.

6.19.2 Port Parameters

6.19.2.1 CLI Configurations

Node	Command	Description
enable	show spanning-tree blocked ports	This command displays the spanning tree information for only blocked port(s)
enable	show spanning-tree port detail PORT_ID	This command displays the spanning tree information for the interface port.
enable	configure terminal	This command changes the node to configure node.
configure	interface IFNAME	This command enters the interface configure node.
interface	spanning-tree (disable enable)	This command configures enables/disables the STP function for the specific port.
interface	spanning-tree bpdudfilter (disable enable)	This command configures enables/disables the bpdu filter function for the specific port.
interface	spanning-tree bpduguard (disable enable)	This command configures enables/disables the bpdu guard function for the specific port.
interface	spanning-tree rootguard (disable enable)	This command enables/disables the BPDU Root guard port setting for the specific port.
interface	spanning-tree edge-port (disable enable)	This command enables/disables the edge port setting for the specific port.
interface	spanning-tree cost VALUE	<p>This command configures the cost for the specific port.</p> <p>Cost range:</p> <p>16-bit based value range 1-65535, 32-bit based value range 1-200000000.</p>
interface	no spanning-tree cost	This command configures the path cost to default for the specific port.
interface	spanning-tree port-priority <0-240>	<p>This command configures the port priority for the specific port.</p> <p>Default: 128.</p>

interface	no spanning-tree port-priority	This command configures the port priority to default for the specific port.
configure	interface range gigabitethernet1/0/PORTLISTS	This command enters the if-range configure node.
if-range	spanning-tree(disable enable)	This command configures enables/disables the STP function for the specific port.
if-range	spanning-tree bpdudfilter (disable enable)	This command configures enables/disables the bpdu filter function for the specific port.
if-range	spanning-tree bpduguard (disable enable)	This command configures enables/disables the bpdu guard function for the specific port.
if-range	spanning-tree rootguard (disable enable)	This command enables/disables the BPDU Root guard port setting for the specific port.
if-range	spanning-tree edge-port (disable enable)	This command enables/disables the edge port setting for the specific port.
if-range	spanning-tree cost VALUE	This command configures the cost for the specific port. Cost range: 16-bit based value range 1-65535, 32-bit based value range 1-200000000.
if-range	no spanning-tree cost	This command configures the path cost to default for the specific port.
if-range	spanning-tree port-priority <0-240>	This command configures the port priority for the specific port. Default: 128.
if-range	no spanning-tree port-priority	This command configures the port priority to default for the specific port.

6.19.2.2 Web Configurations

Spanning Tree Protocol

General Settings
Port Parameters
STP Status

STP Port Settings

Port	Active	Path Cost	Priority	Edge Port	BPDU Filter	BPDU Guard	ROOT Guard
From: <input type="text" value="1"/> To: <input type="text" value="1"/>	<input type="text" value="Enable"/>	<input type="text" value="250"/>	<input type="text" value="128"/>	<input type="text" value="Disable"/>	<input type="text" value="Disable"/>	<input type="text" value="Disable"/>	<input type="text" value="Disable"/>

STP Port Status

Port	Active	Role	Status	Path Cost	Priority	Edge Port	BPDU Filter	BPDU Guard	ROOT Guard
1	Enabled	None	Discarding	250	128	Disabled	Disabled	Disabled	Disabled
2	Enabled	None	Discarding	250	128	Disabled	Disabled	Disabled	Disabled
3	Enabled	None	Discarding	250	128	Disabled	Disabled	Disabled	Disabled
4	Enabled	None	Discarding	250	128	Disabled	Disabled	Disabled	Disabled
5	Enabled	None	Discarding	250	128	Disabled	Disabled	Disabled	Disabled
6	Enabled	None	Discarding	250	128	Disabled	Disabled	Disabled	Disabled
7	Enabled	None	Discarding	250	128	Disabled	Disabled	Disabled	Disabled
8	Enabled	None	Discarding	250	128	Disabled	Disabled	Disabled	Disabled
9	Enabled	None	Discarding	250	128	Disabled	Disabled	Disabled	Disabled
10	Enabled	None	Discarding	250	128	Disabled	Disabled	Disabled	Disabled
11	Enabled	None	Discarding	250	128	Disabled	Disabled	Disabled	Disabled
12	Enabled	None	Discarding	250	128	Disabled	Disabled	Disabled	Disabled

Parameter	Description
STP Port Settings	
Port	Selects a port that you want to configure.
Active	Enables/Disables the spanning tree function for the specific port.
Path Cost	Configures the path cost for the specific port.
Priority	Configures the priority for the specific port.
Edge Port	Configures the port type for the specific port. Edge or Non-Edge.
BPDU Filter	Enables/Disables the BPDU filter function for the specific port.
BPDU Guard	Enables/Disables the BPDU guard function for the specific port.
ROOT Guard	Enables/Disables the BPDU root guard function for the specific port.
Apply	Click Apply to take effect the settings.

Refresh	Click Refresh to begin configuring this screen afresh.
STP Port Status	
Active	The state of the STP function.
Role	The port role. Should be one of the Alternated / Designated / Root / Backup / None.
Status	The port's status. Should be one of the Discarding / Blocking / Listening / Learning / Forwarding / Disabled.
Path Cost	The port's path cost.
Priority	The port's priority.
Edge Port	The state of the edge function.
BPDU Filter	The state of the BPDU filter function.
BPDU Guard	The state of the BPDU guard function.
ROOT Guard	The state of the BPDU Root guard function.

6.19.3 STP Status

6.19.3.1 Web Configurations

Spanning Tree Protocol

General Settings | Port Parameters | **STP Status**

Current Root Status

MAC Address	Priority	Max Age	Hello Time	Forward Delay
00:0b:04:90:60:21	32768	20	2	15

Current Bridge Status

MAC Address	Priority	Max Age	Hello Time	Forward Delay	Path Cost	Root Port
00:0b:04:90:60:21	32768	20	2	15	0	0

Parameter	Description
Current Root Status	
MAC address	This is the MAC address of the root bridge.
Priority	Root refers to the base of the spanning tree (the root bridge). This field displays the root bridge's priority. This Switch may also be the root bridge.
MAX Age	This is the maximum time (in seconds) the Switch can wait without receiving a configuration message before attempting to reconfigure.
Hello Time	This is the time interval (in seconds) at which the root switch transmits a configuration message. The root bridge determines Hello Time, Max Age and Forwarding Delay.
Forward Delay	This is the time (in seconds) the root switch will wait before changing states.
Refresh	Click Refresh to begin configuring this screen afresh.
Current Bridge Status	
MAC address	This is the MAC address of the current bridge.
Priority	Priority is used in determining the root switch, root port and designated port. The switch with the highest priority (lowest numeric value) becomes the STP root switch. If all switches have the same priority, the switch with the lowest MAC address will then become the root switch. Priority determines the root bridge, which in turn determines the Root Hello Time, Root Maximum Age and Root Forwarding Delay.
MAX Age	This is the maximum time (in seconds) the Switch can wait without receiving a BPDU before attempting to reconfigure. All Switch ports

	(except for designated ports) should receive BPDUs at regular intervals. Any port that age out STP information (provided in the last BPDU) becomes the designated port for the attached LAN. If it is a root port, a new root port is selected from among the Switch ports attached to the network.
Hello Time	This is the time interval in seconds between BPDU (Bridge Protocol Data Units) configuration message generations by the root switch.
Forward Delay	This is the maximum time (in seconds) the Switch will wait before changing states. This delay is required because every switch must receive information about topology changes before it starts to forward frames. In addition, each port needs time to listen for conflicting information that would make it return to a blocking state; otherwise, temporary data loops might result.
Path Cost	Path cost is the cost of transmitting a frame on to a LAN through that port. It is recommended to assign this value according to the speed of the bridge. The slower the media, the higher the cost.
Root Cost	This is the number of the port on the Switch through which this Switch must communicate with the root of the Spanning Tree.

6.19.4 MSTP

MSTP (IEEE 802.1S Multiple STP), which uses RSTP for rapid convergence, enables VLANs to be grouped into a spanning-tree instance, with each instance having a spanning-tree topology independent of other spanning-tree instances. This architecture provides multiple forwarding paths for data traffic, enables load balancing, and reduces the number of spanning-tree instances required to support a large number of VLANs.

Multiple Spanning-Tree Regions:

For switches to participate in multiple spanning-tree (MST) instances, you must consistently configure the switches with the same MST configuration information. A collection of interconnected switches that have the same MST configuration comprises an MST region. The MST configuration determines to which MST region each switch belongs. The configuration includes the name of the region, the revision number, and the MST instance-to-VLAN assignment map. You configure the switch for a region by using the spanning-tree mst configuration global configuration command, after which the switch enters the MST configuration mode. From this mode, you can map VLANs to an MST instance by using the instance MST configuration command, specify the region name by using the name MST configuration command, and set the revision number by using the revision MST configuration command.

A region can have one member or multiple members with the same MST configuration; each member must be capable of processing RSTP BPDUs. There is no limit to the number of MST regions in a network, but each region can support up to 16 spanning-tree instances. You can assign a VLAN to only one spanning-tree instance at a time.

Boundary Ports

A boundary port is a port that connects an MST region to a single spanning-tree region running RSTP, or to a single spanning-tree region running 802.1D, or to another MST region with a different MST configuration. A boundary port also connects to a LAN, the designated switch of which is either a single spanning-tree switch or a switch with a different MST configuration.

At the boundary, the roles of the MST ports do not matter, and their state is forced to be the same as the IST port state (MST ports at the boundary are in the forwarding state only when the IST port is forwarding). An IST port at the boundary can have any port role except a backup port role.

On a shared boundary link, the MST ports wait in the blocking state for the forward-delay time to expire before transitioning to the learning state. The MST ports wait another forward-delay time before transitioning to the forwarding state.

- If the boundary port is on a point-to-point link and it is the IST root port, the MST ports transition to the forwarding state as soon as the IST port transitions to the forwarding state.
- If the IST port is a designated port on a point-to-point link and if the IST port transitions to the forwarding state because of an agreement received from its peer port, the MST ports also immediately transition to the forwarding state.
- If a boundary port transitions to the forwarding state in an IST instance, it is forwarding in all MST instances, and a topology change is triggered. If a boundary port with the IST root or designated port role receives a topology change notice external to the MST cloud, the MSTP switch triggers a topology change in the IST instance and in all the MST instances active on that port.

Interoperability with 802.1D STP:

A switch running MSTP supports a built-in protocol migration mechanism that enables it to interoperate with legacy 802.1D switches. If this switch receives a legacy 802.1D configuration BPDU (a BPDU with the protocol version set to 0), it sends only 802.1D BPDUs on that port. An MSTP switch can also detect that a port is at the boundary of a region when it receives a legacy BPDU, an MSTP BPDU (version 3) associated with a different region, or an RSTP BPDU (version 2).

However, the switch does not automatically revert to the MSTP mode if it no longer receives 802.1DBPDUs because it cannot determine whether the legacy switch has been removed from the link unless the legacy switch is the designated switch. Also, a switch might continue to assign a boundary role to a port when the switch to which this switch is connected has joined the region. To restart the protocol migration process (force the renegotiation with neighboring switches), you can use the clear spanning-tree detected-protocols privileged EXEC command.

If all the legacy switches on the link are RSTP switches, they can process MSTP BPDUs as if they are RSTP BPDUs. Therefore, MSTP switches send either a version 0 configuration and TCN BPDUs or version 3 MSTP BPDUs on a boundary port. A boundary port connects to a LAN, the designated switch of which is either a single spanning-tree switch or a switch with a different MST configuration.

Specifying the MST Region Configuration and Enabling MSTP

For two or more switches to be in the same MST region, they must have the same VLAN-to-instance mapping, the same configuration revision number, and the same name. A region can have one member or multiple members with the same MST configuration; each member must be capable of processing RSTP BPDUs. There is no limit to the number of MST regions in a network, but each region can support up to 16 spanning-tree instances. You can assign a VLAN to only one spanning-tree instance at a time.

6.19.4.1 General Settings

6.19.4.1.1 CLI Configurations

Node	Command	Description
enable	show spanning-tree mst configuration	This command displays the MSTP configurations.
enable	show spanning-tree mst instance	This command displays all of the instance configurations of the MSTP.
enable	show spanning-tree mst instance <0-63>	This command displays specific instance configurations of the MSTP.
enable	show spanning-tree mst instance <0-63>interface IFNAME	This command displays specific instance configurations on an interface of the MSTP.
enable	show spanning-tree mst interface IFNAME	This command displays the configurations on an interface of the MSTP.
enable	configure terminal	This command changes the node to configure node.
configure	spanning-tree (disable enable)	This command enables / disables the spanning tree.
configure	spanning-tree mode mst	This command configures the mode of the spanning tree. (one of the three modes STP/RSTP/MSTP.)
configure	spanning-tree mst instance STRING priority <0-61440>	This command configures the instance name and priority. The priority must be the multiple value of 4096.
configure	no spanning-tree mst instance STRING priority	This command resets the priority for the specific instance. The default priority is 32768.
configure	spanning-tree mst configuration	This command enters the MSTP configure node.
configure	no spanning-tree mst configuration	This command resets all of configurations for the MSTP.
mst	apply	This command applies configurations to current instant.
mst	Instance <1-63> vlan VLANLIST	This command configures the instance and vlan map. The target vlan number(ex.10) or range(ex.1-10).
mst	name	This command configures a region name for the MSTP.
mst	no name	This command reset the region name for the MSTP.

mst	revision	This command configures the revision for the MSTP.
mst	no revision	This command resets the revision for the MSTP.
mst	show (current pending)	This command shows the MSTP configures. Current – the working configurations. Pending – the not applied configurations.

6.19.4.1.2 Web Configurations

Spanning Tree Protocol

General Settings
Bridge Parameters
Port Parameters
STP Status

STP Global Settings

State

Mode

Parameters and Instance Settings

Region Name

Revision (Range:0-65535)

Instance

Priority (Range:0-61440)

VLAN

Instance	VLAN	Priority	Action
0	1,3-4094	32768	
1	2	0	<input type="button" value="Delete"/>

Parameter	Description
STP Global Settings	
State	Select Enabled to use Spanning Tree Protocol (STP) or Rapid Spanning Tree Protocol (RSTP) or Multiple Spanning Tree Protocol (MSTP).
Mode	Selects the Spanning Tree running mode. STP - Spanning Tree Protocol. RSTP - Rapid Spanning Tree Protocol. MSTP - Multiple Spanning Tree Protocol.
Configuration Parameters	
Region Name	Configures the region name for the Switch.
Revision	Configures the revision for the Switch.
Instance	Selects an instance which you want to configure.
Priority	Configures the priority for the instance. Priority is used in determining the root switch, root port and designated port. The switch with the highest priority (lowest numeric value) becomes the STP root switch. If all switches have the same

	<p>priority, the switch with the lowest MAC address will then become the root switch. Enter a value from 0~61440.</p> <p>The lower the numeric value you assign, the higher the priority for this bridge.</p> <p>Priority determines the root bridge, which in turn determines the Root Hello Time, Root Maximum Age and Root Forwarding Delay.</p>
VLAN	<p>Select one or more vlans which will join the instance.</p> <p>Note: the vlan will be removed from instance 0 automatically.</p>
Apply	Click Apply to take effect the settings.
Refresh	Click Refresh to begin configuring this screen afresh.

Instance and vlan map table

Instance	The instance.
VLAN	The vlan in the instance.
Priority	The field displays the priority for the instance.
Action	Click Delete button to delete this instance.

6.19.4.2 Bridge Parameters

6.19.4.2.1 CLI Configurations

Node	Command	Description
enable	show spanning-tree mst configuration	This command displays the MSTP configurations.
enable	show spanning-tree mst instance <0-63> interface IFNAME	This command displays specific instance configurations on an interface of the MSTP.
enable	configure terminal	This command changes the node to configure node.
configure	spanning-tree mst forward-time <4-30>	This command configures the forward time for the MSTP.
configure	no spanning-tree mst forward-time	This command resets the forward time for the MSTP. The default forward delay time is 15 seconds.
configure	spanning-tree mst hello-time <1-10>	This command configures the hello time for the MSTP.
configure	no spanning-tree mst hello-time	This command resets the hello time for the MSTP. The default hello time is 2 seconds.
configure	spanning-tree mst max-age <6-40>	This command configures the maximum age time for the MSTP.
configure	no spanning-tree mst max-age	This command resets the maximum age time for the MSTP.

		The default maximum age time is 20 seconds.
configure	spanning-tree mst max-hops <1-40>	This command configures the maximum hop count.
configure	no spanning-tree mst max-hops	This command resets the maximum hop count. The default maximum hop count is 20.

6.19.4.2.2 Web Configurations

Spanning Tree Protocol

General Settings
Bridge Parameters
Port Parameters
STP Status

Bridge Parameters Settings

Forward Time	<input type="text" value="15"/>	(Range:4-30)
Hello Time	<input type="text" value="2"/>	(Range:1-10)
Max Age	<input type="text" value="20"/>	(Range:6-40)
Max Hops	<input type="text" value="20"/>	(Range:1-40)

Parameter	Description
Bridge Parameters Settings	
Forward Time	This is the maximum time (in seconds) the Switch will wait before changing states. This delay is required because every switch must receive information about topology changes before it starts to forward frames. In addition, each port needs time to listen for conflicting information that would make it return to a blocking state; otherwise, temporary data loops might result. The allowed range is 4 to 30seconds.
Hello Time	This is the time interval in seconds between BPDU (Bridge Protocol Data Units) configuration message generations by the root switch. The allowed range is 1 to 10 seconds.
Max Age	This is the maximum time (in seconds) the Switch can wait without receiving a BPDU before attempting to reconfigure. All Switch ports (except for designated ports) should receive BPDUs at regular intervals. Any port that age out STP information (provided in the last BPDU) becomes the designated port for the attached LAN. If it is a root port, anew root port is selected from among the Switch ports attached to the network. The allowed range is 6 to 40 seconds.
Max Hops	Select the maximum hopes and the allowed range is from 1 to 40

Apply	Click Apply to take effect the settings.
Refresh	Click Refresh to begin configuring this screen afresh.

6.19.4.3 Port Parameters

6.19.4.3.1 CLI Configurations

Node	Command	Description
enable	show spanning-tree mst interface IFNAME	This command displays the configurations on an interface of the MSTP.
enable	configure terminal	This command changes the node to configure node.
configure	interface IFNAME	This command enters the interface configure node.
interface	spanning-tree mst instance STRING cost <1-200000000>	This command configures a cost on the specific port for the MSTP.
interface	no spanning-tree mst instance STRING cost	This command resets the cost on the specific port for the MSTP.
interface	spanning-tree mst instance STRING port-priority <0-240>	This command configures a priority on the specific port for the MSTP.
interface	no spanning-tree mst instance STRING port-priority	This command resets the priority on the specific port for the MSTP.
interface	spanning-tree (disable enable)	This command configures enables/disables the STP function for the specific port.
interface	spanning-tree bpdufilter (disable enable)	This command configures enables/disables the bpdu filter function for the specific port.
interface	spanning-tree bpduguard (disable enable)	This command configures enables/disables the bpdu guard function for the specific port.
interface	spanning-tree rootguard (disable enable)	This command enables/disables the BPDU Root guard port setting for the specific port.
interface	spanning-tree edge-port (disable enable)	This command enables/disables the edge port setting for the specific port.
interface	spanning-tree cost VALUE	This command configures the cost for the specific port. Cost range: 16-bit based value range 1-65535, 32-bit based value range 1-200000000.
interface	no spanning-tree cost	This command configures the path cost to default for the specific port.
interface	spanning-tree port-priority <0-240>	This command configures the port priority for the specific port. Default: 128.
interface	no spanning-tree port-priority	This command configures the port priority to default for the specific port.
configure	interface range gigabitethernet1/0/PORTLISTS	This command enters the if-range configure node.
if-range	spanning-tree (disable enable)	This command configures enables/disables the

		STP function for the specific port.
if-range	spanning-tree bpdufilter (disable enable)	This command configures enables/disables the bpdu filter function for the specific port.
if-range	spanning-tree bpduguard (disable enable)	This command configures enables/disables the bpdu guard function for the specific port.
if-range	spanning-tree rootguard (disable enable)	This command enables/disables the BPDU Root guard port setting for the specific port.
if-range	spanning-tree edge-port (disable enable)	This command enables/disables the edge port setting for the specific port.
if-range	spanning-tree cost VALUE	This command configures the cost for the specific port. Cost range: 16-bit based value range 1-65535, 32-bit based value range 1-200000000.
if-range	no spanning-tree cost	This command configures the path cost to default for the specific port.
if-range	spanning-tree port-priority <0-240>	This command configures the port priority for the specific port. Default: 128.
if-range	no spanning-tree port-priority	This command configures the port priority to default for the specific port.

6.19.4.3.2 Web Configurations

Spanning Tree Protocol

General Settings
Bridge Parameters
Port Parameters
STP Status

Port Parameters Settings

Instance	Port	Path Cost	Priority
0 ▾	From: 1 ▾ To: 1 ▾	200000000	128

Port	Active	Edge Port	BPDU Filter	BPDU Guard	ROOT Guard
From: 1 ▾ To: 1 ▾	Enable ▾	Disable ▾	Disable ▾	Disable ▾	Disable ▾

Port Status

Port	Active	Role	Status	Path Cost	Priority	Edge Port	BPDU Filter	BPDU Guard	ROOT Guard
1	Enabled	Disabled	Blocking	200000000	128	Disabled	Disabled	Disabled	Disabled
2	Enabled	Disabled	Blocking	200000000	128	Disabled	Disabled	Disabled	Disabled
3	Enabled	Disabled	Blocking	200000000	128	Disabled	Disabled	Disabled	Disabled
4	Enabled	Disabled	Blocking	200000000	128	Disabled	Disabled	Disabled	Disabled
5	Enabled	Disabled	Blocking	200000000	128	Disabled	Disabled	Disabled	Disabled
6	Enabled	Disabled	Blocking	200000000	128	Disabled	Disabled	Disabled	Disabled
7	Enabled	Disabled	Blocking	200000000	128	Disabled	Disabled	Disabled	Disabled
8	Enabled	Disabled	Blocking	20000	128	Disabled	Disabled	Disabled	Disabled
9	Enabled	Disabled	Blocking	200000000	128	Disabled	Disabled	Disabled	Disabled
10	Enabled	Disabled	Blocking	200000000	128	Disabled	Disabled	Disabled	Disabled
11	Enabled	Disabled	Blocking	200000000	128	Disabled	Disabled	Disabled	Disabled
12	Enabled	Disabled	Blocking	200000000	128	Disabled	Disabled	Disabled	Disabled

Parameter	Description
STP Port Settings	
Instance	Selects an instance that you want to configure.
Port	Selects a port or a range of ports that you want to configure.
Path Cost	Configures the path cost for the specific port.
Priority	Configures the priority for the specific port.
Port	Selects a port or a range of ports that you want to configure.
Active	Enables/Disables the spanning tree function for the specific port.
Edge Port	Configures the port type for the specific port. Edge or Non-Edge.

BPDU Filter	Enables/Disables the BPDU filter function for the specific port.
BPDU Guard	Enables/Disables the BPDU guard function for the specific port.
ROOT Guard	Enables/Disables the BPDU root guard function for the specific port.
Apply	Click Apply to take effect the settings.
Refresh	Click Refresh to begin configuring this screen afresh.
STP Port Status	
Active	The state of the STP function.
Role	The port role. Should be one of the Alternated / Designated / Root / Backup / None.
Status	The port's status. Should be one of the Discarding / Blocking / Listening / Learning / Forwarding / Disabled.
Path Cost	The port's path cost.
Priority	The port's priority.
Edge Port	The state of the edge function.
BPDU Filter	The state of the BPDU filters function.
BPDU Guard	The state of the BPDU guards function.
ROOT Guard	The state of the BPDU Root guard function.

6.19.4.4 STP Status

6.19.4.4.1 CLI Configurations

Node	Command	Description
enable	show spanning-tree mst root	This command displays the root bridge configurations.

6.19.4.4.2 Web Configurations

Spanning Tree Protocol

General Settings
Bridge Parameters
Port Parameters
STP Status

Current Root Status

Instance	MAC Address	Priority	Root Cost	Max Age	Hello Time	Forward Delay	Root Port
0	00:0b:04:90:60:21	32768	0	20	2	15	0
1	00:0b:04:90:60:21	32768	0	20	2	15	0

Current Bridge Status

Instance	MAC Address	Priority
0	00:0b:04:90:60:21	32768
1	00:0b:04:90:60:21	32768

Parameter	Description
Current Root Status	
Instance	The Instance ID.
MAC address	This is the MAC address of the root bridge.
Priority	Root refers to the base of the spanning tree (the root bridge). This field displays the root bridge's priority. This Switch may also be the root bridge.
Root Cost	This is the path cost to the root bridge.
MAX Age	This is the maximum time (in seconds) the Switch can wait without receiving a configuration message before attempting to reconfigure.
Hello Time	This is the time interval (in seconds) at which the root switch transmits a configuration message. The root bridge determines Hello Time, Max Age and Forwarding Delay.
Forward Delay	This is the time (in seconds) the root switch will wait before changing states.
Root Port	This is the port to the root bridge.

Current Bridge Status	
Instance	This is the MAC address of the current bridge.
MAC address	This is the MAC address of the bridge.
Priority	This is the priority of the Switch.
Refresh	Click Refresh to begin configuring this screen afresh.

6.20 UDLD

The UDLD (UniDirectional Link Detection) protocol is used to detect and/or disable unidirectional connections before they create dangerous situations such as Spanning Tree loops or other protocol malfunctions.

The UDLD protocol was implemented to help correct certain assumptions made by other protocols and in particular to help the STP to function properly so as to avoid the creation of dangerous Layer 2 loops.

UDLD is meant to be a Layer 2 detection protocol that works on top of existing Layer 1 detection mechanisms defined by the IEEE standards.

Network systems typically check for miss wiring or unidirectional problems at the physical layer. The physical layer defines the actual physical components such as connectors and cables. So, physical layer only checks for open lines or port malfunctions and would not detect a miss wired systems.

But, UDLD performs mutual neighbor identification; in addition, it performs neighbor acknowledgement on top of the Logical Link Control (LLC) layer and thus is able to discover logical one-way miscommunication between neighbors even when either one of PHY layer mechanisms has deemed the transmission medium bidirectional.

6.20.1 Port Settings

6.20.1.1 CLI Configurations

Node	Command	Description
enable	show udld status	This command displays the UDLD global settings.
enable	show udld port-status	This command displays the ports' settings.
enable	show udld neighbor	This command displays the port's neighbor information.
enable	configure terminal	This command changes the node to configure node.
config	udld enable	This command enables the global UDLD state.
config	no udld enable	This command disables the global UDLD state.
config	udld message interval-time <1-90>	This command configures the interval time of sending . (unit: second).
config	udld message interval-time reset	This command configures the interval time to default value. (7 seconds)
configure	interface IFNAME	This command enters the interface configure node.
interface	udld port enable	This command enables the udld state for the specific port.

interface	no udld port enable	This command disables the udld state for the specific port.
interface	udld port aggressive	This command configures the udld mode to aggressive mode for the specific port.
interface	no udld port aggressive	This command configures the udld mode to normal mode for the specific port.

Case 1: To configure UDLD on port 1 only then disable udld port configuration on all interfaces except port 1 and enable global UDLD.

```
L2SWITCH#configure terminal
L2SWITCH(config)# interface <id> //All interfaces one by one except port 1
L2SWITCH(config-if)# no udld port enable
L2SWITCH(config-if)# exit
L2SWITCH(config)# udld enable
```

Case 2: To configure UDLD on all ports

```
L2SWITCH#configure terminal
L2SWITCH(config)# udld enable
```

Case 3: To disable UDLD on all ports

```
L2SWITCH#configure terminal
L2SWITCH(config)# no udld enable
```

Case 4: To disable UDLD on a specific port; example port 1

```
L2SWITCH#configure terminal
L2SWITCH(config)# interface <port_1>
L2SWITCH(config-if)# no udld port enable
```

Case 5: To enable aggressive mode on a specific port; example port 1

```
L2SWITCH#configure terminal
L2SWITCH(config)# interface <port_1>
L2SWITCH(config-if)# udld port aggressive
```

Case 6: To disable aggressive mode on a specific port; example port 1

```
L2SWITCH#configure terminal
L2SWITCH(config)# interface <port_1>
L2SWITCH(config-if)# no udld port aggressive
```

Display Commands:

```
L2SWITCH#show udld status
```

```
UDLD state : enabled.
UDLD message interval time : 7 seconds.
UDLD neighbor expiry time : 35 seconds
```

It displays UDLD global configuration, message interval time and neighbor hold time.

```
L2SWITCH#show udld neighbors
```

Port	Device Name	Device ID	Port ID	Time	Status
----	-----	-----	-----	---	-----

1	L2SWITCH	005043717AAA	Fa1/0/1	32	Active
4	L2SWITCH	005043717AAB	Fa1/0/3	31	Active

1. Show udd neighbor displays received neighbor information in the switch.
2. Device name is as same as the hostname of the switch, from where neighbor information received.
3. Device ID is as same as cpu port's MAC address of the switch, from where neighbor information received.
4. Port ID is provided Port speed and port number in the switch, from where neighbor information received.
5. Time field is expiry timer of the neighbor entry; It will get refreshed whenever it receives a neighbor information advertisement.
6. Status shows
 - a. Active: If neighbor is participating in advertisement and it last refreshed time is less than message interval time. So, it is actively updating from the connected switch.
 - b. Inactive: Last refreshment of neighbor information is more than message time interval. It is getting updated actively from connected switch.

6.20.1.2 Web Configurations

UDLD

Port Settings
Neighbors

Port Settings

State ▾

Message Time Interval seconds (Range: 1~90)

Recovery Interval seconds (0-No Recovery, Range: 30~86400)

Port	State	Aggressive
From: <input type="text" value="1"/> ▾ To: <input type="text" value="1"/> ▾	<input type="text" value="Enable"/> ▾	<input type="text" value="Disable"/> ▾

Port Status

Port	State	Aggressive	Detection State	Operational State
1	Enable	Disabled	Unknown	UDLD Down
2	Enable	Disabled	Unknown	UDLD Down
3	Enable	Disabled	Unknown	UDLD Down
4	Enable	Disabled	Unknown	UDLD Down
5	Enable	Disabled	Unknown	UDLD Down
6	Enable	Disabled	Unknown	UDLD Down
7	Enable	Disabled	Unknown	UDLD Down
8	Enable	Disabled	Unknown	UDLD Down
9	Enable	Disabled	Unknown	UDLD Down
10	Enable	Disabled	Unknown	UDLD Down
11	Enable	Disabled	Unknown	UDLD Down
12	Enable	Disabled	Unknown	UDLD Down

Parameter	Description
Port Settings	
State	Selects Enable or Disable to enable or disable the global UDLD state.
Message Interval Time	Configures the message interval time.
Port	Selects a port or a range of ports to be configured.
State	Selects the port state for above selection.
Aggressive	Selects enable to let the port working in Aggressive mode. Selects disable to let the port working in Normal mode.

Apply	Click Apply to take effect the settings.
Refresh	Click Refresh to begin configuring this screen afresh.
Port Status	
State	Display the current UDLD port state for the specific port.
Aggressive	Display the current Aggressive state for the specific port.
Bidirectional State	Display the current detection state.
Operational State	Display the current operational state.

6.20.2 Neighbors

6.20.2.1 CLI Configurations

Node	Command	Description
enable	show udld neighbor	This command displays the port's neighbor information.

6.20.2.2 Web Configurations

UDLD

Port Settings **Neighbors**

Neighbor Information

No UDLD Neighbors

Parameter	Description
Neighbor Information	
Select Port	Selects Enable or Disable to enable or disable the global UDLD state.
Port	The local port number.
Device Name	The device name of the neighbor Switch.
Device ID	The device ID of the neighbor Switch.
Port ID	The port number of the neighbor Switch connected to this port.
Neighbor State	The operational state of the neighbor Switch.

Refresh

Click **Refresh** to begin configuring this screen afresh.

6.21 Xpress Ring

The Xpress-Ring is a fast-acting, self-healing ring recovery technology that enables networks to recover from link failure within 10ms.

Fast Link Recovery and Ring Redundancy are important features for increasing the reliability of non-stop systems.

If the network is planned correctly with an arbiter Switch and ring ports, the network will recover from any segment failure within a very short time.

There are two roles (Forwarder and Arbiter) of the Switch in the Xpress-Ring. There is one and only one Switch is the Arbiter Switch and the others are the forwarder Switch.

One of the ring ports of the Arbiter Switch will be set to blocking state. When one of the ring connections is broken, the blocked port will be set to forwarding state.

Notices

- An Xpress Ring can have one Arbiter only.
- A Switch can join one or two Xpress Ring.
- Every Switch can be a Forwarder or Arbiter in an Xpress Ring.
- The two adjacent Xpress Rings should not use a same destination multicast MAC.
- If you want to enable the STP (RSTP) and Xpress Ring on a Switch, you should disable the STP (RSTP) on the Xpress Ring's member ports.
- If you want to enable the Loop Detection and Xpress Ring on a Switch, you should disable the Loop Detection on the Xpress Ring's member ports.
- If you want to enable the Broadcast Storm and Xpress Ring on a Switch, you should disable the Broadcast Storm on the Xpress Ring's member ports.
- If there are old devices (for example: INS-803A) to join the Xpress-Ring, they can join as a forwarder only.

6.21.1 CLI Configuration

Node	Command	Description
enable	show xpress-ring	This command displays the current Xpress-Ring configurations.
enable	configure terminal	This command changes the node to configure node.
configure	xpress-ring(disable enable)	This command enables/disables the Xpress-Ring on the Switch.
configure	xpress-ring ring (RING1 RING2) state (disable enable)	This command enables/disables the ring on the Switch.
configure	xpress-ring ring (RING1 RING2)	This command configures the last byte of the destination MAC for the ring on the Switch.

	last-byte-destination-mac VALUE	
configure	xpress-ring ring (RING1 RING2) role (forwarder arbiter)	This command configures the role (forwarder/arbiter) for the ring on the Switch.
configure	xpress-ring ring (RING1 RING2) primary-port PORTID	This command configures the primary port for the ring on the Switch. <i>Notice: If the global xpress ring is disabled or ring state is disabled, you can input 0 to reset the primary port.</i>
configure	xpress-ring ring (RING1 RING2) secondary-port PORTID	This command configures the secondary port for the ring on the Switch. <i>Notice: If the global xpress ring is disabled or ring state is disabled, you can input 0 to reset the primary port.</i>

6.21.2 Web Configuration

Xpress Ring

Xpress Ring Settings

Global State : Disable ▾

	Ring1	Ring2
State	Disable ▾	Disable ▾
Destination MAC(Last byte)	f0	f1
Role	Forwarder ▾	Forwarder ▾
Primary Port	None ▾	None ▾
Secondary Port	None ▾	None ▾

Apply
Refresh

Xpress Ring Status

	Ring1	Ring2
State	Disabled	Disabled
Destination MAC	01:80:c2:ff:ff:f0	01:80:c2:ff:ff:f1
Role	Forwarder	Forwarder
Primary Port	N/A (No connection)	N/A (No connection)
Secondary Port	N/A (No connection)	N/A (No connection)

Parameter	Description
Xpring Ring Settings	
Global State	Enables/Disable the global Xpress ring function.

State	Enables / Disables the ring state.
Destination MAC(Last byte)	Configures the last byte of the destination MAC for the ring.
Role	Configures the role for the ring.
Primary Port	Configures the primary port for the ring.
Secondary Port	Configure the secondary port for the ring.
Apply	Click Apply to take effect the settings.
Refresh	Click Refresh to begin configuring this screen afresh.
Xpress Ring Status	
State	The current state of the ring.
Destination MAC	The destination MAC for the ring.
Role	The current role of the ring.
Primary Port	The current primary port and its status.
Secondary Port	The current secondary port and its status.

7 Security

7.4 Security

7.4.1 IP Source Guard

IP Source Guard is a security feature that restricts IP traffic on un-trusted Layer 2 ports by filtering traffic based on the DHCP snooping binding database or manually configured IP source bindings. This feature helps prevent IP spoofing attacks when a host tries to spoof and use the IP address of another host. Any IP traffic coming into the interface with a source IP address other than that assigned (via DHCP or static configuration) will be filtered out on the un-trusted Layer 2 ports.

The IP Source Guard feature is enabled in combination with the DHCP snooping feature on un-trusted Layer 2 interfaces. It builds and maintains an IP source binding table that is learned by DHCP snooping or manually configured (static IP source bindings). An entry in the IP source binding table contains the IP address and the associated MAC and VLAN numbers. The IP Source Guard is supported on Layer 2 ports only, including access and trunk ports.

The IP Source Guard features include below functions:

1. DHCP Snooping.
2. DHCP Binding table.
3. ARP Inspection.
4. Blacklist Filter. (arp-inspection mac-filter table)

7.4.1.1 DHCP Snooping

DHCP snooping is a DHCP security feature that provides network security by filtering un-trusted DHCP messages and by building and maintaining a DHCP snooping binding database, which is also referred to as a DHCP snooping binding table.

DHCP snooping acts like a firewall between un-trusted hosts and DHCP servers. You can use DHCP snooping to differentiate between un-trusted interfaces connected to the end user and trusted interfaces connected to the DHCP server or another switch.

The DHCP snooping binding database contains the MAC address, the IP address, the lease time, the binding type, the VLAN number, and the interface information that corresponds to the local un-trusted interfaces of a switch.

When a switch receives a packet on an un-trusted interface and the interface belongs to a VLAN in which DHCP snooping is enabled, the switch compares the source MAC address and the DHCP client hardware address. If addresses match (the default), the switch forwards the packet. If the addresses do not match, the switch drops the packet.

The switch drops a DHCP packet when one of these situations occurs:

- ✓ A packet from a DHCP server, such as a DHCPOFFER, DHCPACK, DHCPNAK, or DHCPLEASEQUERY packet, is received from the un-trusted port.
- ✓ A packet is received on an un-trusted interface, and the source MAC address and the

DHCP client hardware address do not match any of the current bindings.
Use DHCP snooping to filter unauthorized DHCP packets on the network and to build the binding table dynamically. This can prevent clients from getting IP addresses from unauthorized DHCP servers.

Trusted vs. Un-trusted Ports

Every port is either a trusted port or an un-trusted port for DHCP snooping. This setting is independent of the trusted/un-trusted setting for ARP inspection. You can also specify the maximum number for DHCP packets that each port (trusted or un-trusted) can receive each second.

Trusted ports are connected to DHCP servers or other switches. The Switch discards DHCP packets from trusted ports only if the rate at which DHCP packets arrive is too high. The Switch learns dynamic bindings from trusted ports.

Note: The Switch will drop all DHCP requests if you enable DHCP snooping and there are no trusted ports.

Un-trusted ports are connected to subscribers. The Switch discards DHCP packets from un-trusted ports in the following situations:

- The packet is a DHCP server packet (for example, OFFER, ACK, or NACK).
- The source MAC address and source IP address in the packet do not match any of the current bindings.
- The packet is a RELEASE or DECLINE packet, and the source MAC address and source port do not match any of the current bindings.
- The rate at which DHCP packets arrive is too high.

DHCP Snooping Database

The Switch stores the binding table in volatile memory. If the Switch restarts, it loads static bindings from permanent memory but loses the dynamic bindings, in which case the devices in the network have to send DHCP requests again.

Configuring DHCP Snooping

Follow these steps to configure DHCP snooping on the Switch.

1. Enable DHCP snooping on the Switch.
2. Enable DHCP snooping on each VLAN.
3. Configure trusted and un-trusted ports.
4. Configure static bindings.

Note:

The Switch will drop all DHCP requests if you enable DHCP snooping and there are no trusted ports.

If the port link down, the entries learned by this port in the DHCP snooping binding table will be deleted.

You must enable the global DHCP snooping and DHCP Snooping for vlan first.

The main purposes of the DHCP Snooping are:

1. Create and maintain binding table for ARP Inspection function.

- Filter the DHCP server's packets that the DHCP server connects to an un-trusted port.

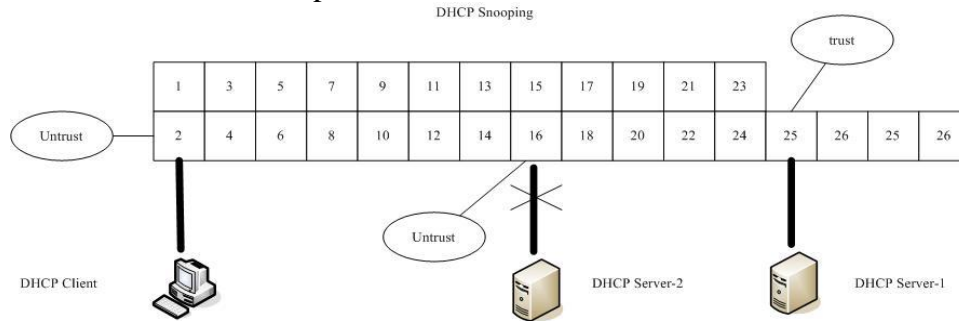

The DHCP server connected to an un-trusted port will be filtered.

Notices

There are a global state and per VLAN states.

When the global state is disabled, the DHCP Snooping on the Switch is disabled even per VLAN states are enabled.

When the global state is enabled, user must enable per VLAN states to enable the DHCP Snooping on the specific VLAN.

VLAN 1 : port 1-4.
 DHCP Client-1 : connect to port 3.
 DHCP Server : connect to port 1.

Procedures:

- Default environments:
 - DHCP Client-1: `ipconfig /release`
 - DHCP Client-1: `ipconfig /renew`
 → DHCP Client-1 can get an IP address.
- Enable the global DHCP Snooping.
 - L2SWITCH(config)#`dhcp-snooping`
 - DHCP Client-1: `ipconfig /release`
 - DHCP Client-1: `ipconfig /renew`
 → DHCP Client-1 can get an IP address.
- Enable the global DHCP Snooping and VLAN 1 DHCP Snooping.
 - L2SWITCH(config)#`dhcp-snooping`
 - L2SWITCH(config)#`dhcp-snooping vlan 1`
 - DHCP Client-1: `ipconfig /release`
 - DHCP Client-1: `ipconfig /renew`
 → DHCP Client-1 cannot get an IP address.
 ; Because the DHCP server connects to a un-trust port.
- Enable the global DHCP Snooping and VLAN 1 DHCP Snooping.
 - L2SWITCH(config)#`dhcp-snooping`
 - L2SWITCH(config)#`dhcp-snooping vlan 1`

- C. L2SWITCH(config)#interface gi1/0/1
- D. L2SWITCH(config-if)#dhcp-snooping trust
- E. DHCP Client-1: ipconfig /release
- F. DHCP Client-1: ipconfig /renew
 → DHCP Client-1 can get an IP address.

5. If you configure a static host entry in the DHCP snooping binding table, and then you want to change the host to DHCP client, the host will not get a new IP from DHCP server, and then you must delete the static host entry first.

7.4.1.1.1 DHCP Snooping 7.4.1.1.1.1 CLI Configurations

Node	Command	Description
enable	show dhcp-snooping	This command displays the current DHCP snooping configurations.
enable	configure terminal	This command changes the node to configure node.
configure	dhcp-snooping (disable enable)	This command disables/enables the DHCP snooping on the switch.
configure	dhcp-snooping vlan VLANLISTS	This command enables the DHCP snooping function on a VLAN or range of VLANs.
configure	no dhcp-snooping vlan VLANLISTS	This command disables the DHCP snooping function on a VLAN or range of VLANs.

Example:

```
L2SWITCH#configure terminal
L2SWITCH(config)#dhcp-snooping enable
L2SWITCH(config)#dhcp-snooping vlan 1
```

7.4.1.1.1.2 Web Configurations

DHCP Snooping

DHCP Snooping
Port Settings
Server Screening

DHCP Snooping Settings

State

VLAN State

DHCP Snooping Status

DHCP Snooping State	Disabled
Enabled on VLAN	None

Parameter	Description
-----------	-------------

DHCP Snooping Settings	
State	Select Enable to use DHCP snooping on the Switch. You still have to enable DHCP snooping on specific VLANs and specify trusted ports. Note: The Switch will drop all DHCP requests if you enable DHCP snooping and there are no trusted ports. Select Disable to not use DHCP snooping.
VLAN State	Select Add and enter the VLAN IDs you want the Switch to enable DHCP snooping on. You can designate multiple VLANs individually by using a comma (,) and by range with a hyphen (-). Select Delete and enter the VLAN IDs you no longer want the Switch to use DHCP snooping on.
Apply	Click Apply to take effect the settings.
Refresh	Click Refresh to begin configuring this screen afresh.
DHCP Snooping Status	
DHCP Snooping State	This field displays the current status of the DHCP snooping feature, Enabled or Disabled .
Enabled on VLAN	This field displays the VLAN IDs that have DHCP snooping enabled on them. This will display None if no VLANs have been set.

7.4.1.1.2 Port Settings

7.4.1.1.2.1 CLI Configurations

Node	Command	Description
enable	show dhcp-snooping	This command displays the current DHCP snooping configurations.
enable	configure terminal	This command changes the node to configure node.
configure	interface IFNAME	This command enters the interface configure node.
interface	dhcp-snooping host count <1-32>	This command configures the maximum host count for the specific port.
interface	no dhcp-snooping host count	This command configures the maximum host count to default for the specific port. The default host count is 32.
interface	dhcp-snooping trust	This command configures the trust port for the specific port.
interface	no dhcp-snooping trust	This command configures the un-trust port for the specific port.
configure	interface range gigabitethernet1/0/PORTLISTS	This command enters the if-range configure node.
if-range	dhcp-snooping host count <1-32>	This command configures the maximum host count for the specific ports.
if-range	no dhcp-snooping host count	This command configures the maximum host count to default for the specific ports. The default host count is 32.
if-range	dhcp-snooping trust	This command configures the trust port for the specific ports.
if-range	no dhcp-snooping trust	This command configures the un-trust port for the specific ports.

7.4.1.1.2.2 Web Configurations

DHCP Snooping

DHCP Snooping
Port Settings
Server Screening

Port Settings

Port: From: To:

Trust:

Maximum Host Count: (Range: 1-32)

Port Status

Port	Trusted	Maximum Host Count	Port	Trusted	Maximum Host Count
1	NO	32	2	NO	32
3	NO	32	4	NO	32
5	NO	32	6	NO	32
7	NO	32	8	NO	32
9	NO	32	10	NO	32
11	NO	32	12	NO	32

Parameter	Description
Port Settings	
Port	Select a port number to modify its configurations..
Trust	Configures the specific port if it is a trust port.
Maximum Host Count	Enter the maximum number of hosts (1-32) that are permitted to simultaneously connect to a port.
Apply	Click Apply to take effect the settings.
Refresh	Click Refresh to begin configuring this screen afresh.

7.4.1.1.3 Server Screening

The Switch supports DHCP Server Screening, a feature that denies access to rogue DHCP servers. That is, when one or more DHCP servers are present on the network and both provide DHCP services to different distinct groups of clients, the valid DHCP server's packets will be passed to the client.

If you want to enable this feature, you must enable the DHCP Snooping function first. The Switch allows users to configure up to three valid DHCP servers.

If no DHCP servers are configured, it means all DHCP server are valid.

7.4.1.1.3.1 CLI Configurations

Node	Command	Description
enable	show dhcp-snooping server	This command displays the valid DHCP server IP.
enable	configure terminal	This command changes the node to configure node.
configure	dhcp-snooping server IPADDR	This command configures a valid DHCP server's IP.
configure	no dhcp-snooping server IPADDR	This command removes a valid DHCP server's IP.

7.4.1.1.3.2 Web Configurations

DHCP Snooping

DHCP Snooping
Port Settings
Server Screening

Server Screening Setting

DHCP Server IP

Server Screening List

No.	IP Address	Action

Parameter	Description
Server Screening Settings	
DHCP Server IP	This field configures the valid DHCP server's IP address.
Apply	Click Apply to configure the settings.
Refresh	Click Refresh to begin configuring this screen afresh.
Server Screening List	

No.	This field displays the index number of the DHCP server entry. Click the number to modify the entry.
IP Address	This field displays the IP address of the DHCP server.
Action	Click Delete to remove a configured DHCP server.

7.4.2 Binding Table

The DHCP Snooping binding table records the host information learned by DHCP snooping function (dynamic) or set by user (static). The ARP inspection will use this table to forward or drop the ARP packets. If the ARP packets sent by invalid host, they will be dropped. If the Lease time is expired, the entry will be removed from the table.

Static bindings are uniquely identified by the MAC address and VLAN ID. Each MAC address and VLAN ID can only be in one static binding. If you try to create a static binding with the same MAC address and VLAN ID as an existing static binding, the new static binding replaces the original one.

7.4.2.1 Static Entry

7.4.2.1.1 CLI Configurations

Node	Command	Description
enable	show dhcp-snooping binding	This command displays the current DHCP snooping binding table.
enable	configure terminal	This command changes the node to configure node.
configure	dhcp-snooping binding mac MAC_ADDR ip IP_ADDR vlan <1-4094> port PORT_NO	This command configures a static host into the DHCP snooping binding table.
configure	no dhcp-snooping binding mac MACADDR	This command removes a static host from the DHCP snooping binding table.

Example:

```
L2SWITCH#configure terminal
L2SWITCH(config)#dhcp-snooping binding mac 00:11:22:33:44:55 ip 1.1.1.1 vlan 1 port2
L2SWITCH(config)#no dhcp-snooping binding mac 00:11:22:33:44:55
L2SWITCH#show dhcp-snooping binding
```

7.4.2.1.2 Web Configurations

DHCP Snooping Binding Table

Static Entry
Binding Table

Static Entry Settings

MAC Address

IP Address

VLAN ID

Port

1
▼

Static Binding Table

No.	MAC Address	IP Address	Lease(hour)	VLAN	Port	Type	Action
-----	-------------	------------	-------------	------	------	------	--------

Parameter	Description
Static Entry Settings	
MAC Address	Enter the source MAC address in the binding.
IP Address	Enter the IP address assigned to the MAC address in the binding.
VLAN ID	Enter the source VLAN ID in the binding.
Port	Specify the port in the binding.
Apply	Click Apply to configure the settings.
Refresh	Click Refresh to begin configuring this screen afresh.
Static Binding Table	
No.	This field displays a sequential number for each binding. Click it to update an existing entry.
MAC Address	This field displays the source MAC address in the binding.
IP Address	This field displays the IP address assigned to the MAC address in the binding.
Lease (Hour)	This field displays how long the binding is valid.
VLAN	This field displays the source VLAN ID in the binding.
Port	This field displays the port number in the binding.
Type	This field displays how the Switch learned the binding. Static: This binding was learned from information provided

	manually by an administrator. Dynamic: This binding was learned by snooping DHCP packets.
Action	Click Delete to remove the specified entry.

7.4.2.2 Binding Table

Bindings are used by DHCP snooping and ARP inspection to distinguish between authorized and unauthorized packets in the network. The Switch learns the dynamic bindings by snooping DHCP packets and from information provided manually in the **Static Entry Settings** screen.

7.4.2.2.1 CLI Configurations

Node	Command	Description
enable	show dhcp-snooping binding	This command displays the current DHCP snooping binding table.

7.4.2.2.2 Web Configurations

DHCP Snooping Binding Table

Static Entry
Binding Table

DHCP Snooping Binding Table

Show Type All ▼ Show

*You can select the dynamic entry and convert it to static status.

<input type="checkbox"/> *All	MAC Address	IP Address	Lease(hour)	VLAN	Port	Type
-------------------------------	-------------	------------	-------------	------	------	------

Apply
Refresh

Parameter	Description
DHCP Snooping Binding Table	
MAC Address	This field displays the source MAC address in the binding.
IP Address	This field displays the IP address assigned to the MAC address in the binding.
Lease	This field displays how long the binding is valid.
VLAN	This field displays the source VLAN ID in the binding.
Port	This field displays the port number in the binding. If this field is blank, the binding applies to all ports.
Type	This field displays how the Switch learned the binding. Static: This binding was learned from information provided manually by an administrator.

	Dynamic: This binding was learned by snooping DHCP packets.
Apply	Click Apply to configure the settings.
Refresh	Click Refresh to begin configuring this screen afresh.

7.4.3 ARP Inspection

Dynamic ARP inspection is a security feature which validates ARP packet in a network by performing IP to MAC address binding inspection. Those will be stored in a trusted database (the DHCP snooping database) before forwarding. Dynamic ARP intercepts, logs, and discards ARP packets with invalid IP-to-MAC address bindings. This capability protects the network from certain man-in-the-middle attacks.

Dynamic ARP inspection ensures that only valid ARP requests and responses are relayed. The switch performs these activities:

- Intercepts all ARP requests and responses on untrusted ports.
- Verifies that each of these intercepted packets has a valid IP-to-MAC address binding before it updates the local ARP cache or before it forwards the packet to the appropriate destination.

Trusted and untrusted port

- This setting is independent of the trusted and untrusted setting of the DHCP Snooping.
- The Switch does not discard ARP packets on trusted ports for any reasons.
- The Switch discards ARP packets on un-trusted ports if the sender's information in the ARP packets does not match any of the current bindings.
- Normally, the trusted ports are the uplink port and the untrusted ports are connected to subscribers.

Configurations:

Users can enable/disable the ARP Inspection on the Switch. Users also can enable/disable the ARP Inspection on a specific VLAN. If the ARP Inspection on the Switch is disabled, the ARP Inspection is disabled on all VLANs even some of the VLAN ARP Inspection are enabled.

Notices

There are a global state and per VLAN states.

- ✓ When the global state is disabled, the ARP Inspection on the Switch is disabled even per VLAN states are enabled.
- ✓ When the global state is enabled, user must enable per VLAN states to enable the ARP Inspection on the specific VLAN.

7.4.3.1 ARP Inspection

7.4.3.1.1 CLI Configurations

Node	Command	Description
enable	show arp-inspection	This command displays the current ARP Inspection configurations.
enable	configure terminal	This command changes the node to configure node.
configure	arp-inspection (disable enable)	This command disables/enables the ARP Inspection function on the switch.
configure	arp-inspection vlan VLANLISTS	This command enables the ARP Inspection function on a VLAN or range of VLANs.

configure	no arp-inspection vlan VLANLISTS	This command disables the ARP Inspection function on a VLAN or range of VLANs.
configure	interface IFNAME	This command enters the interface configure node.
interface	arp-inspection trust	This command configures the trust port for the specific port.
interface	no arp-inspection trust	This command configures the un-trust port for the specific port.

Example:

```
L2SWITCH#configure terminal
L2SWITCH(config)#arp-inspection enable
L2SWITCH(config)#arp-inspection vlan 1
L2SWITCH(config)#interface 1/0/1
L2SWITCH(config-if)#arp-inspection trust
```

7.4.3.1.2 Web Configurations

ARP Inspection

ARP Inspection
Filter Table

ARP Inspection Settings

State: Disable ▾

VLAN State: Add ▾

Trusted Ports

Select All Deselect All

2 4 6 8 10 12

1 3 5 7 9 11

Apply Refresh

ARP Inspection Status

ARP Inspection State	Disabled
Enabled on VLAN	None
Trusted Ports	None

Parameter	Description
ARP Inspection Settings	
State	Use this to Enable or Disable ARP inspection on the Switch.
VLAN State	Enter the VLAN IDs you want the Switch to enable ARP Inspection for. You can designate multiple VLANs individually by using a comma (,) and by range with a hyphen (-).

Trusted Ports	<p>Select the ports which are trusted and deselect the ports which are un-trusted.</p> <p>The Switch does not discard ARP packets on trusted ports for any reason.</p> <p>The Switch discards ARP packets on un-trusted ports in the following situations:</p> <ul style="list-style-type: none"> • The sender's information in the ARP packet does not match any of the current bindings. • The rate at which ARP packets arrive is too high. You can specify the maximum rate at which ARP packets can arrive on un-trusted ports.
Select All	Click this to set all ports to trusted.
Deselect All	Click this to set all ports to un-trusted.
Apply	Click Apply to take effect the settings.
Refresh	Click Refresh to begin configuring this screen afresh.
ARP Inspection Status	
ARP Inspection State	This field displays the current status of the ARP Inspection feature, Enabled or Disabled .
Enabled on VLAN	This field displays the VLAN IDs that have ARP Inspection enabled on them. This will display None if no VLANs have been set.
Trusted Ports	This field displays the ports which are trusted. This will display None if no ports are trusted.

7.4.3.2 Filter Table

Dynamic ARP inspections validates the packet by performing IP to MAC address binding inspection stored in a trusted database (the DHCP snooping database) before forwarding the packet. When the Switch identifies an unauthorized ARP packet, it automatically creates a MAC address filter to block traffic from the source MAC address and source VLAN ID of the unauthorized ARP packet. The switch also periodically deletes entries if the age-time for the entry is expired.

- If the ARP Inspection is enabled and the system detects invalid hosts, the system will create a filtered entry in the MAC address table.
- When Port link down and ARP Inspection was disabled, Switch will remove the MAC-filter entries learned by this port.
- When Port link down and ARP Inspection was enabled, Switch will remove the MAC-filter entries learned by this port.
- The maximum entry of the MAC address filter table is 256.
- When MAC address filter table of ARP Inspection is full, the Switch receives unauthorized ARP packet, and it automatically creates a SYSLOG and drop this ARP packet. The SYSLOG event happens on the first time.

7.4.3.2.1 CLI Configurations

Node	Command	Description
enable	show arp-inspection mac-filter	This command displays the current ARP Inspection filtered MAC.
enable	configure terminal	This command changes the node to configure node.
configure	arp-inspection mac-filter age <1-10080>	This command configures the age time for the ARP inspection MAC filter entry.
configure	clear arp-inspection mac-filter	This command clears all of entries in the filter table.
configure	no arp-inspection mac-filter mac MACADDR vlan <1-4094>	This command removes an entry from the ARP inspection MAC filter table.

7.4.3.2.2 Web Configurations

ARP Inspection

ARP Inspection
Filter Table

Filter Age Time Settings

Filter Age Time Minutes (Range: 1-10080)

Filter Table

No.	MAC Address	VLAN	Port	Expiry(min)	Action
Total Counts:0					

Parameter	Description
Filter Age Time Settings	
Filter Age Time	This setting has no effect on existing MAC address filters. Enter how long (1-10080 minutes) the MAC address filter remains in the Switch after the Switch identifies an unauthorized ARP packet. The Switch automatically deletes the MAC address filter afterwards.
Apply	Click Apply to take effect the settings.
Refresh	Click Refresh to begin configuring this screen afresh.
Filter Table	
No.	This field displays a sequential number for each MAC addressfilter.
MAC Address	This field displays the source MAC address in the MAC addressfilter.
VLAN	This field displays the source VLAN ID in the MAC address filter.
Port	This field displays the source port of the discarded ARP packet.
Expiry (min)	This field displays how long (in minutes) the MAC address filter remains in the Switch.
Action	Click Delete to remove the record manually.
Total	This field displays the current number of MAC address filters that were created because the Switch identified unauthorized ARP packets.

7.5 ACL

Access control list (ACL) is a list of permissions attached to an object. The list specifies who or what is allowed to access the object and what operations are allowed to be performed on the object.

L2 ACL function allows user to configure a few rules to reject packets from the specific ingress ports or all ports. These rules will check the packets' source MAC address and destination MAC address. If packets match these rules, the system will do the actions "deny". "deny" means rejecting these packets.

The Action Resolution engine collects the information (action and metering results) from the hit entries: if more than one rule matches, the actions and meter/counters are taken from the policy associated with the matched rule with highest priority.

L2 ACL Support:

1. Filter a specific source MAC address.
Command: *sourcema host MACADDR*
2. Filter a specific destination MAC address.
Command: *destination mac host MACADDR*
3. Filter a range of source MAC address.
Command: *sourcema MACADDR MACADDR*
The second MACADDR is a mask, for example: ffff.ffff.0000
4. Filter a range of destination MAC address.
Command: *destination mac MACADDR MACADDR*
The second MACADDR is a mask, for example: ffff.ffff.0000

L3 ACL Support:

1. Filter a specific source IP address.
Command: *source ip host IPADDR*
2. Filter a specific destination IP address.
Command: *destination iphost IPADDR*
3. Filter a range of source IP address.
Command: *source ip IPADDRIPADDR*
The second IPADDR is a mask, for example: 255.255.0.0
4. Filter a range of destination IP address.
Command: *destinationip IPADDRIPADDR*

L4 ACL Support:

1. Filter a UDP/TCP source port.
2. Filter a UDP/TCP destination port.

Notices:

- Maximum profile : 64.
- Maximum profile name length : 16.
- The ACL name should be the combination of the digit or the alphabet.

7.5.1 CLI Configurations

Node	Command	Description
enable	show access-list	This command displays all of the access control profiles.
enable	configure terminal	This command changes the node to configure node.
configure	access-list STRING ip-type (ipv4 ipv6)	This command creates a new access control profile. Where the STRING is the profile name. And you can specify the type, ipv4 or ipv6.
configure	no access-list STRING	This command deletes an access control profile.
acl	show	This command displays the current access control profile.
acl	action (disable drop permit dscp 802.1p)	This command activates this profile. disable – disable the profile. drop – If packets match the profile, the packets will be dropped. permit – If packets match the profile, the packets will be forwarded. dscp – dscp remark. 802.1p – 802.1p remark.
acl	action dscp remarking <0-63>	This command activates this profile and specifies that it is for DSCP remark. And configures the new DSCP value which will be overridden to all packets matched this profile.
acl	action 802.1p remarking <0-7>	This command activates this profile and specifies that it is for 802.1p remark. And configures the new 802.1p value which will be overridden to all packets matched this profile.
acl	802.1p VALUE	This command configures the 802.1p value for the profile.
acl	dscp VALUE	This command configures the DSCP value for the profile.
acl	destination mac hostMACADDR	This command configures the destination MAC and mask for the profile.
acl	destination mac MACADDR MACADDR	This command configures the destination MAC and mask for the profile.
acl	destination mac MACADDR MACADDR	This command configures the destination MAC and mask for the profile. The second MACADDR parameter is the mask for the profile.
acl	no destination mac	This command removes the destination MAC from the profile.

acl	ethertype STRING	This command configures the ether type for the profile. Where the STRING is a hex-decimal value. e.g.: 08AA.
acl	no ethertype	This command removes the limitation of the ether type from the profile.
acl	source mac host MACADDR	This command configures the source MAC and mask for the profile.
acl	source mac MACADDR MACADDR	This command configures the source AMC and mask for the profile.
acl	no source mac	This command removes the source MAC and mask from the profile.
acl	source ip host IPADDR	This command configures the source IP address for the profile.
acl	source ip IPADDR IPMASK	This command configures the source IP address and mask for the profile.
acl	no source ip	This command removes the source IP address from the profile.
acl	destination ip host IPADDR	This command configures a specific destination IP address for the profile.
acl	destination ip IPADDR IPMASK	This command configures the destination IP address and mask for the profile.
acl	no destination ip	This command removes the destination IP address from the profile.
acl	l4-source-port IPADDR	This command configures UDP/TCP source port for the profile.
acl	no l4-source-port IPADDR	This command removes the UDP/TCP source port from the profile.
acl	L4-destination-port PORT	This command configures the UDP/TCP destination port for the profile.
acl	no l4-destination-port	This command removes the UDP/TCP destination port from the profile.
acl	vlan <1-4094>	This command configures the VLAN for the profile.
acl	no vlan	This command removes the limitation of the VLAN from the profile.
acl	source interface PORT_ID	This command configures the source interface for the profile.
acl	no source interface PORT_ID	This command removes the source interface from the profile.

Where the MAC mask allows users to filter a range of MAC in the packets' source MAC or destination MAC.

For example:

```
source mac 00:01:02:03:04:05 ff:ff:ff:ff:00
```

- ➔ The command will filter source MAC range from 00:01:02:03:00:00 to 00:01:02:03:ff:ff

Where the IPMASK mask allows users to filter a range of IP in the packets' source IP or destination IP.

For example:

```
source ip 172.20.1.1 255.255.0.0
```

- ➔ The command will filter source IP range from 172.20.0.0 to 172.20.255.255

Example:

```
L2SWITCH#configure terminal
L2SWITCH(config)#access-list 111
L2SWITCH(config-acl)#vlan 2
L2SWITCH(config-acl)#source interface 1
L2SWITCH(config-acl)#show
Profile Name: 111
Activate: disabled
VLAN: 2
Source Interface: 1
Destination MAC Address: any
Source MAC Address: any
Ethernet Type: any
Source IP Address: any
Destination IP Address: any
Source Application: any
Destination Application: any
```

Note: Any: Don't care.

7.5.2 Web Configurations

Access Control List

Access Control List Settings

IP Type	IPv4 ▾	Profile Name	<input type="text"/>	Action	Disable ▾
Ethernet Type	Any ▾ <input type="text"/>	VLAN	Any ▾ <input type="text"/>		
Source MAC	Any ▾ <input type="text"/>	Mask of Source MAC	<input type="text"/>		
Destination MAC	Any ▾ <input type="text"/>	Mask of Destination MAC	<input type="text"/>		
DSCP	Any ▾ 0 ▾	802.1p	Any ▾ 0 ▾		
Source IP	Any ▾ <input type="text"/>	Mask of Source IP	<input type="text"/>		
Destination IP	Any ▾ <input type="text"/>	Mask of Destination IP	<input type="text"/>		
IP Protocol	Any ▾ <input type="text"/>				
Source Application	Any ▾ <input type="text"/>				
Destination Application	Any ▾ <input type="text"/>				
Source Interface	Any ▾ -- ▾				

Access Control List Status

Parameter	Description
Access Control List Settings	
IP Type	Selects IPv4 / IPv6 type for the profile.
Profile Name	The access control profile name.
Action	Selects Disables/Drop/Permits/DSCP/802.1P action for the profile.
Ethernet Type	Configures the Ethernet type of the packets for the profile.
VLAN	Configures the VLAN of the packets for the profile.
Source MAC	Configures the source MAC of the packets for the profile.
Mask of Source MAC	Configures the bitmap mask of the source MAC of the packets for the profile. If the Source MAC field has been configured and this field is empty, it means the profile will filter the one MAC configured in Source MAC field.
Destination MAC	Configures the destination MAC of the packets that you want to filter.

Mask of Destination MAC	Configures the bitmap mask of the destination MAC of the packets that you want to filter. If the Destination MAC field has been configured and this field is empty, it means the profile will filter the one MAC configured in Destination MAC field.
DSCP	Configure the DSCP for the profile.
802.1p	Configures the 802.1p for the profile.
Source IP	Configures the source IP of the packets for the profile.
Mask of Source IP	Configures the bitmap mask of the source IP of the packets for the profile. If the Source IP field has been configured and this field is empty, it means the profile will filter the one IP configured in Source IP field.
Destination IP	Configures the destination IP of the packets for the profile.
Mask of Destination IP	Configures the bitmap mask of the destination IP of the packets for the profile. If the Destination IP field has been configured and this field is empty, it means the profile will filter the one IP configured in Destination IP field.
IP Protocol	Configures the IP protocol type. The setting will be used for Source Application and Destination Application. TCP:0x06. UDP:0x11.
Source Application	Configures the source UDP/TCP ports of the packets for the profile.
Destination Application	Configures the destination UDP/TCP ports of the packets for the profile.
Source Interface(s)	Configures one or a range of the source interfaces of the packets for the profile.
Apply	Click Apply to take effect the settings.
Refresh	Click Refresh to begin configuring this screen afresh.

7.6 802.1X

IEEE 802.1X is an IEEE Standard for port-based Network Access Control ("port" meaning a single point of attachment to the LAN infrastructure). It is part of the IEEE 802.1 group of networking protocols. It provides an authentication mechanism to devices wishing to attach to a LAN, either establishing a point-to-point connection or preventing it if authentication fails. It is used for most wireless 802.11 access points and is based on the Extensible Authentication Protocol (EAP).

802.1X provides port-based authentication, which involves communications between a supplicant, authenticator, and authentication server. The supplicant is often software on a client device, such as a laptop, the authenticator is a wired Ethernet switch or wireless access point, and an authentication server is generally a RADIUS database. The authenticator acts like a security guard to a protected network. The supplicant (i.e., client device) is not allowed access through the authenticator to the protected side of the network until the supplicant's identity is authorized. An analogy to this is providing a valid passport at an airport before being allowed to pass through security to the terminal. With 802.1X port-based authentication, the supplicant provides credentials, such as user name/password or digital certificate, to the authenticator, and the authenticator forwards the credentials to the authentication server for verification. If the credentials are valid (in the authentication server database), the supplicant (client device) is allowed to access resources located on the protected side of the network.

Upon detection of the new client (supplicant), the port on the switch (authenticator) is enabled and set to the "**unauthorized**" state. In this state, only 802.1X traffic is allowed; other traffic, such as DHCP and HTTP, is blocked at the network layer (Layer 3). The authenticator sends out the EAP-Request identity to the supplicant, the supplicant responds with the EAP-response packet that the authenticator forwards to the authenticating server. If the authenticating server accepts the request, the authenticator sets the port to the "authorized" mode and normal traffic is allowed. When the supplicant logs off, it sends an EAP-logoff message to the authenticator. The authenticator then sets the port to the "unauthorized" state, once again blocking all non-EAP traffic.

The following figure illustrates how a client connecting to an IEEE 802.1x authentication enabled port goes through a validation process. The Switch prompts the client for login information in the form of a user name and password.

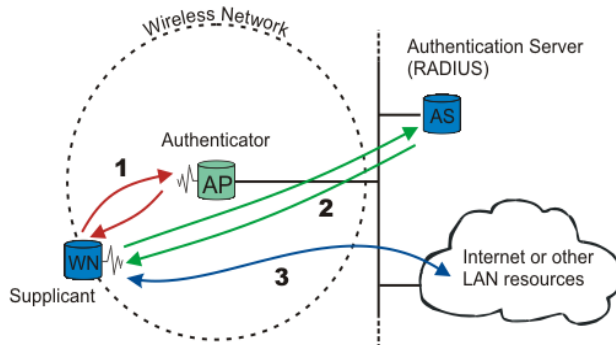

When the client provides the login credentials, the Switch sends an authentication request to a RADIUS server. The RADIUS server validates whether this client is allowed access to the port.

Local User Accounts

By storing user profiles locally on the Switch, your Switch is able to authenticate users without interacting with a network authentication server. However, there is a limit on the number of users you may authenticate in this way.

Guest VLAN:

The Guest VLAN in IEEE 802.1x port authentication on the switch to provide limited services to clients, such as downloading the IEEE 802.1x client. These clients might be upgrading their system for IEEE 802.1x authentication.

When you enable a guest VLAN on an IEEE 802.1x port, the switch assigns clients to a guest VLAN when the switch does not receive a response to its EAP request/identity frame or when EAPOL packets are not sent by the client.

Port Parameters:

● Admin Control Direction:

- both - drop incoming and outgoing packets on the port when a user has not passed 802.1x port authentication.
- in - drop only incoming packets on the port when a user has not passed 802.1x port authentication.

● Re-authentication:

Specify if a subscriber has to periodically re-enter his or her user name and password to stay connected to the port.

● Reauth-period:

Specify how often a client has to re-enter his or her username and password to stay connected to the port. The acceptable range for this field is 0 to 65535 seconds.

● Port Control Mode:

- auto : Users can access network after authenticating.
- force-authorized : Users can access network without authentication.
- force-unauthorized : Users cannot access network.

● Quiet Period:

Specify a period of the time the client has to wait before the next re-authentication attempt. This will prevent the Switch from becoming overloaded with continuous re-authentication attempts from the client. The acceptable range for this field is 0 to 65535 seconds.

● Server Timeout:

The server-timeout value is used for timing out the Authentication Server.

● Supp-Timeout:

The supp-timeout value is the initialization value used for timing out a Supplicant.

- **Max-req Time:**
Specify the amount of times the Switch will try to connect to the authentication server before determining the server is down. The acceptable range for this field is 1 to 10 times.

Default Settings

The default global 802.1x state is disabled.
 The default 802.1x Authentication Method is local.
 The default port 802.1x state is disabled for all ports.
 The default port Admin Control Direction is both for all ports.
 The default port Re-authentication is disabled for all ports.
 The default port Control Mode is auto for all ports.
 The default port Guest VLAN is 0 for all ports. (Guest VLAN is disabled).
 The default port Max-req Time is 2 times for all ports.
 The default port Reauth period is 3600 seconds for all ports.
 The default port Quiet period is 60 seconds for all ports.
 The default port Supp timeout is 30 seconds for all ports.
 The default port Server timeout is 30 seconds for all ports.

7.6.1 Global Settings

7.6.1.1 CLI Configurations

Node	Command	Description
enable	show dot1x	This command displays the current 802.1x configurations.
enable	show dot1x username	This command displays the current user accounts for the local authentication.
enable	show dot1x accounting-record	This command displays the local accounting records.
enable	configure terminal	This command changes the node to configure node.
configure	dot1x authentication (disable enable)	This command enables/disables the 802.1x authentication on the switch.
configure	dot1x authentic-method (local radius)	This command configures the authentic method of 802.1x.
configure	no dot1x authentic-method	This command configures the authentic method of 802.1x to default.
configure	dot1x accounting (disable enable)	This command enables/disables the dot1x local accounting records.
configure	dot1x accounting-clean	This command cleans all of the accounting records.
configure	dot1x default	This command sets all of the configuration to default settings.
configure	dot1x guest-vlan <1-4094>	This command configures the guest vlan.
configure	no dot1x guest-vlan	This command removes the guest vlan.
configure	dot1x radius primary-server-ip <IP> port PORTID	This command configures the primary radius server.
configure	dot1x radius primary-server-ip <IP> port PORTID key KEY	This command configures the primary radius server.

configure	no dot1x radius primary-server-ip	This command removes the secondary radius server.
configure	dot1x radius secondary-server-ip <IP> port PORTID	This command configures the secondary radius server.
configure	dot1x radius secondary-server-ip <IP> port PORTID key KEY	This command configures the secondary radius server.
configure	no dot1x radius secondary-server-ip	This command removes the secondary radius server.
configure	dot1x username <USERNAME> <PASSWORD>	This command configures the user account for local authentication.
configure	no dot1x username <STRING>	This command deletes the user account for local authentication.

7.6.1.2 Web Configurations

802.1X

Global Settings
Port Settings

Global Settings

State	<input type="text" value="Disable"/>		
Authentication Method	<input type="text" value="Local"/>		
Guest VLAN	<input type="text" value="0"/>		
Primary Radius Server	IP : <input type="text"/>	UDP Port : <input type="text"/>	Shared Key : <input type="text"/>
Secondary Radius Server	IP : <input type="text"/>	UDP Port : <input type="text"/>	Shared Key : <input type="text"/>

Global Status

State	Disabled		
Authentication Method	Local		
Guest VLAN	0		
Primary Radius Server	IP : -	UDP Port : -	Shared Key : -
Secondary Radius Server	IP : -	UDP Port : -	Shared Key : -

Parameter	Description
Global Settings	
State	Select Enable to permit 802.1x authentication on the Switch. Note: You must first enable 802.1x authentication on the Switch before configuring it on each port.
Authentication Method	Select whether to use Local or RADIUS as the authentication method. The Local method of authentication uses the “guest” and “user” user groups of the user account database on the Switch itself to authenticate.

	<p>However, only a certain number of accounts can exist at one time. RADIUS is a security protocol used to authenticate users by means of an external server instead of an internal device user database that is limited to the memory capacity of the device. In essence, RADIUS allows you to validate an unlimited number of users from a central location.</p>
Guest VLAN	Configure the guest vlan.
Primary Radius Server	When RADIUS is selected as the 802.1x authentication method, the Primary Radius Server will be used for all authentication attempts.
IP Address	Enter the IP address of an external RADIUS server in dotted decimal notation.
UDP Port	The default port of a RADIUS server for authentication is 1812 .
Share Key	Specify a password (up to 32 alphanumeric characters) as the key to be shared between the external RADIUS server and the Switch. This key is not sent over the network. This key must be the same on the external RADIUS server and the Switch.
Second Radius Server	This is the backup server used only when the Primary Radius Server is down.
Apply	Click Apply to take effect the settings.
Refresh	Click Refresh to begin configuring this screen afresh.

7.6.2 Port Settings

7.6.2.1 CLI Configurations

Node	Command	Description
enable	show dot1x	This command displays the current 802.1x configurations.
enable	configure terminal	This command changes the node to configure node.
configure	interface IFNAME	This command enters the interface configure node.
interface	dot1x admin-control-direction (both in)	This command configures the control direction for blocking packets.
interface	dot1x default	This command sets the port configuration to default settings.
interface	dot1x max-req <1-10>	This command sets the max-req times for the port.
interface	dot1x port-control (auto force-authorized force-unauthorized)	This command configures the port control mode on the port.
interface	dot1x authentication (disable enable)	This command enables/disables the 802.1x authentication on the port.
interface	dot1x reauthentication (disable enable)	This command enables/disables re-authentication on the port.
interface	dot1x timeout quiet-period	This command configures the quiet-period value on the port.
interface	dot1x timeout server-timeout	This command configures the server-timeout value on the port.
interface	dot1x timeout reauth-period	This command configures the reauth-period value on the port.
interface	dot1x timeout supp-timeout	This command configures the supp-timeout value on the port.
interface	dot1x guest-vlan (disable enable)	This command disables / enables guest VLAN on the port.

7.6.2.2 Web Configurations

802.1X

Global Settings
Port Settings

Port Settings

Port: From: 1 To: 1

802.1X State: Disable

Admin Control Direction	Reauthentication	Port Control Mode	Guest VLAN	Max-req Times
Both	Disable	Auto	Disable	2
Reauth-period (sec)	Quiet-period (sec)	Supp-timeout (sec)	Server-timeout (sec)	Reset to Default
3600	20	30	16	<input type="checkbox"/>

Note : Please don't set ENABLE on all ports at the same time.

Port Status

Port	802.1X State	Admin Control Direction	Reauthentication	Port Control Mode	Guest VLAN	Max-req Times	Reauth-period	Quiet-period	Supp-timeout	Server-timeout
1	Disable	Both	Disable	Auto	Disable	2	3600	20	30	16
2	Disable	Both	Disable	Auto	Disable	2	3600	20	30	16
3	Disable	Both	Disable	Auto	Disable	2	3600	20	30	16
4	Disable	Both	Disable	Auto	Disable	2	3600	20	30	16
5	Disable	Both	Disable	Auto	Disable	2	3600	20	30	16
6	Disable	Both	Disable	Auto	Disable	2	3600	20	30	16
7	Disable	Both	Disable	Auto	Disable	2	3600	20	30	16
8	Disable	Both	Disable	Auto	Disable	2	3600	20	30	16
9	Disable	Both	Disable	Auto	Disable	2	3600	20	30	16
10	Disable	Both	Disable	Auto	Disable	2	3600	20	30	16
11	Disable	Both	Disable	Auto	Disable	2	3600	20	30	16
12	Disable	Both	Disable	Auto	Disable	2	3600	20	30	16

Parameter	Description
Port Settings	
Port	Select a port number to configure.
802.1x State	Select Enable to permit 802.1x authentication on the port. You must first enable 802.1x authentication on the Switch before configuring it on each port.
Admin Control Direction	Select Both to drop incoming and outgoing packets on the port when a user has not passed 802.1x port authentication. Select In to drop only incoming packets on the port when a user has not passed 802.1x port authentication.

Re-authentication	Specify if a subscriber has to periodically re-enter his or her user name and password to stay connected to the port.
Port Control Mode	Select Auto to require authentication on the port. Select Force Authorized to always force this port to be authorized. Select Force Unauthorized to always force this port to be unauthorized. No packets can pass through this port.
Guest VLAN	Select Disable to disable Guest VLAN on the port. Select Enable to enable Guest VLAN on the port.
Max-req Time	Specify the amount of times the Switch will try to connect to the authentication server before determining the server is down. The acceptable range for this field is 1 to 10 times.
Reauth period	Specify how often a client has to re-enter his or her username and password to stay connected to the port. The acceptable range for this field is 0 to 65535 seconds.
Quiet period	Specify a period of the time the client has to wait before the next re-authentication attempt. This will prevent the Switch from becoming overloaded with continuous re-authentication attempts from the client. The acceptable range for this field is 0 to 65535 seconds.
Supp timeout	Specify how long the Switch will wait before communicating with the server. The acceptable range for this field is 0 to 65535 seconds.
Server timeout	Specify how long the Switch to time out the Authentication Server. The acceptable range for this field is 0 to 65535 seconds.
Reset to Default	Select this and click Apply to reset the custom 802.1x port authentication settings back to default.
Apply	Click Apply to take effect the settings.
Refresh	Click Refresh to begin configuring this screen afresh.

7.7 Port Security

The Switch will learn the MAC address of the device directly connected to a particular port and allow traffic through. We will ask the question: “How do we control who and how many can connect to a switch port?” This is where port security can assist us. The Switch allow us to control which devices can connect to a switch port or how many of them can connect to it (such as when a hub or another switch is connected to the port).

Let’s say we have only one switch port left free and we need to connect five hosts to it. What can we do? Connect a hub or switch to the free port! Connecting a switch or a hub to a port has implications. It means that the network will have more traffic. If a switch or a hub is connected by a user instead of an administrator, then there are chances that loops will be created. So, it is best that number of hosts allowed to connect is restricted at the switch level. This can be done using the “port-security limit” command. This command configures the maximum number of MAC addresses that can source traffic through a port.

Port security can sets maximum number of MAC addresses allowed per interface. When the limit is exceeded, incoming packets with new MAC addresses are dropped. It can be use MAC table to check it. The static MAC addresses are included for the limit.

Note: If you configure a port of the Switch from disabled to enabled, all of the MAC learned by this port will be clear.

7.7.1 Port Security

7.7.1.1 CLI Configurations

Node	Command	Description
enable	show port-security	This command displays the current port security configurations.
enable	configure terminal	This command changes the node to configure node.
configure	port-security (disable enable)	This command enables / disables the global port security function.
configure	interface IFNAME	This command enters the interface configure node.
interface	port-security (disable enable)	This command enables / disables the port security function on the specific port.
interface	port-security limit <1-1000>	This command configures the maximum MAC entries on the specific port.
configure	interface range gigabitethernet1/0/ PORTLISTS	This command enters the if-range configure node.
if-range	port-security (disable enable)	This command enables / disables the port security function for the specified ports
if-range	port-security limit <1-1000>	This command configures the maximum MAC entries for the specified ports.

7.7.1.2 Web Configurations

Port Security

Port Security
Sticky MAC Settings

Port Security Settings

Port Security Disable ▾

Port	State	Sticky State	Maximum MAC
From: 1 ▾ To: 1 ▾	Disable ▾	Disable ▾	<input style="width: 50px;" type="text" value="5"/> (1~1000)

Apply
Refresh

Port Security Status

Port	State	Sticky State	Maximum MAC	Port	State	Sticky State	Maximum MAC
1	Disable	Disable	5	2	Disable	Disable	5
3	Disable	Disable	5	4	Disable	Disable	5
5	Disable	Disable	5	6	Disable	Disable	5
7	Disable	Disable	5	8	Disable	Disable	5
9	Disable	Disable	5	10	Disable	Disable	5
11	Disable	Disable	5	12	Disable	Disable	5

Parameter	Description
Port Security Settings	
Port Security	Select Enable/Disable to permit Port Security on the Switch.
Port	Select a port number to configure.
State	Select Enable/Disable to permit Port Security on the port.
Maximum MAC	The maximum number of MAC addresses allowed per interface. The acceptable range is 1 to 1000.
Apply	Click Apply to take effect the settings.
Refresh	Click Refresh to begin configuring this screen afresh.

7.7.2 Sticky Mac

Port security with sticky MAC addresses provides many of the same benefits as port security with static MAC addresses, but sticky MAC addresses can be learned dynamically. Port security with sticky MAC addresses retains dynamically learned MAC addresses during a link-down condition.

If you enter a **write memory** or **copy running-config startup-config** command, then port security with sticky MAC addresses saves dynamically learned MAC addresses in the startup-config file and the port does not have to learn addresses from ingress traffic after bootup or a restart.

7.7.2.1 CLI Configurations

Node	Command	Description
enable	show port-security	This command displays the current port security configurations.
enable	configure terminal	This command changes the node to configure node.
configure	interface IFNAME	This command enters the interface configure node.
interface	port-security mac-address sticky MACADDR vlan <1-4094>	This command configures a sticky MAC with a VLAN on the specific port.
interface	no port-security mac-address sticky MACADDR vlan <1-4094>	This command removes a sticky MAC with a VLAN for the specific port from the MAC table.
interface	port-security mac-address sticky	This command enables the stick function on the specific port.
interface	no port-security mac-address sticky	This command disables the stick function on the specific port.
config	interface range gigabitethernet1/0/ PORTLISTS	This command enters the if-range configure node.
if-range	port-security mac-address sticky	This command enables the stick function on the specific ports.
if-range	no port-security mac-address sticky	This command disables the stick function on the specific ports.

The procedures to enable port security with sticky MAC addresses on a port:

- To enable the global Port-Security.
L2SWITCH(config)#port-security enable
- To select the port you want to configure.
L2SWITCH(config)#interface gigabitethernet1/0/5
- To enable the port Port-Security.

L2SWITCH(config-if)#port-security enable

- To enable the sticky on the port.
L2SWITCH(config-if)#port-security mac-address sticky

7.7.2.2 Web Configurations

Port Security

Port Security
Sticky MAC Settings

Sticky MAC Settings

MAC Address	VLAN ID	Port
<input type="text"/>	<input type="text"/>	1 ▼

Sticky MAC Table

MAC Address	VLAN ID	Port	Action
Total Counts: 0			

Parameter	Description
Sticky MAC Settings	
MAC Address	Configures a Sticky MAC.
VLAN ID	Configures a VLAN for the Sticky MAC.
Port	Configures a port for the Sticky MAC.
Apply	Click Apply to take effect the settings.
Refresh	Click Refresh to begin configuring this screen afresh.
Sticky MAC Table	
Action	Clicks Delete to clear the sticky MAC.

7.8 TACACS+

The purpose of this enhancement is to support TACACS+ on the Switch platforms. Terminal Access Controller Access Control System Plus is a security application that provides centralized validation of users attempting to gain access to a router, network access server etc. In order for the TACACS+ feature on the VOLKTEK products to work it would need a TACACS+ server, which would typically be a daemon running on a centralized UNIX or windows NT authentication, authorization and accounting facilities for managing network access points from a single management service.

Product Features

The TACACS+ implementation will support the following features:

- The implementation will conform to version 1.78 of the TACACS+ draft RFC.
- Authentication, Authorization and Accounting can be run as well as disabled independently of each other.
- In case TACACS+ authentication fails on account of the server being unreachable the box can be made to default to a local authentication policy.
- TACACS+ packet body encryption will be supported.
- Single TACACS+ server will be support.
- Multiple connect mode will be support.
- Syslog messages will be support.

Functional Description

The TACACS+ implementation will provide the following services:

✓ Authentication:

Complete control of authentication through login and password dialog, challenge and response, messaging support etc.

✓ Authorization:

Control over user capabilities for the duration of the user session, like setting auto commands, enforcing restrictions on what configuration commands a user may execute, session duration etc.

✓ Accounting :

Collecting and sending information used for billing, auditing, and reporting to the TACACS+ daemon.

Each of the above mentioned services can be configured and run independent of the others. The TACACS+ implementation will provide authentication and confidentiality between the router and the TACACS+ daemon. It runs on TCP port 49.

Application:

Remote network access is witnessing a major paradigm shift that from terminal access to LAN access. Single users want to connect to the corporate network in the same way that they connect at work i.e. as a LAN user. This places increased emphasis on network access security. As a result of this network managers are concerned with 3 parameters: authentication, authorization

and accounting. This is where TACACS+ enters into the picture. A typical deployment using TACACS+ could be as follow:

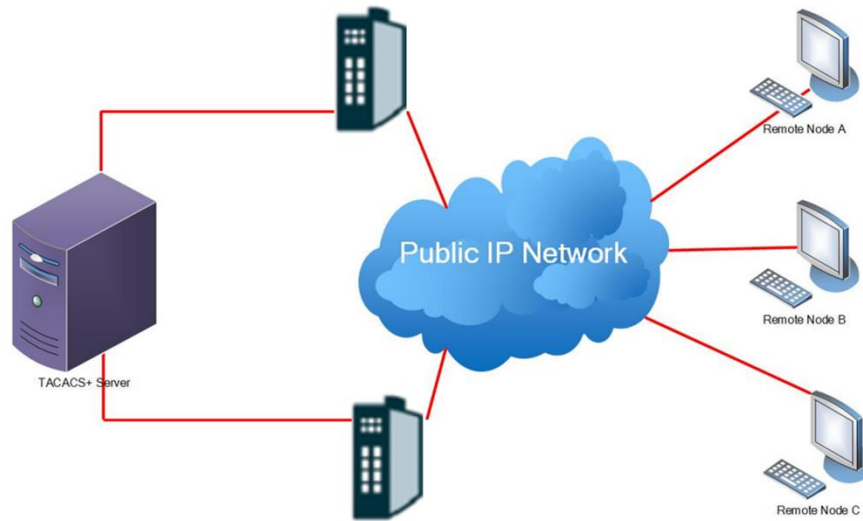

Notices

- TACACS+ service must be enabled before configuring the authentication, authorization and accounting parameters, otherwise it will return error as TACACS+ service is not enabled.
- Not allowed to disable the Authentication login mode when both enabled login-mode and login local.
- Not allowed to disable the Authentication enable mode when both enabled enable-mode and enable local.
- Not allowed to enable the login-mode local when login-mode is in disable.
- Not allowed to enable the enable-mode local when enable-mode is in disable.
- For input CLI, user must supply full command or partial command with TAB (command must be completed). The reason is only the command after user HIT the ENTER is only send to TACACS+ server for authorization or accounting. So if this command is partial then subsequently authorization or accounting fails.

7.8.1 CLI Configurations

Mode	Command	Description
enable	show tacacs-plus	To show the TACACS+ Statistics.
enable	configure terminal	This command changes the node to configure node.
configure	tacacs-plus server-host <ipaddr>	To set the TACACS+ Server ip address
configure	no tacacs-plus server-host	To reset the TACACS+ Server ip address as 0.0.0.0
configure	tacacs-plus server-key <key>	To set the TACACS+ server key

configure	no tacacs-plus server-key	To reset the TACACS+ server key as default key(NULL means no key)
configure	tacacs-plus enable	To enable the TACACS+ service
configure	no tacacs-plus enable	To disable the TACACS+ service
configure	tacacs-plus authentication login-mode enable	To enable the authentication login mode
configure	no tacacs-plus authentication login-mode enable	To disable the authentication login mode
configure	tacacs-plus authentication login-mode local enable	To enable the authentication login local mode
configure	no tacacs-plus authentication login-mode local enable	To disable the authentication login local mode
configure	tacacs-plus authentication enable-mode enable	To enable the authentication in enable mode.
configure	no tacacs-plus authentication enable-mode enable	To disable the authentication in enable mode.
configure	tacacs-plus authentication enable-mode local enable	To enable the authentication enable local mode
configure	no tacacs-plus authentication enable-mode local enable	To disable the authentication enable local mode
configure	tacacs-plus authorization commands enable	To enable the authorization show commands.
configure	no tacacs-plus authorization commands enable	To disable the authorization show commands.
configure	tacacs-plus authorization exec enable	To enable the authorization configuration commands.
configure	no tacacs-plus authorization exec enable	To disable the authorization configuration commands.
configure	tacacs-plus accounting commands enable	To enable the level 1 commands for accounting.
configure	no tacacs-plus accounting commands enable	To disable the level 1 commands for accounting.
configure	tacacs-plus accounting exec enable	To enable the level 15 commands for accounting.
configure	no tacacs-plus accounting exec enable	To disable the level15 commands for accounting
configure	tacacs-plus line-console enable	To enable TACACSP on the console port.
configure	no tacacs-plus line-console enable	To disable TACACSP on the console port.

Example:

```
L2SWITCH#show tacacs-plus
TACACS+ Server Host      :0.0.0.0
```

```

TACACS+ State           :disabled
TACACS+ line-console mode :disabled
Authentication Login mode :disabled           Local: disabled
Authentication Enable mode :disabled           Local: disabled
Authorization           :Command: disabled           Exec : disabled
Accounting               :Command: disabled           Exec : disabled
Authentication Sessions  :0
Authorization Sessions   :0
Accounting Sessions      :0
    
```

7.8.2 Web Configurations

TACACS+

Global Settings

State	<input type="text" value="Disable"/>		
Authentication Console Mode	<input type="text" value="Disable"/>		
Authentication Login Mode	<input type="text" value="Disable"/>	Local:	<input type="text" value="Disable"/>
Authentication Enable Mode	<input type="text" value="Disable"/>	Local:	<input type="text" value="Disable"/>
Authorization	Command: <input type="text" value="Disable"/>	Exec:	<input type="text" value="Disable"/>
Accounting	Command: <input type="text" value="Disable"/>	Exec:	<input type="text" value="Disable"/>
Primary TACACS Server	IP Version : <input type="text" value="Disable"/>	Server Address: <input type="text" value="0.0.0.0"/>	Server Key : <input type="text"/>
Secondary TACACS Server	IP Version : <input type="text" value="Disable"/>	Server Address: <input type="text" value="0.0.0.0"/>	Server Key : <input type="text"/>

Global Status

State	Disabled		
Authentication Console Mode	Disabled		
Authentication Login Mode	Disabled	Local: Disabled	
Authentication Enable Mode	Disabled	Local: Disabled	
Authorization	Command: Disabled	Exec: Disabled	
Accounting	Command: Disabled	Exec: Disabled	
Server Order	Primary TACACS Server		
Primary TACACS Server	IP Version:IPv4	Server Address :0.0.0.0	Server Key :
Secondary TACACS Server	IP Version:IPv4	Server Address :0.0.0.0	Server Key :

Parameter	Description
Global Settings	
State	Enables / Disables the TACACS+ service.
Authentication Console Mode	Enables / Disables the authentication in console mode.
Authentication Login Mode (TACACS+ server)	Enables / Disables the authentication in login mode. (this authentication is done by TACACS+ server)
Authentication Login Mode (Local)	Enables / Disables the authentication in login mode. (this authentication is done by switch when it cannot find TACACS+ server)
Authentication Enable Mode (TACACS+ server)	Enables / Disables the authentication in Enable mode. (this authentication is done by TACACS+ server)
Authentication Enable Mode (Local)	Enables / Disables the authentication in Enable mode. (this authentication is done by switch when it cannot find TACACS+ server)
Authorization Command	Enables / Disables the authorization with show commands.
Authorization Exec	Enables / Disables the authorization with configuration commands.
Accounting Command	Enables / Disables the level 1 command for the Accounting.
Accounting Exec	Enables / Disables the level 15 command for the Accounting.
TACACS Server IP Version	Select whether IPv4 or IPv6
TACACS Server IP	Configures the TACACS server's IP.
TACACS Server. Server Key	Configures the server key for the TACACS server.
Apply	Click Apply to take effect the settings.
Refresh	Click Refresh to begin configuring this screen afresh.

7.9 Denial of Service

A denial-of-service (DoS) attack is a type of cyberattack that aims to make a network resource unavailable to its intended users by temporarily or indefinitely disrupting services of a host connected to a network. The main goal of a DoS attack is to overwhelm the target system with an excessive amount of traffic or requests, causing it to slow down or crash, thereby preventing legitimate users from accessing the service.

7.9.1 CLI Configuration

Node	Command	Description
enable	show dos	This command displays the current settings of Denial of Service (DoS) function.
configure	dos tcp_null_scan [ACTION]	Sets tcp_null_scan option of DoS on the switch. <i>allow</i> : Allow TCP Null Scan. <i>deny</i> : Deny TCP Null Scan.
configure	dos tcp_syn_fin [ACTION]	Sets tcp_syn_fin option of DoS on the switch. <i>allow</i> : Allow TCP SYN/FIN Scan. <i>deny</i> : Deny TCP SYN/FIN Scan.
configure	dos tcp_syn_srcport_less_1024 [ACTION]	Sets tcp_syn_srcport_less_1024 option of DoS on the switch. <i>allow</i> : Allow TCP SYN SrcPort less 1024. <i>deny</i> : Deny TCP SYN SrcPort less 1024.
configure	dos tcp_xmascan [ACTION]	Sets tcp_xmascan option of DoS on the switch. <i>allow</i> : Allow TCP Xmascan. <i>deny</i> : Deny TCP Xmascan.

7.9.1.1 CLI Configuration

```
L2SWITCH#show dos
```

```
Denial of Service
```

```
-----
```

```
TCP Null Scan: Allow
```

```
TCP Xmascan: Allow
```

```
TCP SYN/FIN: Allow
```

```
TCP SYN SrcPort less 1024: Allow
```

7.9.2 Web Configuration

Denial of Service

DoS Settings

TCP Null Scan	<input type="text" value="Allow"/>
TCP Xmascan	<input type="text" value="Allow"/>
TCP SYN/FIN	<input type="text" value="Allow"/>
TCP SYN SrcPort less 1024	<input type="text" value="Allow"/>

Parameter	Description
DoS Settings	
TCP Null Scan	Select Deny if you want to deny TCP Null Scan. Otherwise, select Allow to allow TCP Null Scan.
TCP Xmascan	Select Deny if you want to deny TCP Xmascan. Otherwise, select Allow to allow TCP Xmascan.
TCP SYN/FIN	Select Deny if you want to deny TCP SYN/FIN. Otherwise, select Allow to allow TCP SYN/FIN.
TCP SYN SrcPort less 1024	Select Deny if you want to deny TCP SrcPort less 1024. Otherwise, select Allow to allow TCP Source Port less 1024.

8 Monitor

8.4 Alarm

The feature displays if there are any abnormal situation need process immediately.

Notice: The Alarm DIP switch allow users to configure if send alarm message when the corresponding event occurs.

For Example:

P1: ON, The Switch will send alarm message when port 1 is link down.

PWR: ON, The Switch will send alarm message when the main power supply disconnect.

RPS: ON, The Switch will send alarm message when the redundant power supply disconnect.

8.4.1 CLI Configurations

Node	Command	Description
enable	show alarm-info	This command displays alarm information.

8.4.2 Web Configurations

Alarm

Alarm Information

Alarm Status	No Alarm.
Alarm Reason(s)	

DIP switch Settings

DIP Switch	Status	DIP Switch	Status
PWR	Disable	RPS	Disable

Parameter	Description
Alarm Information	
Alarm Status	This field indicates if there is any alarm events.
Alarm Reason(s)	This field displays all of the detail alarm events.
DIP switch Settings	
DIP Switch	The field displays the DIP Switch name.
Status	The field indicates the DIP Switch current status.
Refresh	Click Refresh to begin configuring this screen afresh.

8.5 Hardware Information

The feature displays some hardware information to monitor the system to guarantee the network correctly.

- A. Displays the board's and CPU's and MAC chip's temperature.
- B. Displays the 1.0V and 2.5V and 3.3V input status.

8.5.1 CLI Configurations

Node	Command	Description
enable	show hardware-monitor (C/F)	This command displays hardware working information.

Example:

L2SWITCH#show hardware-monitor C

Temperature(C)	Current	MAX	MIN	Threshold	Status
BOARD	44.0	44.2	24.0	80.0	Normal
CPU	49.2	49.2	26.5	80.0	Normal
PHY	57.5	57.5	30.0	80.0	Normal

Voltage(V)	Current	MAX	MIN	Threshold	Status
1.0V IN	1.009	1.009	1.009	+/-5%	Normal
1.8V IN	1.768	1.778	1.755	+/-5%	Normal
3.3V IN	3.264	3.264	3.259	+/-5%	Normal

8.5.2 Web Configurations

Hardware Information

Hardware Information

Temperature Unit: ▾

Hardware Monitor Alarm: ▾

Hardware Working Information:

Temperature(C)	Current	MAX	MIN	Threshold	Status
BOARD	50.2	50.2	50.2	80.0	Normal
CPU	50.8	50.8	50.8	80.0	Normal
PHY	48.0	48.0	48.0	80.0	Normal
Voltage(V)	Current	MAX	MIN	Threshold	Status
1.0V IN	0.988	0.988	0.988	+/-6%	Normal
1.8V IN	1.777	1.777	1.777	+/-6%	Normal
5.0V IN	5.017	5.017	5.017	+/-6%	Normal

Parameter	Description
Hardware Information	
Temperature unit	This field allows you to select unit in Celsius (C) or Fahrenheit (F).
Hardware monitor alarm	This field allows to enable/disable the hardware-Monitor alarm to be reported or not.
Hardware Working Information	
Temperature	The field displays the temperature information of board, CPU and PHY
Voltage	The field indicates the voltage level status.
Apply	Click Apply to take effect the settings.
Refresh	Click Refresh to begin configuring this screen afresh.

8.6 Port Statistics

This feature helps users to monitor the ports' statistics, to display the link up ports' traffic utilization only.

8.6.1 CLI Configurations

Node	Command	Description
enable	show port-statistics	This command displays the link up ports' statistics.

Example:

```
L2SWITCH#show port-statistics
```

Port	Packets		Bytes		Errors		Drops	
	Rx	Tx	Rx	Tx	Rx	Tx	Rx	Tx
7	1154	2	108519	1188	0	0	0	0

8.6.2 Web Configurations

Port Statistics

Port Statistics

Port	Receive Drops	Transmit Drops	Receive Errors	Transmit Errors	Receive Packets	Transmit Packets	Receive Bytes	Transmit Bytes
8	0	0	0	0	1089	1022	170050	1149135

Parameter	Description
Port Statistics	
Port	Select a port or a range of ports to display their statistics.
Receive Drops	The field displays the received drop count.
Transmit Drops	The field displays the transmitted drop count.
Receive Errors	The field displays the received error count.
Transmit Errors	The field displays the transmitted error count.
Receive Packets	The field displays the received packet count.
Transmit Packets	The field displays the transmitted packet count.
Receive Bytes	The field displays the received byte count.
Transmit Bytes	The field displays the transmitted byte count.
Refresh	Click Refresh to begin configuring this screen afresh.

Clear

Click **Clear** to clear all of statistics.

8.7 Port Utilization

This feature helps users to monitor the ports' traffic utilization, to display the link up ports' traffic utilization only.

8.7.1 CLI Configuration

Node	Command	Description
enable	show port-utilization (bps Kbps Mbps)	This command displays the link up ports' traffic utilization.

8.7.2 Web Configuration

Port Utilization

Port Utilization

Unit:

Port	Speed	Rx Utilization (%)	Rx Utilization (bps)	Tx Utilization (%)	Tx Utilization (bps)
1	1000	0.00	17264	0.00	6421

Parameter	Description
Port Utilization	
Unit	Select a unit for displaying the port utilization.
Port	Select a port or a range of ports to display their RMON statistics.
Speed	The current port speed.
Rx Utilization (%)	The port receiving traffic utilization in percentage
Rx Utilization (bps)	The port receiving traffic utilization in bits per second
Tx Utilization (%)	The port transmitting traffic utilization in percentage
Tx Utilization (bps)	The port transmitting traffic utilization in bits per second
Apply	Click Apply to take effect the settings.
Refresh	Click Refresh to begin configuring this screen afresh.

8.8 RMON Statistics

This feature helps users to monitor or clear the port's RMON statistics.

8.8.1 CLI Configuration

Node	Command	Description
enable	show rmon statistics	This command displays the RMON statistics.
enable	configure terminal	This command changes the node to configure node.
configure	clear rmon statistics [IFNAME]	This command clears one port's or all ports' RMON statistics.

8.8.2 Web Configuration

RMON Statistics

RMON Statistics

Port

Port 1 (Active)			
Inbound	Total Octets	798911	
	BroadcastPkts	750	UnicastPkts 1438
	Non-unicastPkts	2172	MulticastPkts 1422
	FragmentsPkts	0	UndersizePkts 0
	OversizePkts	0	DiscardsPkts 0
	ErrorPkts	0	UnknownProtos 0
	AlignError	0	CRCAlignErrors 0
	Jabbers	0	DropEvents 0
Outbound	Total Octets	855314	
	BroadcastPkts	2	UnicastPkts 1245
	Non-unicastPkts	66	Collisions 0
	LateCollision	0	SingleCollision 0
	MultipleCollision	0	DiscardsPkts 0
	ErrorPkts	0	
# of packets received with a length of	64 Octets	1562	65to127 Octets 1456
	128to255 Octets	277	256to511 Octets 409
	512to1023 Octets	722	1024toMax Octets 495

Parameter	Description
RMON Statistics	
Port	Select a port or a range of ports to display their RMON statistics.
Show	Show them.

Clear	Clear the RMON statistics for the port or a range of ports.
-------	---

8.9 SFP Information

The SFP information allows user to know the SFP module’s information, such as vendor name, connector type, revision, serial number, manufacture date, and to know the DDMI information if the SFP modules have supported the DDMI function.

8.9.1 CLI Configurations

Node	Command	Description
enable	show sfp info port PORT_ID	This command displays the SFP information.
enable	show sfp ddmi port PORT_ID	This command displays the SFP DDMI status.

8.9.2 Web Configurations

SFP Information

SFP Information

Port

SFP Information	
Fiber Cable	N/A
Connector	N/A
Wavelength(nm)	N/A
Transfer Distance	N/A
DDM Supported	N/A
Vendor Name	N/A
Vendor PN	N/A
Vendor rev	N/A
Vendor SN	N/A
Date code	N/A

Parameter	Description
SFP Information	
Port	Select a port number to configure.
Apply	Click Apply to display the SFP information.
SFP Information	
Fiber Cable	To indicate if the fiber cable is connected.
Connector	Code of optical connector type.

Vendor Name	SFP vendor name.
Vendor PN	Part Number.
Vendor rev	Revision level for part number.
Vendor SN	Serial number (ASCII).
Date Code	Manufacturing date code.

Notice: If the fiber cable is not connected, the Rx Power fields are not available.

8.10 Traffic Monitor

The function can be enabled / disabled on a specific port or globally be enabled disabled on the Switch. The function will monitor the broadcast / multicast / broadcast and multicast packets rate. If the packet rate is over the user's specification, the port will be blocked. And if the recovery function is enabled, the port will be enabled after recovery time.

User can configure the recovery time and quarantine times. If a port is blocked by this function, after the time period recovery time, the port isolated first and continue monitored X times(X=quarantine times). If storm traffic is under packet rate all times monitored, the port will be enabled and be monitored again.

When a port is blocked by this function, the Switch will record a log message in local database or syslog server and send a trap to trap receiver and turn on the ALM LED..

8.10.1 CLI Configurations

Node	Command	Description
enable	show traffic-monitor	This command displays the traffic monitor configurations and current status.
enable	configure terminal	This command changes the node to configure node.
configure	traffic-monitor (disable enable)	This command enables / disables the traffic monitor on the Switch.
configure	interface IFNAME	This command enters the interface configure node.
interface	traffic-monitor (disable enable)	This command enables / disables the traffic monitor on the port.
interface	traffic-monitor rate RATE_LIMIT type (bcast mcast bcast+mc ast)	This command configures the packet rate and packet type for the traffic monitor on the port. bcast – Broadcast packets. mcast – Multicast packets. bcast+ mcast - Broadcast packets and Multicast packets.
interface	traffic-monitor recovery (disable enable)	This command enables / disables the recovery function for the traffic monitor on the port.
interface	traffic-monitor recovery time <1-60>	This command configures the recovery time for the traffic monitor on the port.

interface	traffic-monitor quarantine times <1-20>	This command configures the quarantine times for the traffic monitor on the port.
configure	interface range gigabitethernet1/0/ PORTLISTS	This command enters the if-range configure node.
if-range	traffic-monitor (disable enable)	This command enables / disables the traffic monitor on the port.
if-range	traffic-monitor rateRATE_LIMIT type (bcast mcast bcast+mcast)	This command configures the packet rate and packet type for the traffic monitor on the port. bcast – Broadcast packets. mcast – Multicast packets. bcast+ mcast - Broadcast packets and Multicast packets.
if-range	traffic-monitor recovery (disable enable)	This command enables / disables the recovery function for the traffic monitor on the port.
if-range	traffic-monitor recovery time <1-60>	This command configures the recovery time for the traffic monitor on the port.
if-range	traffic-monitor quarantine times <1-20>	This command configures the quarantine times for the traffic monitor on the port.

8.10.2 Web Configurations

Traffic Monitor

Traffic Monitor Settings

State Disable ▾

Port	State	Packet Type	Packet Rate(pps)	Recovery State	Recovery Time(min)	Quarantine Times
From: 1 ▾ To: 1 ▾	Disable ▾	Broadcast ▾	<input style="width: 50px;" type="text" value="100"/>	Enable ▾	<input style="width: 50px;" type="text" value="1"/>	<input style="width: 50px;" type="text" value="3"/>

Apply
Refresh

Port	Manual Recovery
From: 1 ▾ To: 1 ▾	None ▾

Apply

Traffic Monitor Status

Port	State	Status	Packet Type	Packet Rate(pps)	Recovery State	Recovery Time(min)	Quarantine Times
1	Disabled	Normal	Broadcast	100	Enabled	1	3
2	Disabled	Normal	Broadcast	100	Enabled	1	3
3	Disabled	Normal	Broadcast	100	Enabled	1	3
4	Disabled	Normal	Broadcast	100	Enabled	1	3
5	Disabled	Normal	Broadcast	100	Enabled	1	3
6	Disabled	Normal	Broadcast	100	Enabled	1	3
7	Disabled	Normal	Broadcast	100	Enabled	1	3
8	Disabled	Normal	Broadcast	100	Enabled	1	3
9	Disabled	Normal	Broadcast	100	Enabled	1	3
10	Disabled	Normal	Broadcast	100	Enabled	1	3
11	Disabled	Normal	Broadcast	100	Enabled	1	3
12	Disabled	Normal	Broadcast	100	Enabled	1	3

Parameter	Description
Traffic Monitor Settings	
State	Globally enables / disables the traffic monitor function.
Port	The port range which you want to configure.
State	Enables / disables the traffic monitor function on these ports.
Packet Type	Specify the packet type which you want to monitor.
Packet Rate	Specify the packet rate which you want to monitor.
Recover State	Enables / disables the recovery function for the traffic monitor

	function on these ports.
Recovery Time	Configures the recovery time for the traffic monitor function on these ports.(Range: 1 – 60 minutes)
Quarantine Times	Configures the quarantine times for the traffic monitor on these ports. (Range: 1 – 20 times)
Apply	Click Apply to take effect the settings.
Refresh	Click Refresh to begin configuring this screen afresh.
Manual Recovery	Select Unblock to enable these ports blocked by traffic monitor.
Apply	Click Apply to take effect the settings.

8.11 Traffic Monitor

The sFlow is an industry standard for monitoring high-speed switched and routed networks. It was originally developed by InMon Corp. It provides a means for exporting truncated packets, together with interface counters for the purpose of network monitoring.

8.11.1 CLI Command

Node	Command	Description
enable	show sflow	Display sflow configure of agent and collector.
enable	show sflow interface	Display sflow configure of all interface
configure	sflow (disable enable) id <1-2>	Enable/Disable sflow agent
configure	sflow agent ip <IPv4 address>	Configure agent IP address.
configure	no sflow agent	Delete agent IP address..
configure	sflow collector id <1-2> ip STRINGS port <1-65535> datagram-size <200-1500>	Configure sFlow Collector .
configure	no sflow collector id <1-2>	Delete the configuration of sFlow collector.
configure	sflow flow-sampling (ingress egress) id <1-2> rate <256-1073741823> hdr-size <18-512>	Configure sFlow flow sampling.
configure	no sflow flow-sampling	Delete the configure of sFlow flow sampling.
configure	sflow counter-sampling id <1-2> interval <2-86400>	Configure sFlow counter sampling.
configure	no sflow counter-sampling	Disable counter sampling

8.11.1.1 CLI Command Example

```
L2SWITCH# show sflow
L2SWITCH# show sflow interface
```

8.11.2 Web Configuration

8.11.2.1 General Settings

sFlow Monitor

General Settings
Flow Sampling Settings
Counter Sampling Settings

Agent Settings

IP Address

Receiver Settings

Receiver ID	State	IP Address	Max Datagram Size	Port
1 ▾	Disable ▾	<input type="text"/>	1400	6343

Receiver Status

Receiver ID	State	IP Address	Max Datagram Size	Port
1	Disabled	0.0.0.0	1400	6343
2	Disabled	0.0.0.0	1400	6343

Parameter	Description
Agent Settings	
IP Address	It must set as management IP
Receiver Setting	
Receiver ID	Configure remote Receiver Server ID.
State	Enable/Disable send information to Remote Receiver.
IP Address	Configure Remote Receiver Server IP Address.
Max Datagram Size	Maximum size of the sFlow datagram payload(Range 200-1500)
Port	Remote Receiver port (default Port:6343)

8.11.2.2 Flow Sampling Settings

sFlow Monitor

General Settings
Flow Sampling Settings
Counter Sampling Settings

Flow Sampling Setting

Port	Receiver ID	State	Mode	Sampling Rate	Header Bytes
From: <input type="text" value="1"/> To: <input type="text" value="1"/>	<input type="text" value="None"/>	<input type="text" value="Disable"/>	<input type="text" value="Ingress"/>	<input type="text" value="1024"/>	<input type="text" value="64"/>

Port Sampling Status

Port	Flow Sampling				
	Receiver ID	State	Mode	Sampling Rate	Header Bytes
1	1	Disabled	Ingress	1/1024	64
2	1	Disabled	Ingress	1/1024	64
3	1	Disabled	Ingress	1/1024	64
4	1	Disabled	Ingress	1/1024	64
5	1	Disabled	Ingress	1/1024	64
6	1	Disabled	Ingress	1/1024	64
7	1	Disabled	Ingress	1/1024	64
8	1	Disabled	Ingress	1/1024	64
9	1	Disabled	Ingress	1/1024	64
10	1	Disabled	Ingress	1/1024	64
11	1	Disabled	Ingress	1/1024	64
12	1	Disabled	Ingress	1/1024	64

Parameter	Description
Port	Switch Port Number
Receiver ID	Assign remote Receiver Server ID.
State	Enable/Disable flow sampling function.
Mode	sFlow Packet Sampling Type
Sampling Rate	The number of packets out of which switch will sampling a packet.
Header Byte	The maximum header size of packet to be copied.

8.11.2.3 Count Sampling Settings

sFlow Monitor

General Settings
Flow Sampling Settings
Counter Sampling Settings

Counter Sampling Setting

Port	Receiver ID	State	Interval
From: <input type="text" value="1"/> To: <input type="text" value="1"/>	<input type="text" value="None"/>	<input type="text" value="Disable"/>	<input type="text" value="10"/> Sec

Port Sampling Status

Port	Counter Sampling		
	Receiver ID	State	Interval
1	1	Disabled	10
2	1	Disabled	10
3	1	Disabled	10
4	1	Disabled	10
5	1	Disabled	10
6	1	Disabled	10
7	1	Disabled	10
8	1	Disabled	10
9	1	Disabled	10
10	1	Disabled	10
11	1	Disabled	10
12	1	Disabled	10

Parameter	Description
Port	Switch Port Number
Receiver ID	Assign remote Receiver Server ID.
State	Enable/Disable flow sampling function.
Interval	Counter Poll interval in second

9 Management

9.4 SNMP

Simple Network Management Protocol (SNMP) is used in network management systems to monitor network-attached devices for conditions that warrant administrative attention. SNMP is a component of the Internet Protocol Suite as defined by the Internet Engineering Task Force (IETF). It consists of a set of standards for network management, including an application layer protocol, a database schema, and a set of data objects.

SNMP exposes management data in the form of variables on the managed systems, which describe the system configuration. These variables can then be queried (and sometimes set) by managing applications.

Support below MIBs:

- RFC 1157 A Simple Network Management Protocol
- RFC 1213 MIB-II
- RFC 1493 Bridge MIB
- RFC 1643 Ethernet Interface MIB
- RFC 1757 RMON Group 1,2,3,9

SNMP community act like passwords and are used to define the security parameters of SNMP clients in an SNMP v1 and SNMP v2c environments. The default SNMP community is “public” for both SNMP v1 and SNMP v2c before SNMP v3 is enabled. Once SNMP v3 is enabled, the communities of SNMP v1 and v2c have to be unique and cannot be shared.

Network ID of Trusted Host:

The IP address is a combination of the Network ID and the Host ID.

Network ID = (Host IP & Mask).

User need only input the network ID and leave the host ID to 0. If user has input the host ID, such as 192.168.1.102, the system will reset the host ID, such as 192.168.1.0

Note: Allow user to configure the community string and rights only.

User configures the Community String and the Rights and the Network ID of Trusted Host=0.0.0.0, Subnet Mask=0.0.0.0. It means that all hosts with the community string can access the Switch.

Default Settings

- SNMP : disabled.
- System Location : L2SWITCH. (Maximum length 64 characters)
- System Contact : None. (Maximum length 64 characters)
- System Name : None. (Maximum length 64characters)
- Trap Receiver : None.
- Community Name : None.
- The maximum entry for community : 3.
- The maximum entry for trap receiver : 5.

9.4.1 SNMP

9.4.1.1 SNMP Settings

9.4.1.1.1 CLI Configurations

Node	Command	Description
enable	show snmp	This command displays the SNMP configurations.
enable	configure terminal	This command changes the node to configure node.
configure	snmp (disable enable)	This command disables/enables the SNMP on the switch.
configure	snmp system-contact STRING	This command configures contact information for the system.
configure	snmp system-location STRING	This command configures the location information for the system.
configure	snmp system-name STRING	This command configures a name for the system. (The System Name is same as the host name)
configure	no snmp system-contact STRING	This command resets the contact information for the system.
configure	no snmp system-location STRING	This command resets the location information for the system.
configure	no snmp system-name STRING	This command resets the system name for the system.

Example:

```
L2SWITCH#configure terminal
L2SWITCH(config)#snmp enable
L2SWITCH(config)#snmp community public rw trusted-host 192.168.200.106/24
L2SWITCH(config)#snmp trap-receiver 192.168.200.106 v2c public
L2SWITCH(config)#snmp system-contact IT engineer
L2SWITCH(config)#snmp system-location Branch-Office
```

9.4.1.1.2 Web Configurations

SNMP

SNMP Settings
Community Name

SNMP Settings

SNMP State:

System Name:

System Location:

System Contact:

Parameter	Description
-----------	-------------

SNMP State	Select Enable to activate SNMP on the Switch. Select Disable to not use SNMP on the Switch.
System Name	Type a System Name for the Switch. (The System Name is same as the host name)
System Location	Type a System Location for the Switch.
System Contact	Type a System Contact for the Switch.
Apply	Click Apply to take effect the settings.
Refresh	Click Refresh to begin configuring this screen afresh.

9.4.1.2 Community Name

9.4.1.2.1 CLI Configurations

Node	Command	Description
enable	show snmp	This command displays the SNMP configurations.
enable	configure terminal	This command changes the node to configure node.
configure	snmp community STRING (ro rw) trusted-host IPADDR	This command configures the SNMP community name.

9.4.1.2.2 Web Configurations

SNMP

SNMP Settings
Community Name

Community Name Settings

Community String	Rights	IP Version	Network ID of Trusted Host	Number of Mask Bit
<input type="text"/>	Read-Only ▾	IPv4 ▾	<input type="text"/>	<input type="text"/>

Community Name List

No.	Community String	Rights	IP Version	Network ID of Trusted Host	Number of Mask Bit	Action
-----	------------------	--------	------------	----------------------------	--------------------	--------

Parameter	Description
Community Name Settings	
Community String	Enter a Community string, this will act as a password for requests from the management station. An SNMP community string is a text string that acts as a password. It is used to authenticate messages that are sent between the management station (the SNMP manager) and the device (the SNMP

	agent). The community string is included in every packet that is transmitted between the SNMP manager and the SNMP agent.
Rights	Select Read-Only to allow the SNMP manager using this string to collect information from the Switch. Select Read-Write to allow the SNMP manager using this string to create or edit MIBs (configure settings on the Switch).
Network ID of Trusted Host	Type the IP address of the remote SNMP management station in dotted decimal notation, for example 192.168.1.0.
Mask	Type the subnet mask for the IP address of the remote SNMP management station in dotted decimal notation, for example 255.255.255.0.
Apply	Click Apply to take effect the settings.
Refresh	Click Refresh to begin configuring this screen afresh.
Community Name List	
Action	Click Delete to remove a specific Community String.

9.4.2 SNMP Trap

9.4.2.1 Trap Receiver

9.4.2.1.1 CLI Configurations

Node	Command	Description
enable	show snmp	This command displays the SNMP configurations.
enable	configure terminal	This command changes the node to configure mode.
configure	snmp trap-receiver IPADDR (v1 v2c) COMMUNITY	This command configures the trap receiver's configurations, including the IP address, version (v1 or v2c) and community.
configure	snmp trap-ipv6-receiver IPADDR (v1 v2c) COMMUNITY	This command configures the trap IPv6 receiver's configurations, including the IP address, version (v1 or v2c) and community.

9.4.2.1.2 Web Configurations

SNMP Trap

Trap Receiver
Trap Event
Port Trap Event

Trap Receiver Settings

IP Version	IP Address	Version	Community String
IPv4 ▼	<input type="text"/>	v1 ▼	<input type="text"/>

Trap Receiver List

No.	IP Version	IP Address	Version	Community String	Action

Parameter	Description
IP Address	Enter the IP address of the remote trap station in dotted decimal notation.
Version	Select the version of the Simple Network Management Protocol to use. v1 or v2c .
Community String	Specify the community string used with this remote trap station.
Apply	Click Apply to take effect the settings.
Refresh	Click Refresh to begin configuring this screen afresh.
Trap Receiver List	
Action	Click Delete to remove a configured trap receiver station.

9.4.2.2 Trap Event

The features allow users to enable/disables individual trap notification.

alarm-over-heat	- Trap when system's temperature is too high.
alarm-over-load	- Trap when system is over load.
alarm-power-fail	- Trap when system power is over voltage/under voltage/ RPS over voltage/RPS under voltage.
bpdu	- Trap when port is blocked by BPDU Guard/BPDU Root Guard/BPDU port state changed.
dual-homing	- Trap when port is blocked by Dual Homing.
dying-gasy	- Trap when system is power off.
loop-detection	- Trap when port is blocked by Loop Detection.
pd-alive	- Trap when PD device has no responses.
port-admin-state-change	- Trap when port is enabled/disable by administrator.
port-link-change	- Trap when port is link up/down change.
power-source-change	- Trap when the power source has been changed. (AC to DC or DC to AC)
stp-topology-change	- Trap when the STP topology change.
traffic-monitor	- Trap when port is blocked by Traffic Monitor.
xpress-ring	- Trap when port is blocked by Xpress Ring.

9.4.2.2.1 CLI Configurations

Node	Command	Description
enable	show snmp trap-event	This command displays the SNMP configurations.
enable	configure terminal	This command changes the node to configure node.
configure	snmp trap-event alarm-over-heat (disable/enable)	This command enables/disables the alarm-over-heat trap.
configure	snmp trap-event alarm-over-load (disable/enable)	This command enables/disables the alarm-over-load trap.
configure	snmp trap-event alarm-power-fail (enable/enable)	This command enables/disables the alarm-power-fail trap.
configure	snmp trap-event bpdu (disable/enable)	This command enables/disables the BPDU port state change/BPDU Root Guard/BPDU Guard trap.
configure	snmp trap-event dual-homing (disable/enable)	This command enables/disables the dual-homing trap.
configure	snmp trap-event dying-gasp (disable/enable)	This command enables/disables the dying-gasp trap.
configure	snmp trap-event loop-detection (disable/enable)	This command enables/disables the loop-detection trap.
configure	snmp trap-event pd-alive (disable/enable)	This command enables/disables the PD alive trap.
configure	snmp trap-event port-admin-state-change	This command enables/disables the port-admin-state-change trap.

	(disable/enable)	
configure	snmp trap-event port-link-change (disable/enable)	This command enables/disables the port-link-change trap.
configure	snmp trap-event power-source-change (disable/enable)	This command enables/disables the power-source-change trap.
configure	snmp trap-event stp-topology-change (disable/enable)	This command enables/disables the stp-topology-change trap.
configure	snmp trap-event traffic-monitor (disable/enable)	This command enables/disables the traffic-monitor trap.
configure	snmp trap-event xpress-ring (disable/enable)	This command enables/disables the xpress-ring trap.

9.4.2.2.2 Web Configurations

SNMP Trap

Trap Receiver
Trap Event
Port Trap Event

Trap Event Settings

Select All
 Deselect All

- Alarm-Over-Heat
- Alarm-Over-Load
- Alarm-Power-Fail
- BPDU-Guard
- Dual-Homing
- Loop-Detection
- PD-Alive
- Port-Admin-State-Change
- Port-Link-Change
- STP-Topology-Change
- Traffic-Monitor
- Xpress-Ring

Parameter	Description
Trap Event State Settings	
Select all	Enables all of trap events.
Deselect All	Disables all os trap events.
Apply	Click Apply to take effect the settings.
Refresh	Click Refresh to begin configuring this screen afresh.

9.4.2.3 Port Trap Event

The features allow users to enable/disable port-link-change trap notification by individual port.

9.4.2.3.1 CLI Configurations

Node	Command	Description
enable	show snmp port-link-change-trap	This command displays the SNMP port link-change trap configurations.
enable	configure terminal	This command changes the node to configure node.
configure	interface IFNAME	This command enters the interface configure node.
interface	snmp port-link-change-trap	This command enables the link change trap on the specific port.
interface	no snmp port-link-change-trap	This command disables the link change trap on the specific port.
configure	interface range gigabitethernet1/0/PORTLISTS	This command enters the if-range configure node.
if-range	snmp port-link-change-trap	This command enables the link change trap on the specific ports.
if-range	no snmp port-link-change-trap	This command disables the link change trap on the specific ports.

9.4.2.3.2 Web Configurations

SNMP Trap

Trap Receiver
Trap Event
Port Trap Event

Port Link-Change Trap Settings

Port	State
From: <input type="text" value="1"/> <input type="text" value="To: 1"/>	<input type="text" value="Enable"/>

Port Link-Change Trap Status

Port	State	Port	State
1	Enabled	2	Enabled
3	Enabled	4	Enabled
5	Enabled	6	Enabled
7	Enabled	8	Enabled
9	Enabled	10	Enabled
11	Enabled	12	Enabled

Parameter	Description
-----------	-------------

Trap Event State Settings	
----------------------------------	--

Port	Selects the range of ports.
State	Selects the state for the ports..
Apply	Click Apply to take effect the settings.
Refresh	Click Refresh to begin configuring this screen afresh.

9.4.3 SNMPv3

9.4.3.1 Group Settings

9.4.3.1.1 CLI Configurations

Node	Command	Description
enable	show snmp group	This command displays all snmp v3 groups.
enable	configure terminal	This command changes the node to configure node.
configure	snmp group GROUPNAME noauth (read STRINGS write STRINGS notify STRINGS)	Configures v3 group of non- authentication.
configure	snmp group GROUPNAME auth (read STRINGS write STRINGS notify STRINGS)	Configures v3 group of authentication.
configure	snmp group GROUPNAME priv (read STRINGS write STRINGS notify STRINGS)	Configures v3 group of authentication and encryption.
configure	no snmp group GROUPNAME	This command removes a v3 group from switch.

9.4.3.1.2 Web Configurations

SNMPv3

Group Settings
User Settings
View Settings

Group Settings

Group Name

Security Level

Read View

Write View

Notify View

Group Status

Group Name	Security Model	Security Level	Read View	Write View	Notify View	Action
Empty!						

Parameter	Description
Group Name	Enter the v3 user name.
Security Level	Select the security level of the v3 group to use.
Read View	Note that if a group is defined without a read view than all objects are available to read. (default value is none .)
Write View	if no write or notify view is defined, no write access is granted and no objects can send notifications to members of the group. (default value is none .)
Notify View	By using a notify view, a group determines the list of notifications its users can receive.(default value is none .)
Apply	Click Apply to take effect the settings.
Refresh	Click Refresh to begin configuring this screen afresh.
SNMPv3 Group Status	
Group Name	This field displays the v3 user name.
Security Model	This field displays the security model of the group. Always displayed v3: User-based Security Model (USM)
Security Level	This field displays the security level to this group.
Read View	These fields display the View list of this group.

Write View	
Notify View	
Action	Click Delete to remove a v3 group.

9.4.3.2 User Settings

9.4.3.2.1 CLI Configurations

Node	Command	Description
enable	show snmp user	This command displays all snmp v3 users.
enable	configure terminal	This command changes the node to configure node.
configure	snmp user USERNAME GROUPNAME noauth	Configures v3 user of non- authentication.
configure	snmp user USERNAME GROUPNAME auth (MD5 SHA) STRINGS	Configures v3 user of authentication.
configure	snmp user USERNAME GROUPNAME priv (MD5 SHA) STRINGS des STRINGS	Configures v3 user osnmf authentication and encryption.
configure	no snmp user USERNAME GROUPNAME	This command removes a v3 user from switch.

9.4.3.2.2 Web Configurations

SNMPv3

Group Settings
User Settings
View Settings

User Settings

Username

Group Name

Security Level noauth ▼

Auth Algorithm MD5 ▼

Auth Password

Priv Algorithm DES ▼

Priv Password

User Status

Username	Group Name	Auth Protocol	Priv Protocol	Rowstatus	Action
Empty!					

Parameter	Description
User Name	Enter the v3 user name.
Group Name	Map the v3 user name into a group name.
Security Level	Select the security level of the v3 user to use. noauth means no authentication and no encryption. auth means messages are authenticated but not encrypted. priv means messages are authenticated and encrypted.
Auth Algorithm	Select MD5 or SHA Algorithm when security level is auth or priv .
Auth Password	Set the password for this user when security level is auth or priv . (pass phrases must be at least 8 characters long!)
Priv Algorithm	Select DES encryption when security level is priv .
Priv Password	Set the password for this user when security level is priv . (pass phrases must be at least 8 characters long!)
Apply	Click Apply to take effect the settings.
Refresh	Click Refresh to begin configuring this screen afresh.
SNMPv3 User Status	
User Name	This field displays the v3 user name.

Group Name	This field displays the group name which the v3 user mapping.
Auth Protocol	These fields display the security level to this v3 user.
Priv Protocol	
Rowstatus	This field displays the v3 user row status.
Action	Click Delete to remove a v3 user.

9.4.3.3 View Settings

9.4.3.3.1 CLI Configurations

Node	Command	Description
enable	show snmp view	This command displays all snmp v3 view.
enable	configure terminal	This command changes the node to configure node.
configure	snmp view VIEWNAME STRINGS (included excluded)	To identify the subtree.
configure	no snmp view VIEWNAME STRINGS	This command removes a v3 view from switch.

9.4.3.3.2 Web Configurations

SNMPv3

Group Settings
User Settings
View Settings

View Settings

View Name

View Subtree

View Type included ▼

View Status

View Name	View Subtree	View Type	Action
Empty!			

Parameter	Description
View Settings	
View Name	Enter the v3 view name for creating an entry in the SNMPv3 MIB view table.

View Subtree	The OID defining the root of the subtree to add to (or exclude from) the named view.
View Type	Select included or excluded to define subtree adding to the view or not.
Apply	Click Apply to take effect the settings.
Refresh	Click Refresh to begin configuring this screen afresh.
View Status	
View Name	This field displays the v3 view name.
View Subtree	This field displays the subtree.
View Type	This field displays the subtree adding to the view or not.
Action	Click Delete to remove a v3 view.

9.5 Auto Provision

Auto provision is a service that service provider can quickly, easily and automatically configure remote device or doing firmware upgrade at remote side.

1. When the Auto Provision is enabled, the Switch will download the auto provision information file from the auto provision server first.

The file name is followed below naming rule:

Model_Name_Autoprovision.txt

For Example: **IEN-8648_Autoprovision.txt**

The contents of the file are listed below:

```
AUTO_PROVISION_VER=1
Firmware_Upgrade_State=1
Firmware_Version=8648-000-1.4.1.S0
Firmware_Image_File=8648-000-1.4.1.S0.fw
Firmware_Reboot=1
Global_Configuration_State=0
Global_Configuration_File=8648-000-1.1.0.S0.save
Global_Configuration_Reboot=0
Specific_Configuration_State=0
Specific_Configuration_Reboot=0
```

2. If AUTO_PROVISION_VER is biggest than current auto provision version, do step 3; otherwise, wait 24 hours and go back to step 1.
3. If the Firmware_Upgrade_State =1, do step 4; otherwise, do step 6.

4. If the Firmware_Version is difference than current firmware version, download the Firmware_Image_File and upgrade firmware.
5. If upgrade firmware succeeded and Firmware_Reboot=1, let reboot_flag=1.
6. If the Global_Configuration_State =1, download the Global_Configuration_File and upgrade configuration; otherwise, do step 8.
7. If upgrade configutation succeeded and Global_Configuration_Reboot =1, let reboot_flag=1.
8. If the Specific_Configuration_State =1, download the specific configuration file and upgrade configuration; otherwise do step 10. The naming is “Model_Name _” with 12-bit MAC digits ,example for following is “8648-A_00e04c8196b9.txt”
9. If upgrade configutation succeeded and Specific_Configuration_Reboot =1, let reboot_flag=1.
10. If reboot_flag=1, save running configuration and reboot the switch; otherwise, wait 24 hours and go back to step 1.

Default Settings

Auto provision configuration profile:

```

Active           : Disable
Version          : 0
Protocol         : FTP
FTP user/pwd     : /
Folder           :
Server address   :
  
```

9.5.1 CLI Configurations

Node	Command	Description
enable	show auto-provision	This command displays the current auto provision configurations.
enable	configure terminal	This command changes the node to configure node.
configure	auto-provision	This command enters the auto-provision node.
auto-provision	show	This command displays the current auto provision configurations.
auto-provision	active (enable disable)	This command enables/disables the auto provision function.
auto-provision	server-addressIPADDR	This command configures the auto provision server’s IP.
auto-provision	protocol (tftp http ftp)	The command configurations the upgrade protocol.
auto-provision	FTP-user username	The command configurations the username and

	STRING password STRING	password for the FTP server.
auto-provision	folder STRING	The command configurations the folder for the auto provision server.
auto-provision	no folder	The command configurations the folder to default.
auto-provision	no FTP-user	The command configurations the username and password to default.

9.5.2 Web Configurations

Auto Provision

Auto Provision Settings

State	<input type="text" value="Disable"/>
Status	Disabled
Version	0
Protocol	<input type="text" value="TFTP"/>
Server IP	<input type="text" value="IPv4"/>
	<input type="text" value="0.0.0.0"/>
Username	<input type="text"/>
User Password	<input type="password" value="*****"/>
Folder Path	<input type="text"/>

9.6 Mail Alarm

The feature sends an e-mail trap to a predefined administrator when some events occur. The events are listed below:

- ◆ System Reboot : The system warm start or cold start.
- ◆ Port Link Change : A port link up or down.
- ◆ Configuration Change : The system configurations in the NV-RAM have been updated.
- ◆ Firmware Upgrade : The system firmware image has been updated.
- ◆ User Login : A user login the system.
- ◆ Port Blocked : A port is blocked by looping detection or BPDU Guard.

Default Ports	Server	Authentication	Port
SMTP Server (Outgoing Messages)	Non-Encrypted	AUTH	25 (or 587)
	Secure (TLS)	StartTLS	587
	Secure (SSL)	SSL	465
POP3 Server (Incoming Messages)	Non-Encrypted	AUTH	110
	Secure (SSL)	SSL	995
Googlemail - Gmail	Server:	Authentication:	Port:
SMTP Server (Outgoing Messages)	smtp.gmail.com	SSL	465
	smtp.gmail.com	StartTLS	587
POP3 Server (Incoming Messages)	pop.gmail.com	SSL	995
Outlook.com	Server:	Authentication:	Port:
SMTP Server (Outgoing Messages)	smtp.live.com	StartTLS	587
POP3 Server (Incoming Messages)	pop3.live.com	SSL	995
Yahoo Mail	Server:	Authentication:	Port:
SMTP Server (Outgoing Messages)	smtp.mail.yahoo.com	SSL	465
POP3 Server (Incoming Messages)	pop.mail.yahoo.com	SSL	995
Yahoo Mail Plus	Server:	Authentication:	Port:
SMTP Server (Outgoing Messages)	plus.smtp.mail.yahoo.com	SSL	465
POP3 Server (Incoming Messages)	plus.pop.mail.yahoo.com	SSL	995

9.6.1 CLI Configurations

Node	Command	Description
enable	show mail-alarm	This command displays the Mail Alarm configurations.
enable	configure terminal	This command changes the node to

		configure node.
configure	mail-alarm (disable enable)	This command disables / enables the Mail Alarm function.
configure	mail-alarm auth-account	This command configures the Mail server authentication account.
configure	mail-alarm mail-from	This command configures the mail sender.
configure	mail-alarm mail-to	This command configures the mail receiver.
configure	mail-alarm server (ip ipv6 domain-name) STRINGS server-port VALUE	This command configures the mail server IP address / domain name and the TCP port.
configure	mail-alarm server (ip ipv6 domain-name) STRINGS server-port default	This command configures the mail server IP address / domain name and configures 25 as the server's TCP port.
configure	mail-alarm trap-event (reboot link-change config. firmware login port-blocked alarm) (disable enable)	This command disables / enables mail trap events.
configure	mail-alarm utf8-encoding (disable enable)	This command disables / enables the UTF8 encoding for mail content.

9.6.2 Web Configurations

Mail Alarm

Mail Alarm Settings

State: Disable ▾

Server: IPv4 ▾ Server Port: (Default:25)

Account Name: Account Password:

Mail From:

Mail To:

UTF-8 Encoding: Enable ▾

Mail Event State:

Select All Deselect All

- Alarm
- Firmware Upgrade
- Port Blocked
- Port Link Change
- System Reboot
- User Login

Parameter	Description
-----------	-------------

State	Enable / disable the Mail Alarm function.
Server	Selects one of below options: IP: The mail server's IP format is IPv4. IPv6: The mail server's IP format is IPv6. Domain Name: The mail server's IP format is a domain name.
Server Port	Specifies the TCP port for the SMTP server.
Account Name	Specifies the mail account name.
Account Password	Specifies the mail account password.
Mail From	Specifies the mail sender.
Mail To	Specifies the mail receiver.
UTF-8 Encoding	Enable / disable the UTF-8 encoding for mail content.
Mail Event State	Enables / disables the mail trap event states.
Apply	Click Apply to take effect the settings.
Refresh	Click Refresh to begin configuring this screen afresh.

9.7 Maintenance

9.7.1 Configuration

9.7.1.1 CLI Configurations

Node	Command	Description
enable	configure terminal	This command changes the node to configure node.
configure	write memory	This command writes current operating configurations to the configuration file.
configure	archive download-config <URL PATH>	This command downloads a new copy of configuration file to replace the <i>startup-config</i> from TFTP server. Where <URL PATH> can be: ftp://user:pass@192.168.1.1/file http://192.168.1.1/file tftp://192.168.1.1/file
configure	archive upload-config <URL PATH>	This command uploads the current <i>startup-config</i> configurations file to a TFTP server.
configure	archive download-running-config <URL PATH>	This command downloads a new copy of running configuration file from TFTP server. Where <URL PATH> can be: ftp://user:pass@192.168.1.1/file http://192.168.1.1/file tftp://192.168.1.1/file

configure	reload default-config	This command copies a <i>user-default-config</i> file to replace the <i>startup-config</i> file. Note: The system will reboot automatically to take effect the configurations.
configure	archive download-config URL_PATH user-default-config	This command downloads configure file to <i>user-default-config</i> .
configure	copy factory-default-config to user-default-config	This command copies <i>factory-default-config</i> file to <i>user-default-config</i> file.
configure	copy startup-config to user-default-config	This command copies the <i>startup-config</i> file to <i>user-default-config</i> file.

There are three configuration files:

- *startup-config*.
 - *user-default-config*.
 - *factory-default-config*.
- When users execute the command, *write memory*, the system will save all of the running configurations to *startup-config* file.
 - When the Switch boot up, it will load *startup-config* as the system configurations.
 - When users execute the command, *reload default-config*, the system will copy *user-default-config* to *startup-config*.
 - How to build your own default configuration file?
 1. You can prepare a configuration file and then do below command,
archive download-config URL_PATH user-default-config
 2. You can login the system with console/Telnet/Http. And then follow below procedures:
 - To setup all configurations what you want.
 - Do the command, *write memory*, to save them to *startup-config* file.
 - Do the command, *copy startup-config to user-default-config*, to copy *startup-config* file to *user-default-config* file.
 - The *factory-default-config* file for user special propose.

9.7.1.2 Web Configurations

Maintenance

Configuration **Firmware** **Reboot** **Server Control**

Save Configurations

Save the parameter settings of the Switch.

Upload and Download Configurations.

Upload configuration file to your Switch.
File Path No file chosen

Press Download button to save configuration file to your PC.

Reset Configurations

Reset the factory default settings of the Switch.
- IP address will be 192.168.0.254

Save Configurations

Save Configurations

Save the parameter settings of the Switch :

Press the Save button to save the current settings to the NV-RAM (flash).

Upload / Download Configurations to /from a your server

Upload and Download Configurations

Upload configuration file to your Switch.
File path No file chosen

Press "Download" to save configuration file to your PC.

Follow the steps below to save the configuration file to your PC.

- Select the “Press “Download” to save configurations file to your PC”.
- Click the “Download” button to start the process.

Follow the steps below to load the configuration file from your PC to the Switch.

- Select the “Upload configurations file to your Switch”.
- Select the full path to your configuration file.
- Click the Upload button to start the process.

Reset the factory default settings of the Switch

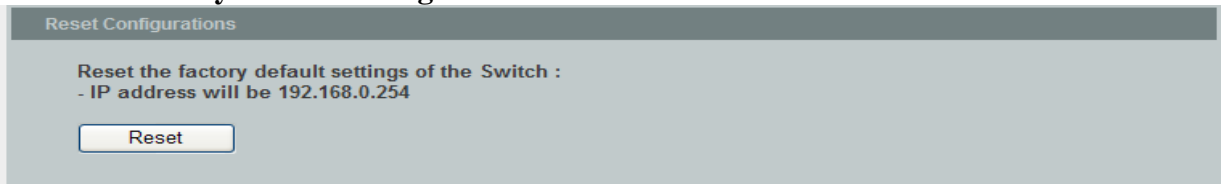

Press the Reset button to set the settings to factory default configurations.

9.7.2 Firmware

9.7.2.1 CLI Configurations

Node	Command	Description
enable	configure terminal	This command changes the node to configure node.
configure	archive download-fw <URL PATH>	This command downloads a new copy of firmware file from TFTP / FTP / HTTP server. Where <URL PATH> can be: ftp://user:pass@192.168.1.1/file http://192.168.1.1/file tftp://192.168.1.1/file
configure	archive ipv6-download-fw <URL PATH>	This command downloads a new copy of firmware file from IPv6 TFTP / FTP / HTTP server. Where <URL PATH> can be: ftp://user:pass@192.168.1.1/file http://192.168.1.1/file tftp://192.168.1.1/file
configure	archive download-secondary-fw <URL PATH>	This command downloads a new copy of firmware file for secondary image from TFTP / FTP / HTTP server. Where <URL PATH> can be: ftp://user:pass@192.168.1.1/file http://192.168.1.1/file tftp://192.168.1.1/file
configure	archive ipv6-download-secondary-fw <URL PATH>	This command downloads a new copy of firmware file for secondary image from IPv6 TFTP / FTP / HTTP server. Where <URL PATH> can be: ftp://user:pass@192.168.1.1/file http://192.168.1.1/file tftp://192.168.1.1/file

9.7.2.2 Web Configurations

Type the path and file name of the firmware file you wish to upload to the Switch in the **File path** text box or click **Browse** to locate it. Click **Upgrade** to load the new firmware.

Maintenance

Configuration

Firmware

Reboot

Server

Upgrade Firmware

File Path

Choose File

No file chosen

Upgrade

9.7.3 Reboot

9.7.3.1 CLI Configurations

Node	Command	Description
enable	configure terminal	This command changes the node to configure node.
configure	reboot	This command reboots the system.

9.7.3.2 Web Configurations

Reboot allows you to restart the Switch without physically turning the power off. Follow the steps below to reboot the Switch.

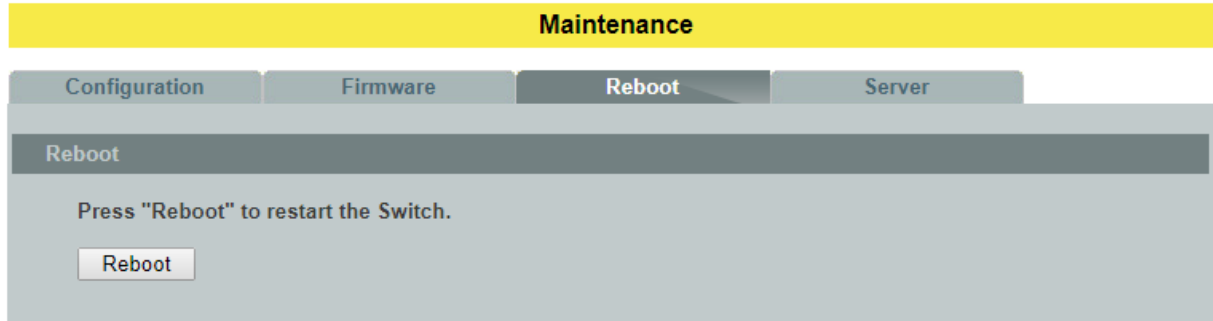

- In the **Reboot** screen, click the **Reboot** button. The following screen displays.

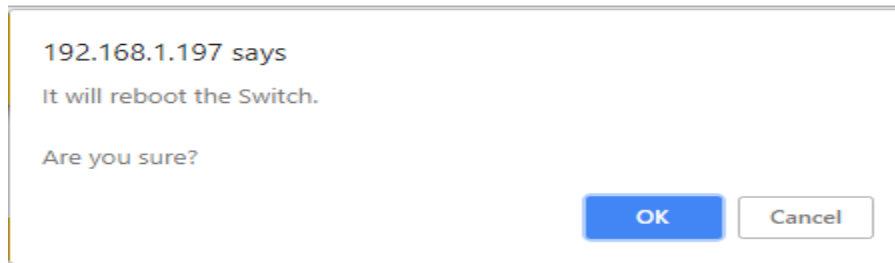

- Click **OK** again and then wait for the Switch to restart. This takes up to two minutes. This does not affect the Switch's configuration.

9.7.4 Server Control

The function allows users to enable or disable the SSH or Telnet or Web service individual using the CLI or GUI.

9.7.4.1 CLI Configurations

Node	Command	Description
enable	show server status	This command displays the current server status.
enable	configure terminal	This command changes the node to configure node.
configure	http server	This command enables the http on the Switch.
configure	no http server	This command disables the http on the Switch.
configure	http server port VALUE	This command configures the TCP port for the HTTP server.
configure	no http server port	This command resets the HTTP TCP port to 80.
configure	https server	This command enables the https on the Switch.
configure	no https server	This command disables the https on the Switch.
configure	ssh server	This command enables the ssh on the Switch.
configure	no ssh server	This command disables the ssh on the Switch.
configure	telnet server	This command enables the telnet on the Switch.
configure	no telnet server	This command disables the telnet on the Switch.
configure	telnet server port VALUE	This command configures the TCP port for the TELNET server.
configure	no telnet server port	This command resets the TELNET TCP port to 23.

9.7.4.2 Web Configurations

Maintenance

Configuration
Firmware
Reboot
Server

Server Settings

HTTP Server State	<input type="button" value="Enable ▼"/>	HTTP Server TCP Port	<input type="text" value="80"/> (80,1025~9999)
HTTPS Server State	<input type="button" value="Enable ▼"/>		
SNMP v1/v2c Server State	<input type="button" value="Enable ▼"/>		
SNMP v3 Server State	<input type="button" value="Enable ▼"/>		
SSH Server State	<input type="button" value="Enable ▼"/>		
TELNET Server State	<input type="button" value="Enable ▼"/>	TELNET Server TCP Port	<input type="text" value="23"/> (23,1025~9999)

Server Status

HTTP Server Status	Enabled	HTTP Server TCP Port	80
HTTPS Server Status	Enabled		
SNMP v1/v2c Server Status	Enabled		
SNMP v3 Server Status	Enabled		
SSH Server Status	Enabled		
TELNET Server Status	Enabled	TELNET Server TCP Port	23

Parameter	Description
Server Settings	
HTTP Server State	Selects Enable or Disable to enable or disable the HTTP service.
HTTP Server TCP Port	Configures the TCP port for the HTTP service.
SSH Server State	Selects Enable or Disable to enable or disable the SSH service.
Telnet Server State	Selects Enable or Disable to enable or disable the Telnet service.
TELNET Server TCP Port	Configures the TCP port for the Telnet service.
Apply	Click Apply to take effect the settings.
Refresh	Click Refresh to begin configuring this screen afresh.

9.8 Syslog

The syslog function records some of system information for debugging purpose. Each log message recorded with one of these levels, **Alert / Critical / Error / Warning / Notice / Information**. The syslog function can be enabled or disabled. The default setting is disabled. The log message is recorded in the Switch file system. If the syslog server's IP address has been configured, the Switch will send a copy to the syslog server.

The log message file is limited in 4KB size. If the file is full, the oldest one will be replaced.

9.8.1 CLI Configurations

Node	Command	Description
enable	show syslog	The command displays the entire log message recorded in the Switch.
enable	show syslog level LEVEL	The command displays the log message with the LEVEL recorded in the Switch.
enable	show syslog server	The command displays the syslog server configurations.
enable	configure terminal	This command changes the node to configure node.
configure	clear syslog	The command clears the syslog message.
configure	syslog-server (disable enable)	The command disables / enables the syslog server function.
configure	syslog-server ipv4-ip IPADDR	The command configures the syslog server's IP address in IPv4 format.
configure	syslog-server ipv6-ip IPADDR	The command configures the syslog server's IP address in IPv6 format.
configure	syslog-server facility	The command configures the syslog facility level.
configure	archive upload-syslog <URL PATH>	This command uploads the syslog file to a TFTP server.
configure	archive ipv6-upload-syslog <URL PATH>	This command uploads the syslog file to a IPv6 TFTP server.

Example:

```
L2SWITCH#configure terminal
L2SWITCH(config)#syslog-server ipv4-ip 192.168.200.106
L2SWITCH(config)#syslog-server enable
```

9.8.2 Web Configurations

Syslog

Syslog Server Settings

Server IP

Facility

Syslog

Log Level

```

<4> 2020 Jan 1 00:00:26 40006:Port 8 Link Up.
<6> 2020 Jan 1 00:00:26 60003:System Cold Start!
<6> 2020 Jan 1 00:00:34 befd58e4:User(admin) Login Succeeded!
<6> 2020 Jan 1 00:00:56 60005:Save configurations to file!
<6> 2020 Jan 1 00:02:12 60001:User(q) Login Succeeded!
<4> 2020 Jan 1 00:02:49 4001d:Update System Firmware Succeeded!
<6> 2020 Jan 1 00:00:24 60004:System Warm Start!
<4> 2020 Jan 1 00:00:25 40006:Port 8 Link Up.
```

Parameter	Description
Server IP	Select IP type for the server's IP. Enter the Syslog server IP address. Select Enable to activate switch sent log message to Syslog server when any new log message occurred.
Facility	Selects the facility level..
Apply	Click Apply to take effect the settings.
Refresh	Click Refresh to begin configuring this screen afresh.
Log Level	Select Alert/Critical/Error/Warning/Notice/Information to choose which log message to want to see.
Clear	Click Clear to clear all of log message.
Save	Click Save to save all of log message into NV-RAM.

9.9 USB Function

The USB Function is used on a network switch for automatic execution of tasks, such as firmware upgrade, download configurations and system log.

9.9.1 CLI Configurations

Node	Command	Description
enable	show usb status	This command displays the current USB function configurations.
enable	configure terminal	This command changes the node to configure node.
configure	usb auto-upgrade-fw (disable enable)	This command disables / enables the USB upgrade firmware automatically.
configure	usb auto-download-config (disable enable)	This command disables / enables the USB download configuration file automatically..
configure	usb auto-download-syslog (disable enable)	This command disables / enables the USB download syslog file automatically.

Example :

- L2SWITCH#show usb status
 - USB auto upgrade firmware State : Enabled
 - USB auto download config State : Enabled
 - USB auto download syslog State : Enabled
- L2SWITCH#*configure terminal*
- L2SWITCH(config)#usb auto-upgrade-fw enable
- L2SWITCH(config)#usb auto-download-config enable
- L2SWITCH(config)#usb auto-download-syslog enable

9.9.2 Web Configurations

USB Functions

USB Flash Drive Auto Function Settings

Function	State
Auto Upgrade Firmware	Disable ▼
Auto Download Configure File	Disable ▼
Auto Download Syslog File	Disable ▼
Auto Upload Configure File	Disable ▼

Parameter	Description
Auto Upgrade Firmware	Select Enable to turn on automatic upgrade firmware or select Disable to turn it off.
Auto Download Config	Select Enable to turn on automatic download configurations or select Disable to turn it off.
Auto Download Syslog	Select Enable to turn on automatic download system log or select Disable to turn it off.
Apply	Click Apply to take effect the settings.
Refresh	Click Refresh to begin configuring this screen afresh.

9.10 User Account

The Switch allows users to create up to 6 user account. The user name and the password should be the combination of the digit or the alphabet. The last admin user account cannot be deleted. Users should input a valid user account to login the CLI or web management.

User Authority:

The Switch supports two types of the user account, admin and normal. The **default** user's account is **username(admin) / password(admin)**.

- admin - read / write.
- normal - read only.
; Cannot enter the privileged mode in CLI.
; Cannot apply any configurations in web.

The Switch also supports backdoor user account. In case of that user forgot their user name or password, the Switch can generate a backdoor account with the system's MAC. Users can use the new user account to enter the Switch and then create a new user account.

Default Settings

Maximum user account : 6.
Maximum user name length : 32.
Maximum password length : 32.
Default user account for privileged mode : admin / admin.

Notices

The Switch allows users to create up to 6 user account.
The user name and the password should be the combination of the digit or the alphabet.
The last admin user account cannot be deleted.
The maximum length of the username and password is 32 characters.

9.10.1 CLI Configurations

Node	Command	Description
enable	show user account	This command displays the current user accounts.
enable	show dot1x username	This command displays the dot1x user accounts.
configure	add user USERNAME PASSWORD (normal admin dot1x)	This command adds a new user account with choice of privileges normal/admin/dot1x .
configure	delete user USERNAME	This command deletes a present user account.
configure	dot1x username USERNAME PASSWORD	This command creates a user account for DOT1X local authentication.
configure	no dot1x username USERNAME	This command removed a user account for DOT1X local authentication.

Example:

```
L2SWITCH#configure terminal
L2SWITCH(config)#add user q q admin
L2SWITCH(config)#add user 1 1 normal
```

9.10.2 Web Configurations

User Account

User Account Settings

User Name

User Password

User Authority Admin ▾

User Account List

No.	User Name	User Authority	Action
1	admin	Admin	<input type="button" value="Delete"/>
2	admin	dot1x	
3	q	Admin	<input type="button" value="Delete"/>

Parameter	Description
User Account Settings	
User Name	Type a new username or modify an existing one.
User Password	Type a new password or modify an existing one. Enter up to 32 alphanumeric or digit characters.
User Authority	Select with which group the user associates: admin (read and write) or normal (read only) for this user account.
Apply	Click Apply to take effect the settings.
Refresh	Click Refresh to begin configuring this screen afresh.
User Account List	
Action	Click Delete to remove the user account. Note: You cannot delete the last admin accounts.

9.11 Device management

9.11.1 LLDP

The Link Layer Discovery Protocol (LLDP) specified in this standard allows stations attached to an IEEE 802[®] LAN to advertise, to other stations attached to the same IEEE 802 LAN, the major capabilities provided by the system incorporating that station, the management address or addresses of the entity or entities that provide management of those capabilities, and the identification of the station's point of attachment to the IEEE 802 LAN required by those management entity or entities.

The information distributed via this protocol is stored by its recipients in a standard Management Information Base (MIB), making it possible for the information to be accessed by a Network Management System (NMS) using a management protocol such as the Simple Network Management Protocol (SNMP).

9.11.1.1 CLI Configurations

Node	Command	Description
enable	show lldp	This command displays the LLDP configurations.
enable	show lldp neighbor	This command displays all of the ports' neighbor information.
enable	configure terminal	This command changes the node to configure node.
configure	lldp (disable enable)	This command globally enables / disables the LLDP function on the Switch.
configure	lldp tx-interval	This command configures the interval to transmit the LLDP packets.
configure	lldp tx-hold	This command configures the tx-hold time which determines the TTL of the Switch's message. (TTL=tx-hold * tx-interval)
configure	interface IFNAME	This command enters the interface configure node.
interface	lldp-agent (disable enable rx-only tx-only)	This command configures the LLDP agent function. disable – Disable the LLDP on the specific port. enable – Transmit and Receive the LLDP packet on the specific port. tx-only – Transmit the LLDP packet on the specific port only. rx-only – Receive the LLDP packet on the specific port.
config	interface range gigabitethernet1/0/ PORTLISTS	This command enters the if-range configure node.
if-range	lldp-agent (disable enable rx-only tx-only)	This command configures the LLDP agent function. disable – Disable the LLDP on the specific port. enable – Transmit and Receive the LLDP packet on the specific port. tx-only – Transmit the LLDP packet on the specific port only. rx-only – Receive the LLDP packet on the specific port.

9.11.1.2 Web Configurations

Device Management

LLDP
Manual Registration
ONVIF

LLDP Settings

State Enable ▾

Tx Interval 30 seconds (Range: 1-3600)

Tx Hold 4 times (Range: 2-100)

Time To Live 120 seconds

LLDP Neighbor Information

Local Port 1	
Remote Port ID	GigabitEthernet1/0/2
Chassis ID	00-0b-04-00-00-08
System Name	INS-8648M
System Description	Volktek Corp./INS-8648M/V1.1.2.S0/Fri Nov 13 15:37:02 CST 2020
System Capabilities	Bridge/Switch (enabled)
Management IP	0.0.0.0

Local Port 2	
Remote Port ID	GigabitEthernet1/0/1
Chassis ID	00-0b-04-14-0e-9d
System Name	L2SWITCH
System Description	Volktek Corp./MEN-3410/V1.1.8.R1/Nov 19 09:02:08 CST 2020
System Capabilities	Bridge/Switch (enabled)
Management IP	192.168.202.112

Parameter	Description
LLDP Settings	
State	Globally enables / disables the LLDP on the Switch.
Tx Interval	Configures the interval to transmit the LLDP packets.
Tx Hold	Configures the tx-hold time which determines the TTL of the Switch's message. (TTL=tx-hold * tx-interval)
Time To Live	The hold time for the Switch's information.
Apply	Click Apply to take effect the settings.
Refresh	Click Refresh to begin configuring this screen afresh.

LLDP Neighbor Information	
Local Port	The local port ID.
Remote Port ID	The connected port ID.
Chassis ID	The neighbor's chassis ID.
System Name	The neighbor's system name.
System Description	The neighbor's system description.
System Capabilities	The neighbor's capability.
Management IP	The neighbor management address.

9.11.2 Manual Registration

If devices do not support LLDP and ONVIF, user has to enter the details of it by manually under manual registration. The function supports four types, IP-Cam, PLC, Switch and PC.

9.11.2.1 CLI Configurations

Node	Command	Description
enable	show manual-registration-device	This command displays the manual registration device configurations.
enable	configure terminal	This command changes the node to configure node.
configure	manual-registration-device type (ipcam plc switch pc) mac MACADDR ip IPADDR product-name STRINGS system-name STRINGS	This command configures a device for the Topology Map.
configure	no manual-registration-device mac MACADDR	This command removes a device from the Topology Map.

9.11.2.2 Web Configurations

Device Management

LLDP
Manual Registration
ONVIF

Manual Registration Settings

Type	MAC Address	IP	Product Name	System Name
IP-Cam ▼	<input type="text"/>	<input type="text"/>	<input type="text"/>	<input type="text"/>

Manual Registration Table

Type	MAC Address	IP	Product Name	System Name	Action
IP-Cam	00:0b:04:11:22:34	192.168.202.154	Justin_PC	L2SWITCH	<input type="button" value="Delete"/>

Parameter	Description
Manual Registration Settings	
Type	The kind of devices connected to switch.
MAC Address	The MAC address of the device.
Product Name	The product name of the device.

System Name	The system name of the device.
Apply	Click Apply to take effect the settings.
Refresh	Click Refresh to begin configuring this screen afresh.
Manual Registration Table	
Action	Clicks Delete to delete this device.

9.11.3 ONVIF

9.11.3.1 CLI Configurations

Node	Command	Description
enable	show onvif	This command displays the ONVIF configurations.
enable	configure terminal	This command changes the node to configure node.
config	onvif enable	This command enables the ONVIF on the Switch.
config	onvif tx-interval <6-3600>	This command configures the tx interval for the ONVIF.
config	no onvif enable	This command disables the ONVIF on the Switch.
config	no onvif tx-interval	This command reset the tx interval to default for the ONVIF.(Default: 6 seconds).

9.11.3.2 Web Configurations

Device Management

LLDP
Manual Registration
ONVIF

ONVIF Settings

State: ▾

Tx Interval(sec): (6~3600)

ONVIF Neighbors

Parameter	Description
ONVIF Settings	
State	Select option to enable / disable the ONVIF feature on the Switch.
Tx Interval	Configures the sending ONVIF discovery packet interval. Valid range is 6 ~ 3600 seconds.
Apply	Click Apply to take effect the settings.
Refresh	Click Refresh to begin configuring this screen afresh.
ONVIF Neighbor Information	
Port	The connected port of the ONVIF device.
IP Address	The IP address of the ONVIF device.

MAC Address	The MAC address on the ONVIF device.
VLAN ID	The VLAN ID of the ONVIF device join.
Product Name	Name of the product added.
Product Type	What kind of product that is added.
Model	Model of the product.
Location	Location where it is placed.
Web Service Address	Address of the web service of that camera.

9.12 Topology Map

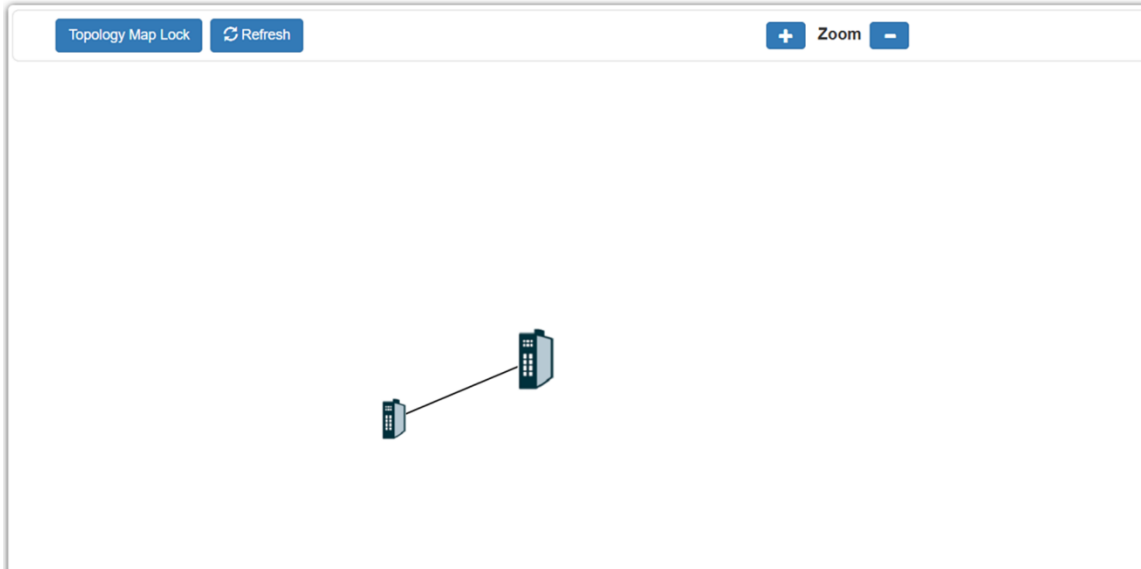

When you click the “Topology Map Lock”, the screen will appear as below:
The green circle on the devices indicates they are working normally.

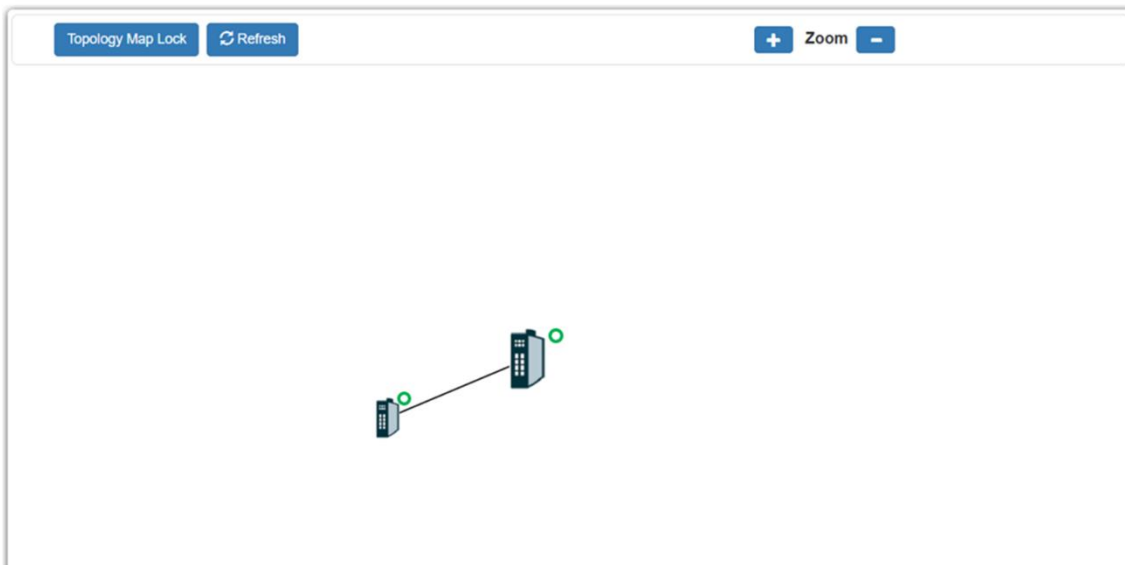

You can view the basic details of the devices connected to the host, by placing the cursor on it.

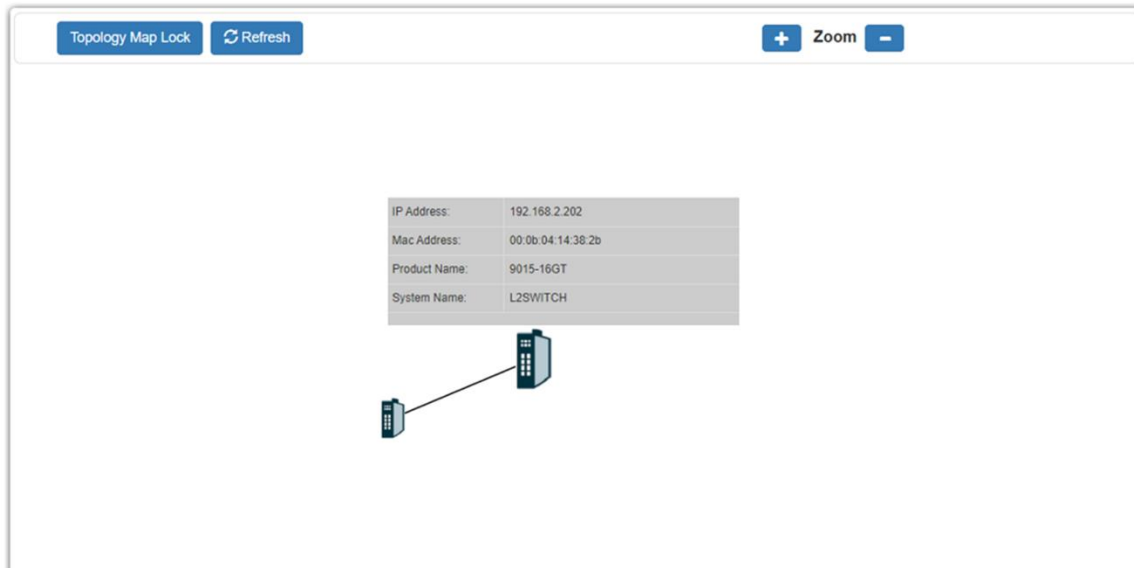

When there is something wrong with the devices (IEN-8415PL), the screen will appear as below. So that you can find the details of events that have gone wrong, and correct it.

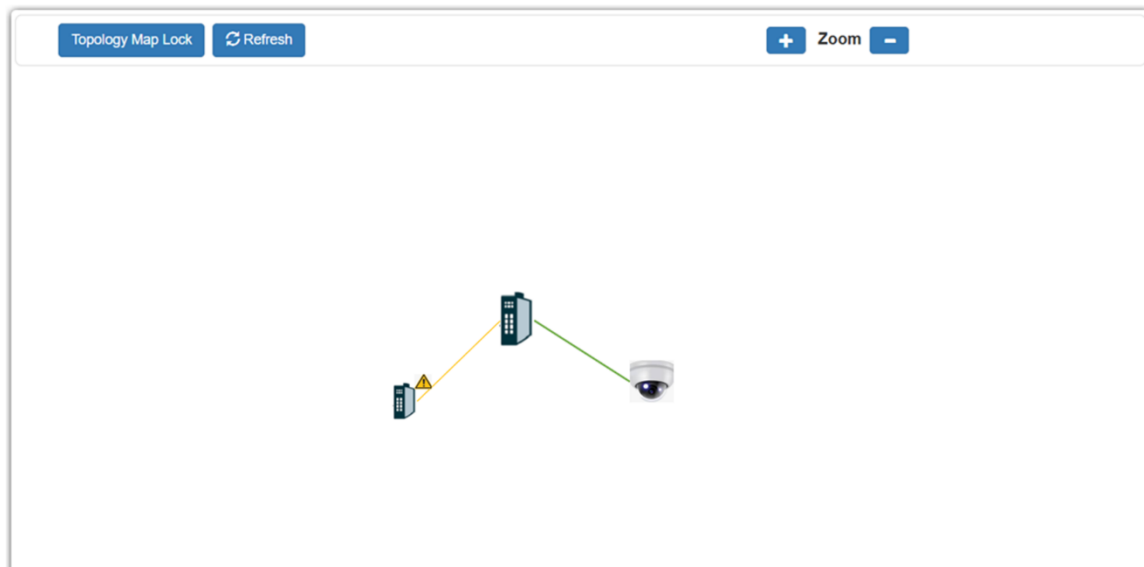

The red 'X' indicates that connection is lost with the host.

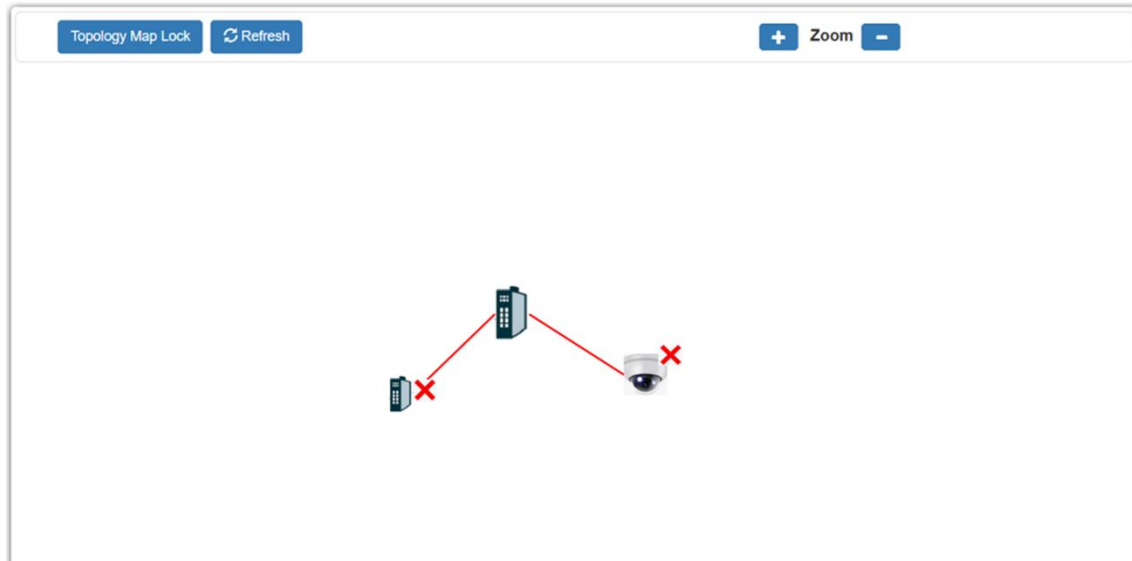

9.12.1 Background Configuration

You can upload your company floor layout plan picture in to the background image so that you can identify easily where the switches has been placed.

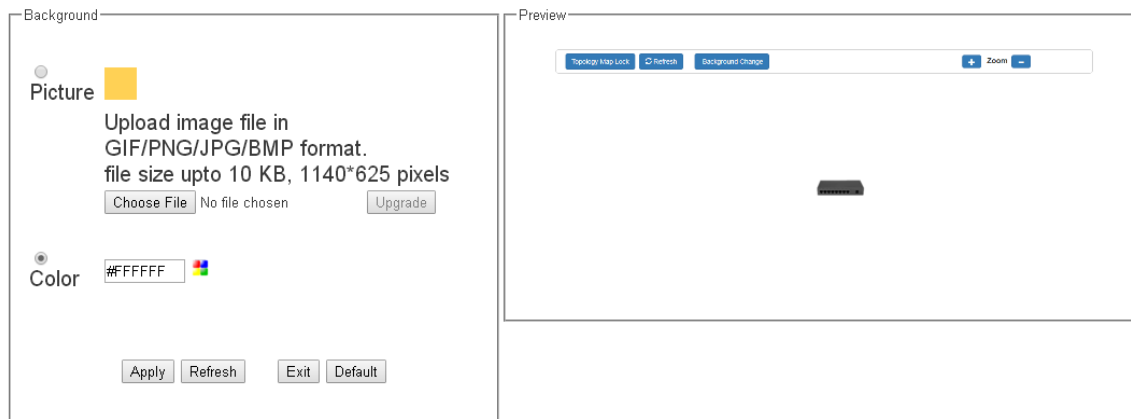

- **Picture**
To choice a file which you want to display it in the background and the Preview window will display your select immediately. If you click the “Upgrade” button, the file will be download to the Switch and it will be applied on next reboot.
- **Color**
Allow user to select standard color for the background and the Preview window will display your select immediately.

9.12.2 Client-Switch Management

By Right clicking on the neighbor non-Lite management switch (MEN-5410) you get this menu and you can configure as shown below.

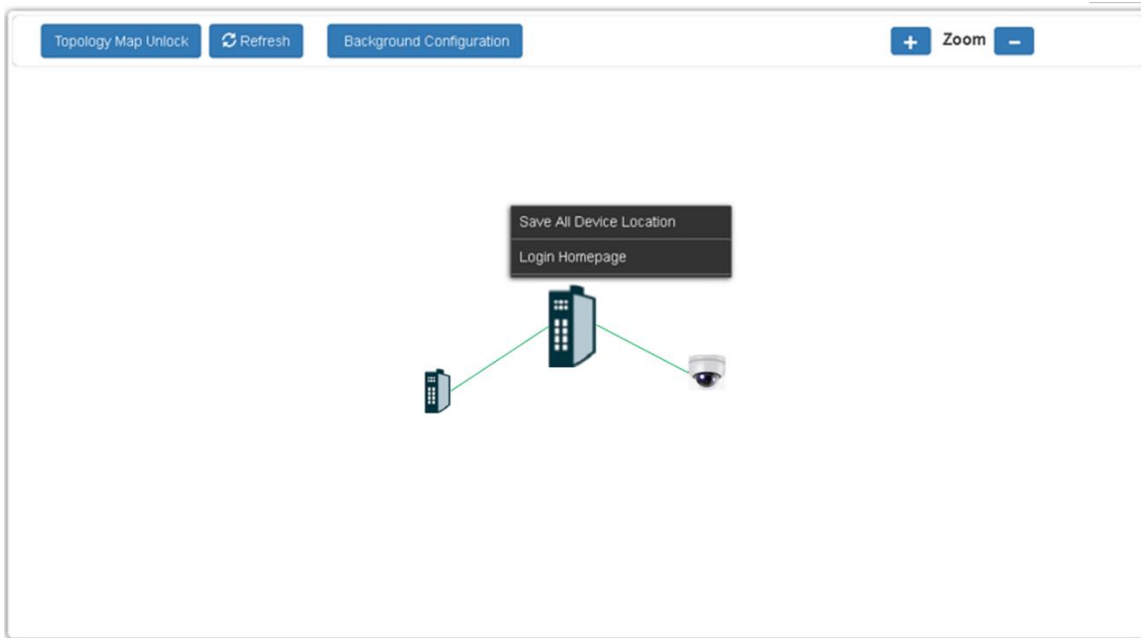

Non-Lite management switch and other devices menu:

- Save All Device Location
 - ✓ To fix the location of all devices on the map, so that it restores its places after refresh.
- Login Homepage
 - To login to the client device Homepage, and make necessary changes after entering suitable username and password.

10 MISC

10.4 Cable Test

This feature determines the quality of the cables, shorts, and cable impedance mismatch, bad connectors, termination mismatch, and bad magnetics. The feature can work on the copper Ethernet cable only. The cable testers can measure the signal strength and attenuation of the cable during transmission.

Note: Cable tester can only accesable through the CLI without any GUI support.

10.4.1 CLI Configurations

Node	Command	Description
Enable	configure terminal	This command changes the node to configure node.
configure	interface IFNAME	This command enters the interface configure node.
Interface	show cable-test result	This command displays the cable test result.
Interface	cable-test start	This command starts to test the cable.

11 Volktek Support

11.4 Contact Information

QR scanner will provide the complete contact information along with below complete contact information will be available with respect to Volktek branches addresses

Contact Info

QR code



Headquarters

4F, 192 Liancheng Rd, Zhonghe District, New Taipei 23553, Taiwan

Tel : +886-2- 8242-1000

Fax : +886-2- 8242-3333

E-mail : info@volktek.com

Zhunan Factory

17-1 Guotai Rd. Zhunan, Miaoli 35057, Taiwan

Tel : +886-37- 550288

E-mail : info@volktek.com

India

5th Floor, Janardana Plaza, 62, Hitech City Main Rd, Lumbini Avenue, Beside Euro School,
Gachibowli, Hyderabad, Telangana, 500032, India

Tel : +91 720705 6161/6262

Fax : +91 40 2300-1078

E-mail : info@volktek.com

USA

9059 Technology Lane, Suite 121, Fishers, IN 46038, USA

E-mail : USA@volktek.com

Germany

E-mail : Germany@volktek.com

Sweden

E-mail : Sweden@volktek.com

Singapore

E-mail : Singapore@volktek.com

Spain

E-mail : Spain@volktek.com

11.5 FAQ's

FAQ's option will redirect to the page where user will get some of the commonly answered questions

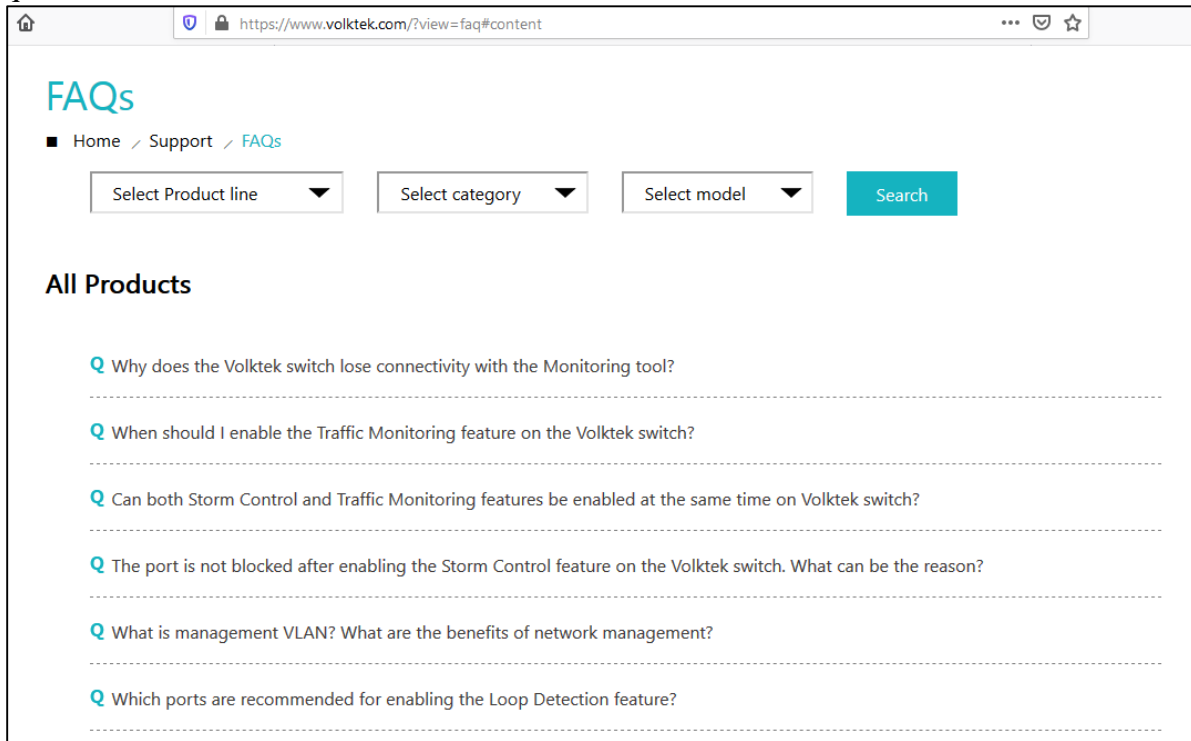

11.6 Manual

Clicks the QR Code to download the user manual. Please make sure that the internet connection is available.

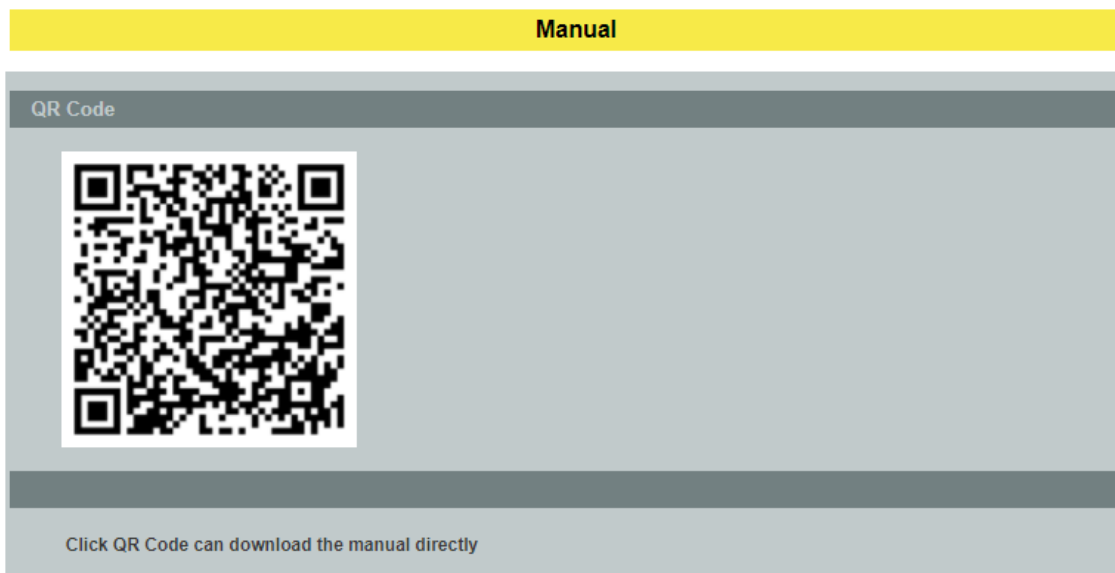

11.7 Support

QR scanner along with support Email ID is available in this option

Support

QR code



E-mail

E-mail : Support@volktek.com

11.8 Volktek Website

This particular option will redirect it to Volktek official website <https://www.volktek.com/>

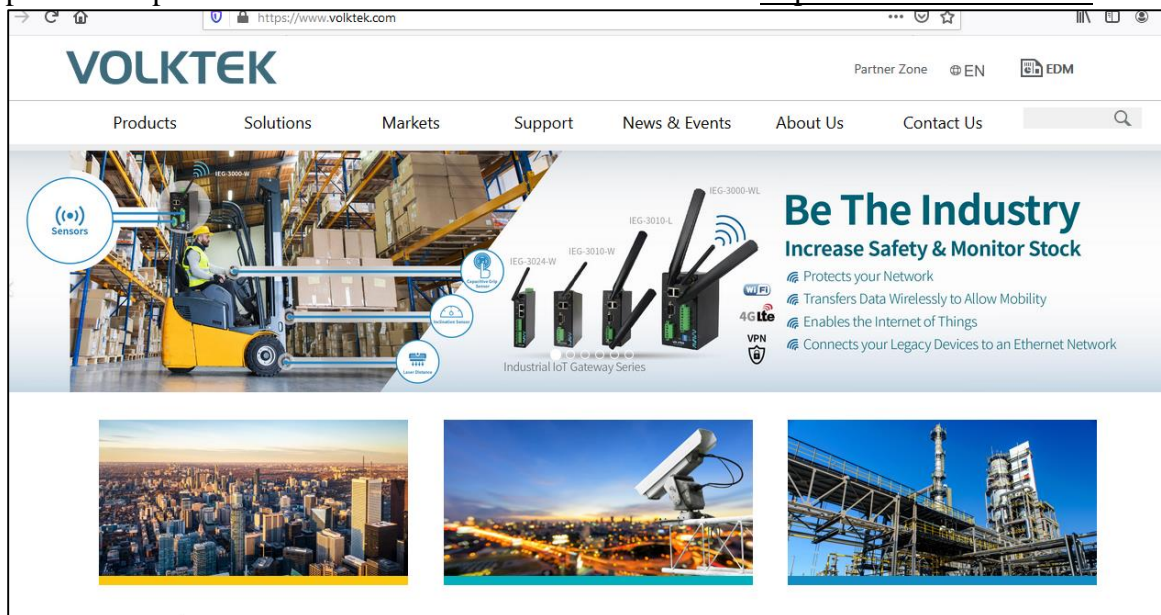

The screenshot shows the Volktek website homepage. At the top, the 'VOLKTEK' logo is on the left, and 'Partner Zone', 'EN', and 'EDM' are on the right. A navigation menu includes 'Products', 'Solutions', 'Markets', 'Support', 'News & Events', 'About Us', and 'Contact Us'. The main banner features a forklift in a warehouse with 'Sensors' and 'Industrial IoT Gateway Series' (models IEG-3024-W, IEG-3010-W, IEG-3010-L, and IEG-3000-WL) highlighted. The headline reads 'Be The Industry Increase Safety & Monitor Stock'. Below this, four key features are listed: 'Protects your Network', 'Transfers Data Wirelessly to Allow Mobility', 'Enables the Internet of Things', and 'Connects your Legacy Devices to an Ethernet Network'. The bottom of the page has three image tiles: a city skyline, a surveillance camera, and an industrial facility.